

THIS DRAWING IS UNPUBLISHED. RELEASED FOR PUBLICATION .19  
 COPYRIGHT 19 BY AMP INCORPORATED. ALL RIGHTS RESERVED.

LOC	DIST	REVISIONS			
P	LTR	DESCRIPTION	DATE	DWN	APVD
J		REVISED ECR-10-002537	04FEB2010	JC	TAP

NOTES:

- 1 MATERIAL  
 HOUSING: HIGH TEMPERATURE THERMOPLASTIC GLASS FILLED.  
 UL94V-0, REGRIND 25% MAXIMUM  
 CONTACT: COPPER ALLOY  
 BOARDLOCK: COPPER ALLOY
- 2 FINISH  
 CONTACT: 0.76um MIN GOLD ON MATING AREA AND  
 1.91um MIN TIN (LEAD-FREE) ON SOLDER AREA,  
 BOTH OVER 1.27um MIN NICKEL  
 BOARDLOCK: 2.54um MIN TIN OVER 1.27um MIN NICKEL

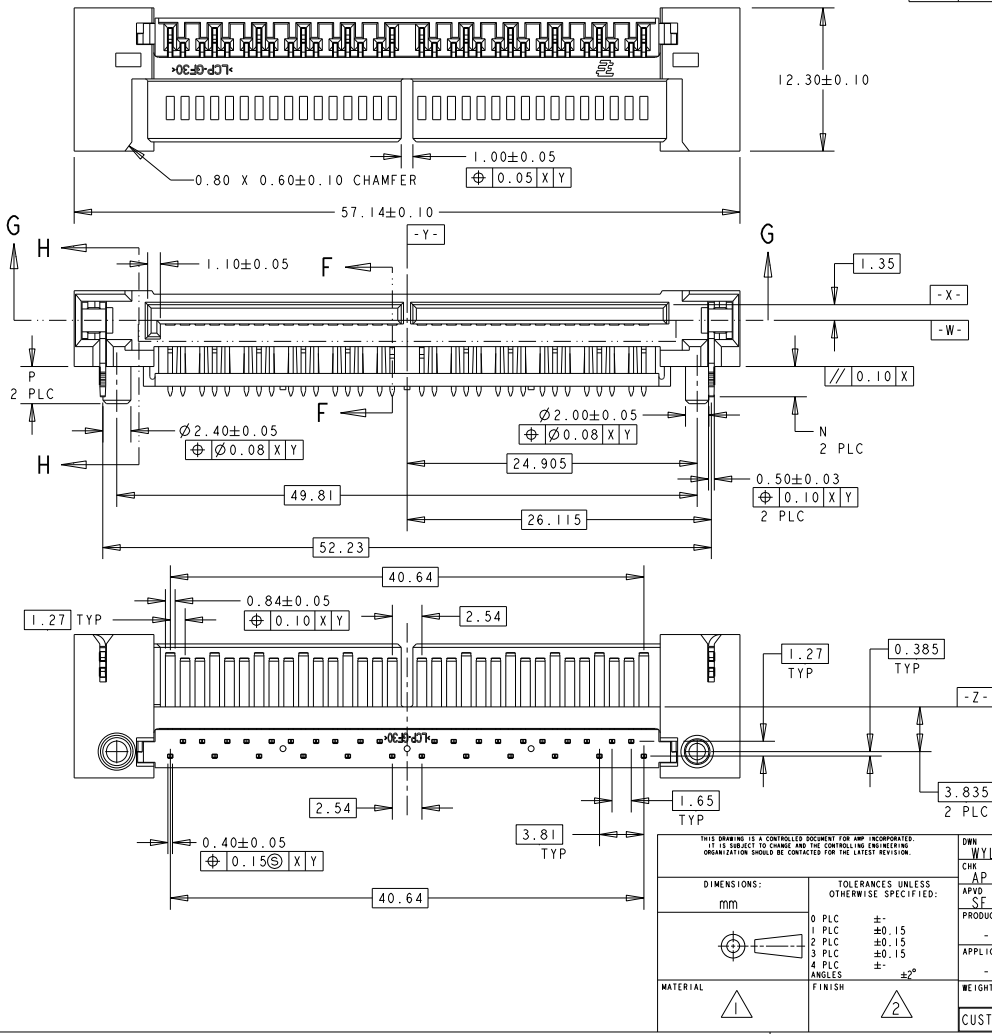
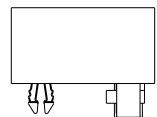

<small>THIS DRAWING IS A CONTROLLED DOCUMENT FOR AMP INCORPORATED.                  IT IS SUBJECT TO CHANGE AND THE CONTROLLING ENGINEERING                  ORGANIZATION SHOULD BE CONTACTED FOR THE LATEST REVISION.</small>		DWN WYILEE 12FEB2004 CHK AP TAY APVD SF LEONG PRODUCT SPEC - APPLICATION SPEC - WEIGHT - CUSTOMER DRAWING	Tyco Electronics Singapore Pte. Ltd. NAME CONNECTOR, SAS 4i AND INTERNAL 4 LANE SATA PLUG, R/A THROUGH HOLE SIZE A3 CAGE CODE 00779 DRAWING NO C-84980 SCALE 3:1 SHEET 1 OF 3 REV J
DIMENSIONS: mm 	TOLERANCES UNLESS OTHERWISE SPECIFIED: 0 PLC ± 1 PLC ±0.15 2 PLC ±0.15 3 PLC ±0.15 4 PLC ± ANGLES ±2°	MATERIAL 1 FINISH 2	

4

3

2

1

THIS DRAWING IS UNPUBLISHED. RELEASED FOR PUBLICATION .19  
 BY AMP INCORPORATED. ALL RIGHTS RESERVED.

LOC	DIST	REVISIONS					
DY	-	P	LTR	DESCRIPTION	DATE	DWN	APVD
		SEE SHEET 1					

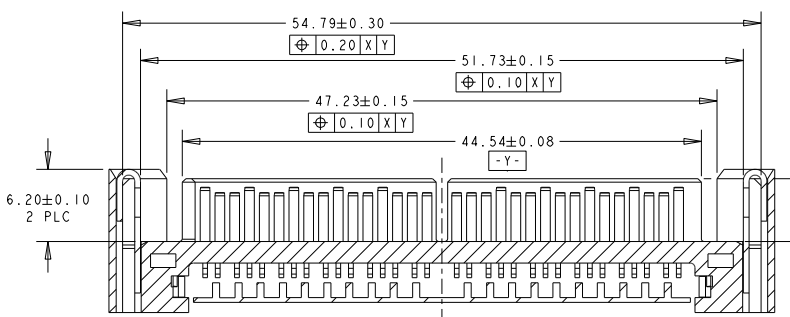
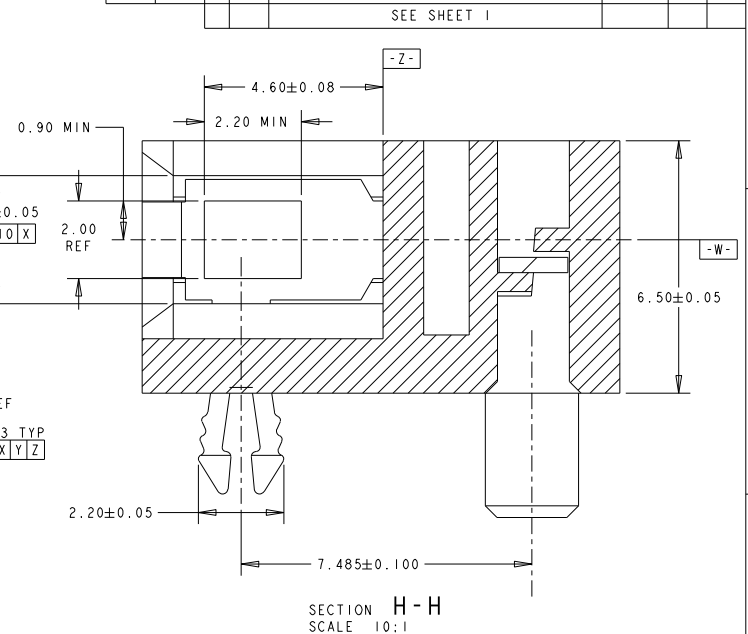
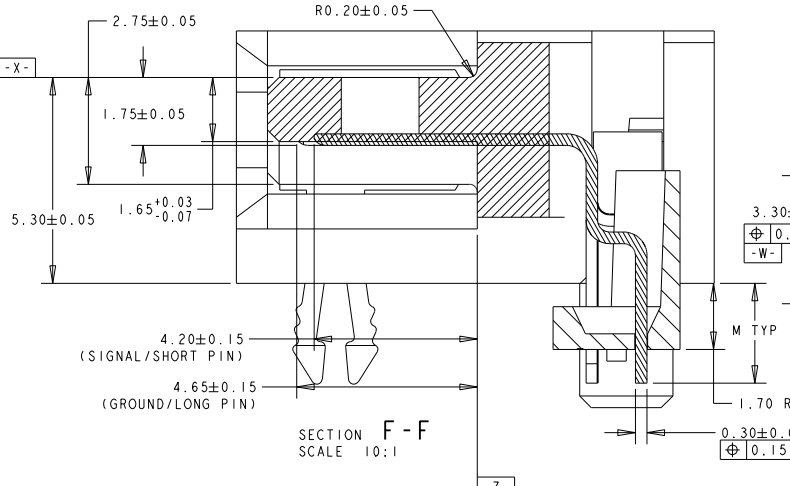

NATURAL	1.57±0.10	3.20	2.60	2.54	16+16P	84980-5
BLACK	3.18±0.10	4.00	4.35	4.06	16+16P	84980-4
BLACK	1.57±0.10	3.20	2.60	2.54	16+16P	84980-3
BLACK	3.18±0.10	4.00	4.35	4.06	16+16P	84980-2
BLACK	1.57±0.10	3.20	2.60	2.15	16+16P	84980-1
COLOR	PCB THICKNESS	P	N	M	POS.	PART NO.

OBSOLETE  
OBSOLETE

SECTION G-G

THIS DRAWING IS A CONTROLLED DOCUMENT FOR AMP INCORPORATED. IT IS SUBJECT TO CHANGE AND THE CONTROLLING ENGINEERING ORGANIZATION SHOULD BE CONTACTED FOR THE LATEST REVISION.

DIMENSIONS:	TOLERANCES UNLESS OTHERWISE SPECIFIED:	DWN	12FEB2004	Tyco Electronics Singapore Pte. Ltd.	
mm		CHK	WYLER	NAME	
	0 PLC ±	APV	AP TAY	CONNECTOR, SAS 4i AND INTERNAL 4 LANE SATA PLUG, R/A THROUGH HOLE	
	1 PLC ±0.15	PRODUCT SPEC	SF LEONG	SIZE	CAGE CODE
	2 PLC ±0.15	APPLICATION SPEC		A3	00779
	3 PLC ±0.15	WEIGHT		DRAWING NO	G-84980
	4 PLC ±	CUSTOMER DRAWING		SCALE	3:1
	ANGLES ±°			SHEET	2 of 3
MATERIAL	FINISH			REV	J

AMP 1470-19 REV 09MAY94

4

3

2

1

THIS DRAWING IS UNPUBLISHED. RELEASED FOR PUBLICATION . . . 19 . . .  
 BY AMP INCORPORATED. ALL RIGHTS RESERVED.

LOC	DIST	REVISIONS			
P	LTR	DESCRIPTION	DATE	DWN	APVD
DY	-	SEE SHEET 1			

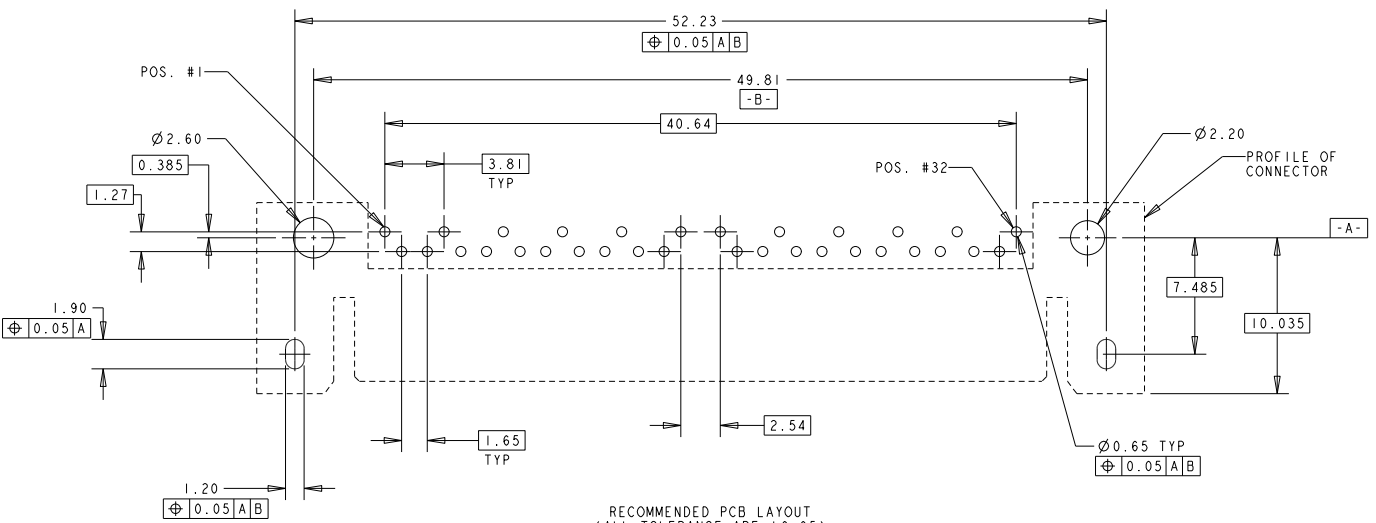

RECOMMENDED PCB LAYOUT  
 (ALL TOLERANCES ARE ±0.05)  
 SCALE 4:1

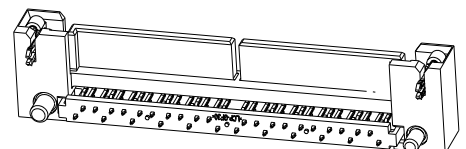

ISOMETRIC VIEW  
 SCALE 2:1

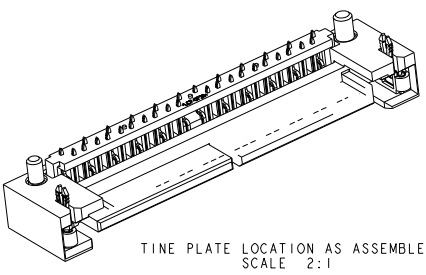

TINE PLATE LOCATION AS ASSEMBLED  
 SCALE 2:1

<small>THIS DRAWING IS A CONTROLLED DOCUMENT FOR AMP INCORPORATED. IT IS SUBJECT TO CHANGE AND THE CONTROLLING ENGINEERING ORGANIZATION SHOULD BE CONTACTED FOR THE LATEST REVISION.</small>		DWN WYLER 12FEB2004 CHK AP TAY APVD SF LEONG	<b>Tyco Electronics</b> Singapore Pte. Ltd.
DIMENSIONS: mm 	TOLERANCES UNLESS OTHERWISE SPECIFIED: 0 PLC ±. 1 PLC ±0.15 2 PLC ±0.15 3 PLC ±0.15 4 PLC ±. ANGLES ±°	NAME CONNECTOR, SAS 4i AND INTERNAL 4 LANE SATA PLUG, R/A THROUGH HOLE	SIZE A3 CAGE CODE 00779 DRAWING NO. C-84980
MATERIAL 	FINISH 	WEIGHT CUSTOMER DRAWING	SCALE 3:1 SHEET 3 OF 3 REV J

AMP 1470-19 REV 09MAY94