

NUMBERS C-1734058

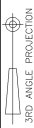

METRIC

THIS INFORMATION IS CONFIDENTIAL AND IS DISCLOSED TO YOU ON CONDITION THAT YOU WILL NOT REPRODUCE OR DISSEMINATE IT TO OTHER THAN AMP PERSONNEL WITHOUT WRITTEN AUTHORIZATION FROM AMP (TAYO) LTD. DIMENSIONS IN MILLIMETERS. DO NOT SCALE PRINT.

PRINT DW

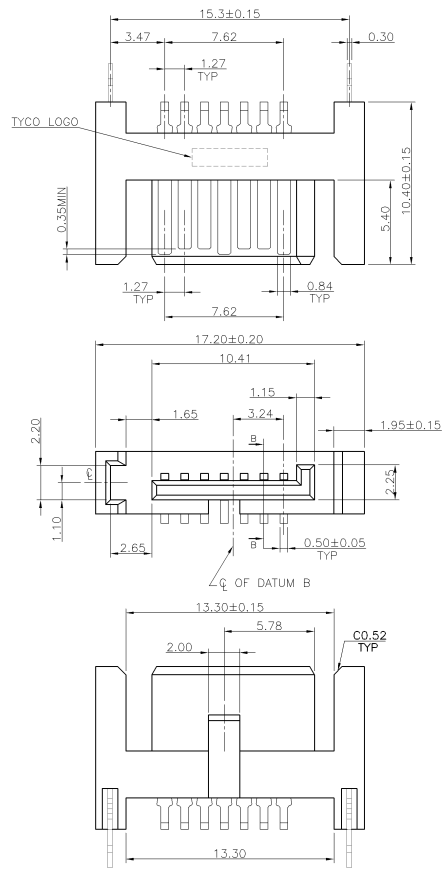
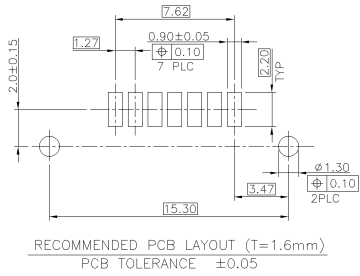

NOTE:

1. MATERIAL:
HOUSING: THERMOPLASTIC (LCP) WITH 30% GF, UL 94V-0, BLACK COLOR.
CONTACTS: BRASS.
BOARDLOCKS: BRASS.
2. FINISH:
CONTACTS: (SEE TABLE) GOLD PLATED ON CONTACT AREA, 100μ² MIN. MATTE-TIN ON SOLDER TAIL, WITH ENTIRE CONTACT UNDERPLATED 50μ² MIN. NICKEL.
BOARDLOCKS: 100μ² MIN. MATTE-TIN OVER 50μ² MIN. NICKEL.
3. REFLOW SOLDER CAPABLE TO 260°C AS PER TYCO SPEC. 109-201, CONDITION B.
4. NO DATE CODE ON THE PRODUCT.

3.30	15μ ²	1734058-4
	30μ ²	1734058-3
2.45	15μ ²	1734058-2
	GOLD FLASH	1734058-1
DIM L	GOLD PLATING	PART NUMBER

TOLERANCES UNLESS OTHERWISE SPECIFIED: 0 PLC ± - 1 PLC ±0.3 2 PLC ±0.25 3 PLC ±0.2 ANGLES # 3°	DWN A. WU 06-JUN-2006 CHK S. HOU 06-JUN-2006	tyco TYCO HOLDINGS (BERMUDA) VII LTD. TAIWAN BRANCH Electronics NAME
MATERIAL	APVD W.J. KE 06-JUN-2006	SERIAL ATA, 7 POS., PLUG, VERTICAL, SMT TYPE.
SEE NOTE	PRODUCT SPEC 108-57261	LOC DW A3
SEE NOTE	APPLICATION SPEC - WEIGHT 0.7 g	DRAWING NO C-1734058 REV A

A	ADD PART NUMBER	ECR-06-013611	AW SH	06JUN 2006
O	NEW RELEASED	--	AW SH	01APR 2005
LTR	REVISION RECORD	ECN	DWN CHK	DATE

CUSTOMER DRAWING 1 OF 2

NUMBERS C-1734058



METRIC

THIS INFORMATION IS CONFIDENTIAL AND IS DISCLOSED TO YOU ON CONDITION THAT YOU WILL NOT REPRODUCE OR DISSEMINATE IT TO ANY OTHER PARTY WITHOUT THE WRITTEN AUTHORIZATION OF TYCO ELECTRONICS (TAIWAN) LTD. DIMENSIONS IN MILLIMETERS. DO NOT SCALE PRINT.

PRINT DW

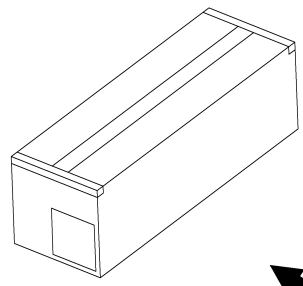

SHIPPING CARTON

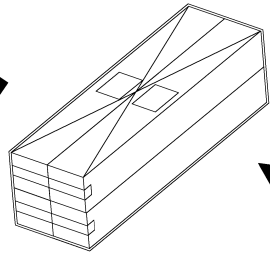

INNER CARTON

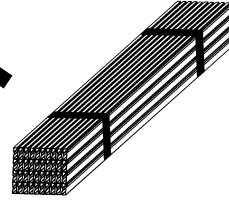

SHEAF

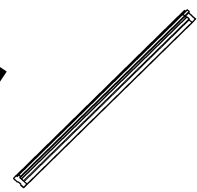

TUBE



PRODUCT

NOTE:
 1. DIMENSION
 TRAY: 460 X 7.5 X 15.8
 INNER CARTON: 485 X 86 X 72
 SHIPPING CARTON: 500 X 187 X 169
 2. QUANTITY
 25 PCS/TUBE
 40 TUBES/SHEAF
 1 SHEAF/INNER CARTON
 4 INNER CARTON/SHIPPING CARTON
 4000 PCS/SHIPPING CARTON
 3. WEIGHT:
 N.W: 5 KG
 G.W: 6 KG

TOLERANCES UNLESS OTHERWISE SPECIFIED: 0 PLC ± 1 PLC ± 2 PLC ± 3 PLC ± ANGLES #	DWN A. WU 06-JUN-2006	TYCO HOLDINGS (BERMUDA) VII LTD. TAIWAN BRANCH Electronics NAME
MATERIAL -	CHK S. HOU 06-JUN-2006	
FINISH -	APVD W.J. KE 06-JUN-2006	SERIAL ATA, 7 POS., PLUG, VERTICAL, SMT TYPE.
	PRODUCT SPEC -	LOC SIZE DRAWING NO DW A3 C-1734058
	APPLICATION SPEC -	SCALE SHEET -- 2 OF 2
	WEIGHT -	

SEE SHEET 1	ECN	DWN	CHK	DATE
LTR	REVISION RECORD			

CUSTOMER DRAWING 1

8 7 6 5 4 3 2

D
C
B
A