

10 9 8 7 6 5 4 3 2 1

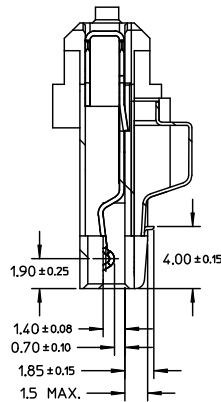
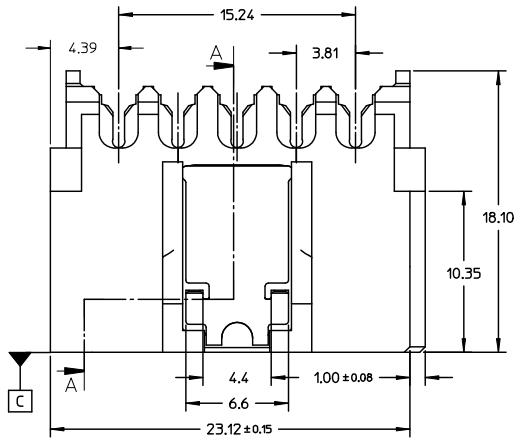

SECTION A-A

NOTES:

1. MATERIAL:
  - HOUSING: THERMAL PLASTIC, G.F., UL94V-0, COLOR: BLACK
  - COVER: THERMAL PLASTIC, COLOR: BLACK
  - TERMINAL: COPPER ALLOY
  - METAL LATCH: STAINLESS STEEL
2. TERMINAL PLATING:
  - CONTACT AREA: GOLD PLATED
  - IDT TAIL: PLATE TIN, 1.9 MICRONS MINIMUM
  - UNDER PLATE: PLATE NICKEL 1.25 MICRONS MINIMUM
3. PACKAGING: TRAY
4. PRODUCT SPECIFICATION REFER TO PS-67490-001
5. ASSEMBLE WITH COVER 679260040/0041 AFTER WIRE TERMINATION
6. MATING PART 87679
7. RECOMMENDED TERMINATING WIRE SIZE: SEE TABLE
8. PRODUCT COMPLIANT TO RoHS DIRECTIVE 2002/95/EC AND ELV DIRECTIVE 2000/53/EC

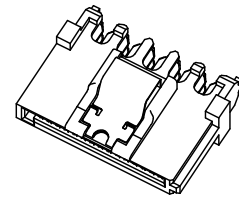

WITH LATCH TYPE

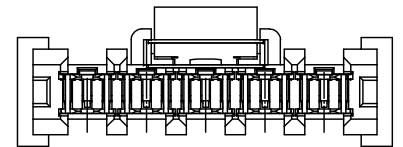
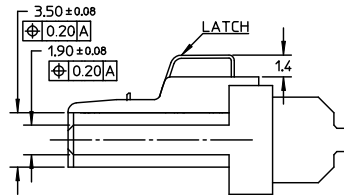
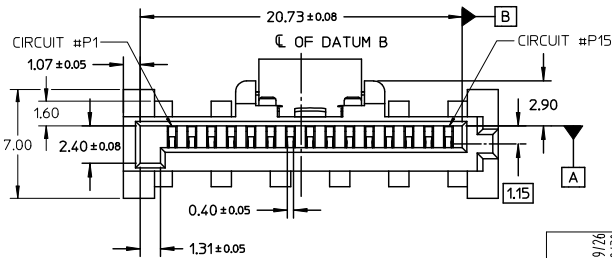

REVISED E.C. NO: SH2009-0098 2008/09/28 GDRW:WJWANG 2008/09/30 CHYK:XSJONG 2008/11/01 APPR:HMWANG 2008/11/01 DESCRIPTION REV	QUALITY SYMBOLS	GENERAL TOLERANCES (UNLESS SPECIFIED)	DIMENSION STYLE	SCALE	DESIGN UNITS	THIRD ANGLE PROJECTION
	▽=0 ▽=0	mm INCH 4 PLACES ± --- ± --- 3 PLACES ± --- ± --- 2 PLACES ± 0.25 ± --- 1 PLACE ± 0.3 ± --- ANGULAR ± 1°	MM ONLY	4:1	METRIC	
	DRAFT WHERE APPLICABLE MUST REMAIN WITHIN DIMENSIONS	DRAWN BY DATE GRATE MA 2004/01/17 CHECKED BY DATE YA JUN 2004/01/17 APPROVED BY DATE SAM 2004/01/17	TITLE	SERIAL ATA POWER CONNECTOR IDT TYPE		
	MATERIAL NO. SEE CHART	DOCUMENT NO. SD-67926-001	MOLEX INCORPORATED		SHEET NO.	1 OF 3

10 9 8 7 6 5 4 3 2 1

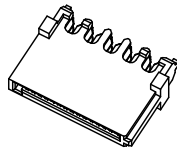
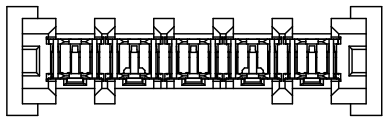

WITHOUT LATCH TYPE

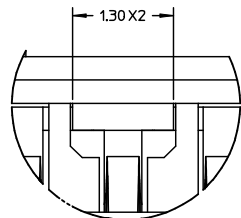
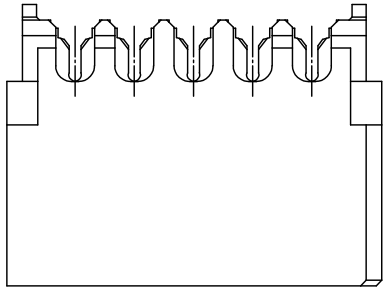

Detail2

SCALE 20:1

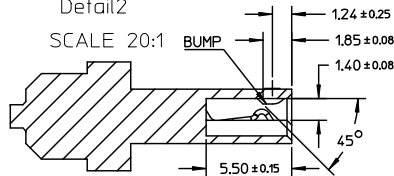

SECTION B-B

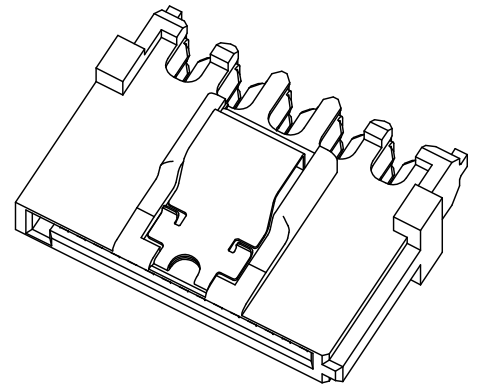

See Detail2

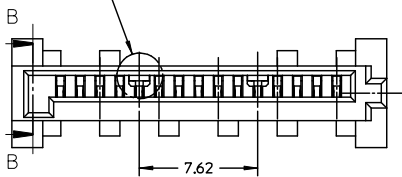

NOTES:  
OTHER INFORMATION REFER TO SHEET 1

REVISED IEC NO: SHZ009-0098 2008/09/26 G DRW:WWTANG 2008/09/30 CHYKX:JISONG APPR:HMANG 2008/11/01 DESCRIPTION REV	QUALITY SYMBOLS	GENERAL TOLERANCES (UNLESS SPECIFIED)	DIMENSION STYLE	SCALE	DESIGN UNITS	THIRD ANGLE PROJECTION	
	$\nabla=0$ $\nabla=0$	mm INCH 4 PLACES ± --- ± --- 3 PLACES ± --- ± --- 2 PLACES ± 0.25 ± --- 1 PLACE ± 0.3 ± --- ANGULAR ± 1°	MM ONLY	4:1	METRIC	DRAWN BY DATE GRATE MA 2004/01/17 CHECKED BY DATE YA JUN 2004/01/17 APPROVED BY DATE SAM 2004/01/17	
	DRAFT WHERE APPLICABLE MUST REMAIN WITHIN DIMENSIONS		SEE CHART	TITLE SERIAL ATA POWER CONNECTOR IDT TYPE MOLEX INCORPORATED		MATERIAL NO. SEE CHART	DOCUMENT NO. SD-67926-001
			SIZE A 3	THIS DRAWING CONTAINS INFORMATION THAT IS PROPRIETARY TO MOLEX INCORPORATED AND SHOULD NOT BE USED WITHOUT WRITTEN PERMISSION		SHEET NO. 2 OF 3	

tb\_frame\_A3\_P\_AM\_T  
Rev. D 2004/06/28

9 8 7 6 5 4 3 2 1

10 | 9 | 8 | 7 | 6 | 5 | 4 | 3 | 2 | 1

P/N	RECOMMENDED WIRE SIZE	PLATE TYPE	REMARK
67926-0001	18AWG	GOLD FLASH	WITH LATCH,WITHOUT BUMP
67926-0301	20AWG		
67926-0401	22AWG		
67926-0002	18AWG	0.76 MICRON GOLD PLATED	
67926-0302	20AWG		
67926-0402	22AWG		
67926-0005	18AWG	0.38 MICRON GOLD PLATED	
67926-0305	20AWG		
67926-0405	22AWG		
67926-0021	18AWG	GOLD FLASH	WITH LATCH,WITH BUMP
67926-0321	20AWG		
67926-0421	22AWG		
67926-0022	18AWG	0.76 MICRON GOLD PLATED	
67926-0322	20AWG		
67926-0422	22AWG		
67926-0025	18AWG	0.38 MICRON GOLD PLATED	
67926-0325	20AWG		
67926-0425	22AWG		
67926-0011	18AWG	GOLD FLASH	WITHOUT LATCH,WITH BUMP
67926-0311	20AWG		
67926-0411	22AWG		
67926-0012	18AWG	0.76 MICRON GOLD PLATED	
67926-0312	20AWG		
67926-0412	22AWG		
67926-0015	18AWG	0.38 MICRON GOLD PLATED	
67926-0315	20AWG		
67926-0415	22AWG		

<b>REVISED</b> EEC NO: SH2009-0098 2008/09/26 DRW:WWTANG 2008/09/30 CHK:KJLSONG APPR:HWANG 2008/11/01	QUALITY SYMBOLS ▽=0 ▽=0	GENERAL TOLERANCES (UNLESS SPECIFIED)		DIMENSION STYLE MM ONLY	SCALE 4:1	DESIGN UNITS METRIC	THIRD ANGLE PROJECTION		
		4 PLACES ± --- ± ---	mm INCH	DRAWN BY GRATE MA	DATE 2004/01/17	SERIAL ATA POWER CONNECTOR IDT TYPE			
		3 PLACES ± --- ± ---		CHECKED BY YA JUN	DATE 2004/01/17				
		2 PLACES ± 0.25 ± ---		APPROVED BY SAM	DATE 2004/01/17	MOLEX INCORPORATED SD-67926-001			
1 PLACE ± 0.3 ± ---		MATERIAL NO. SEE CHART		SHEET NO. 3 OF 3					
DRAFT WHERE APPLICABLE MUST REMAIN WITHIN DIMENSIONS		SIZE A3		THIS DRAWING CONTAINS INFORMATION THAT IS PROPRIETARY TO MOLEX INCORPORATED AND SHOULD NOT BE USED WITHOUT WRITTEN PERMISSION					

tb\_frame\_A3\_P\_AM.T  
Rev. E 2006/04/15

9 | 8 | 7 | 6 | 5 | 4 | 3 | 2 | 1