

MECHANICAL:

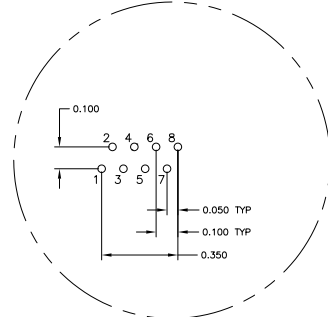

Pin Designations

726 SERIES MAGNETIC CIRCUIT

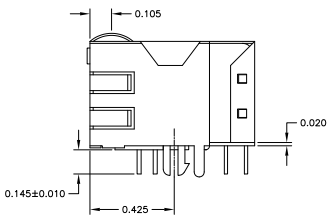
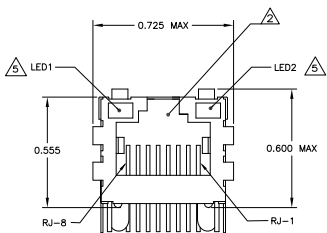
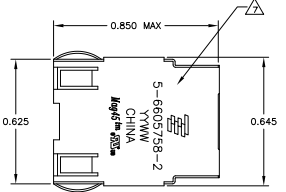
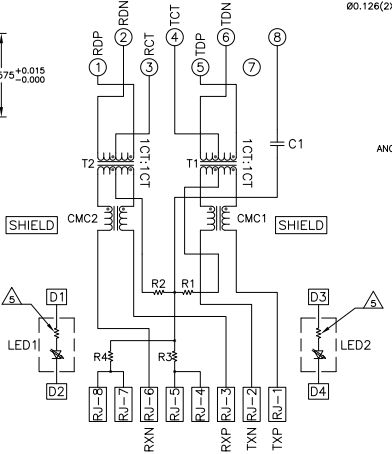

C1 = 1000pF, 2kV DECOUPLING CAPACITOR
R1-R4 = 75 OHMS, 1/16W, RESISTORS

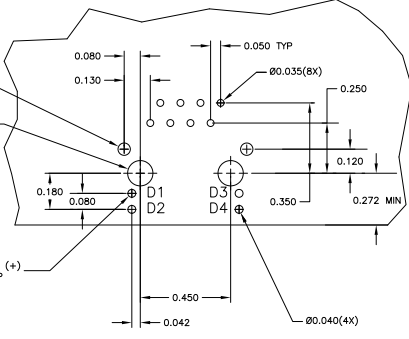

Suggested PCB Layout

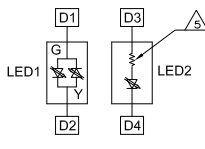

LED CONFIGURATION FOR 5-6605758-4 ONLY

- MATERIALS:**
- HOUSING - THERMOPLASTIC PET POLYESTER FLAMMABILITY RATING UL 94V-0.
 - SHIELD - .010" THICK, C26800 BRASS PREPLATED WITH 30µINCH MIN SEMI-BRIGHT NICKEL, SOLDER TABS POST DIPPED WITH 100µINCH MIN SAC SOLDER.
 - MOD JACK CONTACTS - 0.0157" x 0.018" PHOSPHOR BRONZE, 50µINCH MIN OVERALL NICKEL UNDERPLATE, WITH SELECT 50µINCH MIN HARD GOLD FINISH PLATE. SOLDER TAILS WITH 100µINCH MIN MATTE TIN AND/OR SAC SOLDER DIP.
 - LIGHT EMITTING DIODE(LED) - DIFFUSED EPOXY LENS, .020" x .020" CARBON STEEL WIREFRAME LEADS PRE-PLATED WITH 80µINCH SILVER OVER 40µINCH NICKEL UNDERPLATE OVER 40µINCH COPPER UNDERPLATE, POST-PLATED WITH 100µINCH MIN MATTE TIN AND/OR SAC SOLDER DIP OR PURE TIN SOLDER DIP.
- RJ45 JACK CAVITY CONFORMS TO FCC RULES AND REGULATIONS PART 68, SUB PART F.**
- MAGNETICS**
- IMPEDANCE: 100 OHMS
 - TURNS RATIO (CHP CABLE): TX = 11, RX = 11
 - OPEN CIRCUIT INDUCTANCE (OCL): 350nH MIN @100kHz, 0.1VRMS, 8mADC BIAS FROM 0°C TO 70°C, TX AND RX
 - PERFORMANCE @ 25°C
 - INSERTION LOSS (IL): 11dB MAX FROM 0.5MHz TO 100MHz
 - RETURN LOSS (RL): 18dB MIN FROM 0.5MHz TO 30MHz
 - 18-20LOG(f/30)dB MIN FROM 30.1MHz TO 60MHz
 - 12dB MIN FROM 60.1MHz TO 80MHz
 - CROSSTALK ATTENUATION: 35dB MIN FROM 0.5MHz TO 40MHz
 - 33-20LOG(f/50)dB MIN FROM 40.1MHz TO 100MHz
 - COMMON MODE REJECTION RATIO (CMRR): 30dB MIN FROM 0.5MHz TO 100MHz
 - ISOLATION VOLTAGE: COMPLIES WITH IEEE802.3 2002, PARA 23.5.1.1, ITEM b.
- 4. OPERATING TEMPERATURE FROM 0°C TO -70°C.**
- THE 250 OHM LED RESISTORS ARE OPTIONAL, PLEASE SEE CHART FOR PRESENCE OR ABSENCE OF LED RESISTORS. IF THE LED WITHOUT 250 OHM RESISTORS, LED IS DRIVEN WITH CONSTANT CURRENT AT APPROX 20mA.**
- LED COLOR: DOMINANT WAVELENGTH (AD): GREEN 568 nm TYP. at IF=20mA
FORWARD VOLTAGE (VF): GREEN 2.2V TYP. at IF=20mA
DOMINANT WAVELENGTH (AD): YELLOW 588 nm TYP. at IF=20mA
FORWARD VOLTAGE (VF): YELLOW 2.1V TYP. at IF=20mA
- IF THE LED WITH 250 OHM RESISTORS, LED IS DRIVEN WITH 5V VOLTAGE AND THE MAX OPERATING CURRENT IS 20mA.**
- LED COLOR: DOMINANT WAVELENGTH (AD): GREEN 568 nm TYP. at VF=5V
FORWARD CURRENT (IF): GREEN 12 mA TYP. at VF=5V
DOMINANT WAVELENGTH (AD): YELLOW 588 nm TYP. at VF=5V
- INDICATED CONNECTIONS ARE FOR NIC CONFIGURATION. THE MAGNETICS ARE SYMMETRICAL, AND SUPPORT AUTO-MDI/MDIX.**
- TYCO ELECTRONICS LOGO, PART NUMBER, DATE CODE, COUNTRY OF ORIGIN AND AGENCY APPROVAL MARKING IN APPROXIMATE LOCATION SHOWN.**
- 8. THESE PARTS ARE RECOMMENDED FOR WAVE SOLDERING PROCESS, PEAK WAVE SOLDERING TEMPERATURE IS 265°C MAX, 10 SECONDS MAX.**

YES	GREEN	YES	GREEN	YES	6-6605758-1
YES	YELLOW	NO	GREEN	NO	5-6605758-9
YES	GREEN	NO	YELLOW	NO	5-6605758-8
YES	GREEN	NO	GREEN	NO	5-6605758-7
YES	GREEN/YELLOW	YES	GREEN	YES	5-6605758-4
YES	YELLOW	YES	GREEN	YES	5-6605758-2
YES	GREEN	YES	YELLOW	YES	5-6605758-1
NO	GREEN	YES	GREEN	YES	1-6605758-1

2kV DECOUPLING CAPACITOR	LED1	255 OHMS RESISTOR	LED2	255 OHMS RESISTOR	PART NUMBER
--------------------------	------	-------------------	------	-------------------	-------------

THIS DRAWING IS A CONTROLLED DOCUMENT.		REV. NO.	DATE	DESCRIPTION	BY	CHKD
REV. NO.	DATE	DESCRIPTION	BY	CHKD	APPROVED	
1	108-2100	1X1 MAG45(TM), 7N2 SCHEMATIC, 726 SERIES CIRCUIT, OPTIONAL DECOUPLING CAPACITOR, SHIELDED, WITH LEADS.				
2						
3						
4						
5						
6						
7						
8						
9						
10						
11						
12						
13						
14						
15						
16						
17						
18						
19						
20						
21						
22						
23						
24						
25						
26						
27						
28						
29						
30						
31						
32						
33						
34						
35						
36						
37						
38						
39						
40						
41						
42						
43						
44						
45						
46						
47						
48						
49						
50						
51						
52						
53						
54						
55						
56						
57						
58						
59						
60						
61						
62						
63						
64						
65						
66						
67						
68						
69						
70						
71						
72						
73						
74						
75						
76						
77						
78						
79						
80						
81						
82						
83						
84						
85						
86						
87						
88						
89						
90						
91						
92						
93						
94						
95						
96						
97						
98						
99						
100						