

NOTES:

- MATERIAL:
  - HOUSING: GLASS FILLED NYLON, UL94V-0, COLOR: BLACK
  - INSULATOR: GLASS FILLED NYLON, UL94V-0, COLOR: BLACK
  - TERMINALS: PHOSPHOR BRONZE: .012/ 0.30 THICK
- FINISH:
  - TERMINALS:
    - SELECT GOLD IN CONTACT AREA: 50 MICRONS/ 1.27 MICROMETERS MIN.
    - \*SELECT TIN IN PC TAIL AREA: 100 MICRONS/ 2.54 MICROMETERS MIN.
    - WITH OVERALL NICKEL UNDERPLATE: 50 MICRONS/ 1.27 MICROMETERS MIN.
    - \*THE PRIMARY SHIPPING CARTON WILL BE LABELED 'COMPLIANT TO ROHS DIRECTIVE 2002/95/EC AND ELV ANNEX II OF DIRECTIVE 2000/53/EC'. CARTONS WITHOUT THIS LABEL MAY CONTAIN PRODUCT WITH TIN-LEAD IN THE PC TAIL AREA.
- PRODUCT SPECIFICATION AND PROCESSING PARAMETERS: PS-43223-001.
- PACKAGING SPECIFICATION:
  - UNSHIELDED CONNECTOR ASSEMBLIES PACKAGED IN TRAYS PER MOLEX PACKAGING SPECIFICATION PK-43249-004.
- SEE SHEETS 4-6 FOR P.C. BOARD LAYOUTS.
- SEE SHEET 2 FOR THE SHIELDED JACK ASSEMBLY.
- FOR 6 CIRCUIT JACKS CENTERLINE TO CENTERLINE SPACING IS .448/ 11.38, FOR 8 CIRCUIT JACKS CENTERLINE TO CENTERLINE SPACING IS .550/ 13.97.
- ALL UNTOLERANCED DIMENSIONS ARE SHOWN FOR REFERENCE ONLY.
- THIS PART CONFORMS TO CLASS B REQUIREMENTS OF COSMETIC SPECIFICATION PS-45499-002.

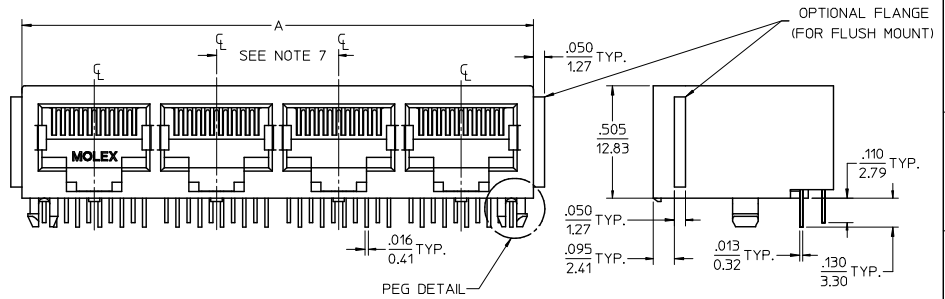

4 PORT 8 LOADED  
10 JACK SHOWN

UNSHIELDED GANGED JACK ASSEMBLY  
SEE SHEET 3

CENTER PEG  
(8 PORT ASSY. ONLY)

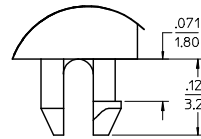

SNAP-FIT  
PEG DETAIL  
SCALE 8:1

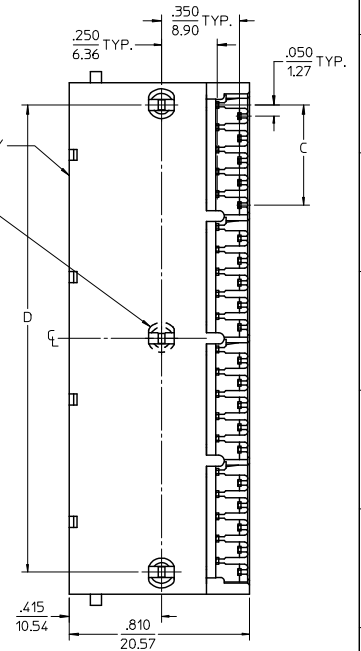

6 CIRCUIT HOUSING

CIRCUIT SIZE	NO. OF PORTS	DIM. A	DIM. C	DIM. D
6	2	.985 (25.02)	.250 (6.35)	.848 (21.54)
4	2	.985 (25.02)	.150 (3.81)	.848 (21.54)
2	2	.985 (25.02)	.050 (1.27)	.848 (21.54)
6	3	1.433 (36.40)	.250 (6.35)	1.296 (32.92)
4	3	1.433 (36.40)	.150 (3.81)	1.296 (32.92)
2	3	1.433 (36.40)	.050 (1.27)	1.296 (32.92)
6	4	1.881 (47.78)	.250 (6.35)	1.744 (44.30)
4	4	1.881 (47.78)	.150 (3.81)	1.744 (44.30)
2	4	1.881 (47.78)	.050 (1.27)	1.744 (44.30)
6	5	2.329 (59.16)	.250 (6.35)	2.192 (55.68)
4	5	2.329 (59.16)	.150 (3.81)	2.192 (55.68)
2	5	2.329 (59.16)	.050 (1.27)	2.192 (55.68)
6	6	2.777 (70.54)	.250 (6.35)	2.640 (67.06)
4	6	2.777 (70.54)	.150 (3.81)	2.640 (67.06)
2	6	2.777 (70.54)	.050 (1.27)	2.640 (67.06)
6	8	3.673 (93.29)	.250 (6.35)	3.536 (89.81)
4	8	3.673 (93.29)	.150 (3.81)	3.536 (89.81)
2	8	3.673 (93.29)	.050 (1.27)	3.536 (89.81)

8 CIRCUIT HOUSING

CIRCUIT SIZE	NO. OF PORTS	DIM. A	DIM. C	DIM. D
10	2	1.200 (30.48)	.450 (11.43)	1.000 (25.40)
8	2	1.200 (30.48)	.350 (8.89)	1.000 (25.40)
6	2	1.200 (30.48)	.250 (6.35)	1.000 (25.40)
10	3	1.750 (44.45)	.450 (11.43)	1.550 (39.37)
8	3	1.750 (44.45)	.350 (8.89)	1.550 (39.37)
6	3	1.750 (44.45)	.250 (6.35)	1.550 (39.37)
4	3	1.750 (44.45)	.150 (3.81)	1.550 (39.37)
10	4	2.300 (58.42)	.450 (11.43)	2.100 (53.34)
8	4	2.300 (58.42)	.350 (8.89)	2.100 (53.34)
4	4	2.300 (58.42)	.150 (3.81)	2.100 (53.34)
4	5	2.850 (72.39)	.150 (3.81)	2.650 (67.31)
10	5	2.850 (72.39)	.450 (11.43)	2.650 (67.31)
8	5	2.850 (72.39)	.350 (8.89)	2.650 (67.31)
10	6	3.400 (86.36)	.450 (11.43)	3.200 (81.28)
8	6	3.400 (86.36)	.350 (8.89)	3.200 (81.28)
10	8	4.500 (114.30)	.450 (11.43)	4.300 (109.22)
8	8	4.500 (114.30)	.350 (8.89)	4.300 (109.22)

ADD BLOCK TOL EC NO. IUP2009-0477 2008/09/05 DRWN:JBELL 2008/09/11 CHKD:JBELL 2008/09/11 APPR:SPWTH 2008/09/11	QUALITY SYMBOLS ▽=0 ▽=0	GENERAL TOLERANCES (UNLESS SPECIFIED)		DIMENSION STYLE IN/MM		SCALE 3:1	DESIGN UNITS INCH	THIRD ANGLE PROJECTION	
		4 PLACES ± --- ± --- 3 PLACES ± --- ± .015 2 PLACES ± 0.38 ± --- 1 PLACE ± --- ± ---	mm INCH	DRAWN BY JTR	DATE 1993/10/18	TITLE LOW PROFILE GANGED, RIGHT ANGLE MODULAR JACK ASSEMBLY			
		ANGULAR ±1/2°		CHECKED BY JTR	DATE 1993/10/18	MOLEX INCORPORATED			
		DRAFT WHERE APPLICABLE MUST REMAIN WITHIN DIMENSIONS		APPROVED BY RAS	DATE 1993/10/18	MATERIAL NO. SEE SHTS 3	DOCUMENT NO. SDA-43223	SHEET NO. 1 OF 6	

THIS DRAWING CONTAINS INFORMATION THAT IS PROPRIETARY TO MOLEX INCORPORATED AND SHOULD NOT BE USED WITHOUT WRITTEN PERMISSION

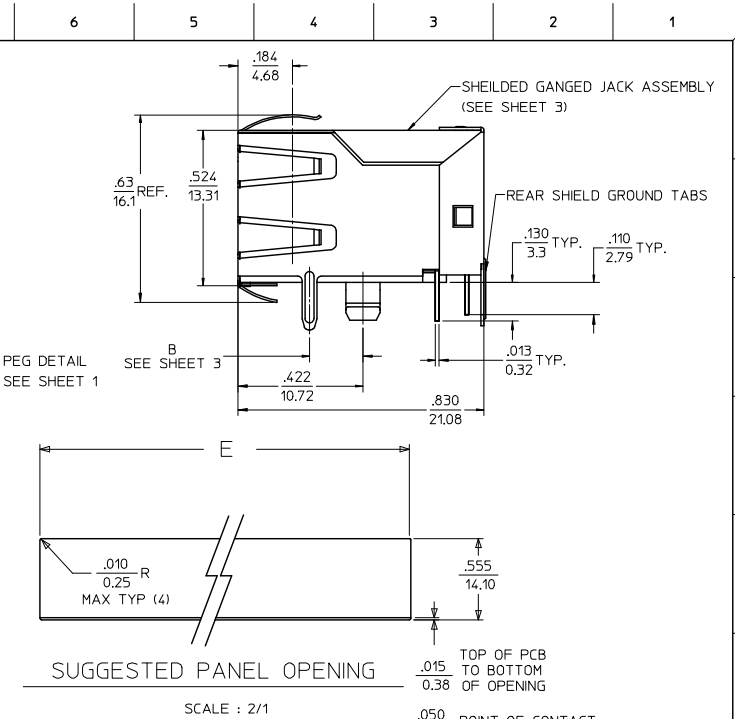
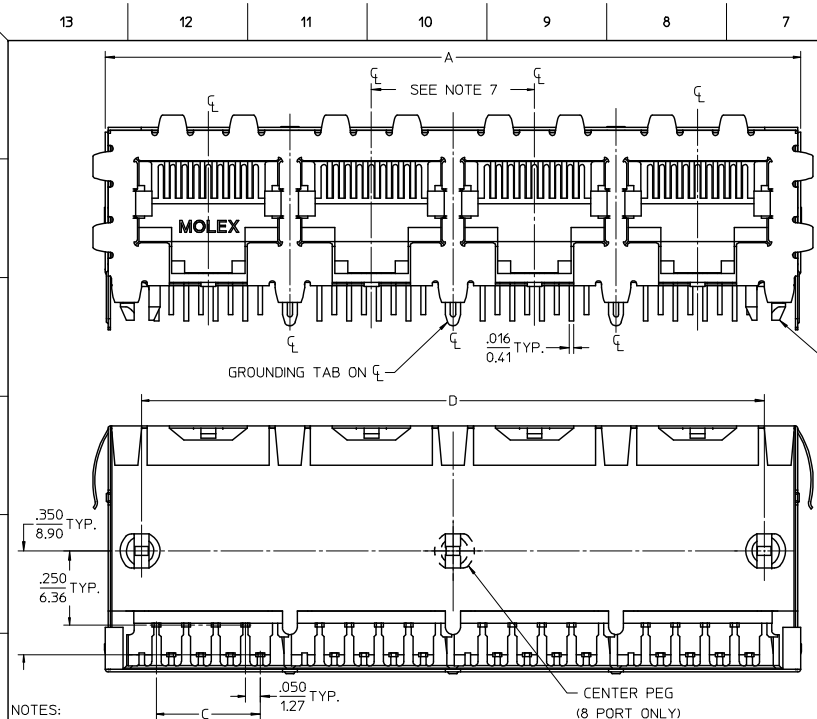

- NOTES:
- MATERIAL:
    - HOUSING: GLASS FILLED NYLON, UL94V-0, COLOR: BLACK
    - INSULATOR: GLASS FILLED NYLON, UL94V-0, COLOR: BLACK
    - TERMINALS: PHOSPHOR BRONZE: .012/ 0.30 THICK
    - SHIELD: BRASS, FRONT .007/ 0.18 THICK, REAR .010/ 0.25 THICK
  - FINISH:
    - TERMINALS:
      - SELECT GOLD IN CONTACT AREA: 50 MICROINCHES/ 127 MICROMETERS MIN.,
      - SELECT TIN IN PC TAIL AREA: 100 MICROINCHES/ 2.54 MICROMETERS MIN.,
      - WITH OVERALL NICKEL UNDERPLATE: 50 MICROINCHES/ 1.27 MICROMETERS MIN.
    - SHIELD:
      - 100 MICROINCHES/ 2.54 MICROMETERS NICKEL OVER 50 MICROINCHES/ 1.27 MICROMETERS COPPER UNDERPLATE. PCB GROUND TABS DIPPED IN TIN
      - THE PRIMARY SHIPPING CARTON WILL BE LABELED "COMPLIANT TO RoHS DIRECTIVE 2002/95/EC AND ELV ANNEX II OF DIRECTIVE 2000/53/EC". CARTONS WITHOUT THIS LABEL MAY CONTAIN PRODUCT WITH TIN-LEAD IN THE PC TAIL AND/OR SHIELD.
  - PRODUCT SPECIFICATION AND PROCESSING PARAMETERS: PS-43223-001.
  - PACKAGING SPECIFICATION:
    - SHIELDED CONNECTOR ASSEMBLIES PACKAGED IN TRAYS PER MOLEX PACKAGING SPECIFICATION PK-44150-004.
  - SEE SHEETS 4-6 FOR P.C. BOARD LAYOUTS.
  - REAR SHIELD IS AVAILABLE WITH (1) CENTERED GROUND TAB ON 4 & 8 PORT VERSIONS.
  - 8 CIRCUIT JACKS CENTERLINE TO CENTERLINE SPACING IS .550/ 13.97.
  - ALL UNTOLERANCED DIMENSIONS ARE SHOWN FOR REFERENCE ONLY.
  - THIS PART CONFORMS TO CLASS B REQUIREMENTS OF COSMETIC SPECIFICATION PS-45499-002.

HOUSING SIZE	CIRCUIT SIZE	NO. OF PORTS	DIM. A	DIM. C	DIM. D	DIM. E
8	8	2	1.224 (31.09)	.350 (8.89)	1.000 (25.40)	1.255 (31.88)
8	8	4	2.324 (59.03)	.350 (8.89)	2.100 (53.34)	2.355 (59.82)
8	8	6	3.424 (86.97)	.350 (8.89)	3.200 (81.28)	3.455 (87.76)
8	8	8	4.524 (114.91)	.350 (8.89)	4.300 (109.22)	4.555 (115.97)
8	2	8	4.524 (114.91)	.050 (1.27)	4.300 (109.22)	4.555 (115.97)

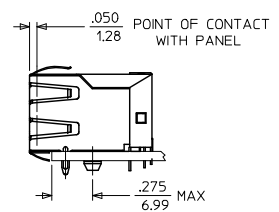

4 PORT 8 LOADED  
8 JACK SHOWN

SEE SHEET 1 EC NO. UCP2009-0477 DRWN:JBELL 2008/09/11 CHKD:JBELL 2008/09/11 APPR:SMITH 2008/09/11 K1	QUALITY SYMBOLS	GENERAL TOLERANCES (UNLESS SPECIFIED)	DIMENSION STYLE IN/MM	SCALE 4:1	DESIGN UNITS INCH	THIRD ANGLE PROJECTION	
	$\nabla=0$ $\nabla=0$	4 PLACES ±--- ±--- 3 PLACES ±--- ±.015 2 PLACES ±0.38 ±--- 1 PLACE ±--- ±--- ANGULAR ±1/2°	DRAWN BY JTR DATE 1993/10/18 CHECKED BY JTR DATE 1993/10/18 APPROVED BY RAS DATE 1993/10/18	TITLE	LOW PROFILE GANGED, RIGHT ANGLE MODULAR JACK ASSEMBLY		
	DRAFT WHERE APPLICABLE MUST REMAIN WITHIN DIMENSIONS	SEE SHTS 3	MATERIAL NO.	MOLEX INCORPORATED SDA-43223			
			SIZE C	THIS DRAWING CONTAINS INFORMATION THAT IS PROPRIETARY TO MOLEX INCORPORATED AND SHOULD NOT BE USED WITHOUT WRITTEN PERMISSION			

13 12 11 10 9 8 7 6 5 4 3 2 1

FLUSH MOUNT (UNSHIELDED)

ASSEMBLY NUMBER	CONNECTOR SIZE	NUMBER OF CIRCUITS	NUMBER OF PORTS	PACKAGING STYLE	PACKAGING SPECIFICATION
43223-6001	6	6	2	TRAY	PK-43249-004
43223-6004	6	6	3	↑	↑
43223-6007	6	6	4	↑	↑
43223-6010	6	6	5	↑	↑
43223-6013	6	6	6	↑	↑
43223-6019	6	6	8	↑	↑
43223-6022	6	4	2	↑	↑
43223-6025	6	4	3	↑	↑
43223-6028	6	4	4	↑	↑
43223-6031	6	4	5	↑	↑
43223-6034	6	4	6	↑	↑
43223-6040	6	4	8	↑	↑
43223-6043	6	2	2	↑	↑
43223-6046	6	2	3	↑	↑
43223-6049	6	2	4	↑	↑
43223-6052	6	2	5	↑	↑
43223-6055	6	2	6	↑	↑
43223-6058	6	2	8	TRAY	PK-43249-004

FLANGELESS (UNSHIELDED)

ASSEMBLY NUMBER	CONNECTOR SIZE	NUMBER OF CIRCUITS	NUMBER OF PORTS	PACKAGING STYLE	PACKAGING SPECIFICATION
43223-6101	6	6	2	TRAY	PK-43249-004
43223-6104	6	6	3	↑	↑
43223-6107	6	6	4	↑	↑
43223-6110	6	6	5	↑	↑
43223-6113	6	6	6	↑	↑
43223-6119	6	6	8	↑	↑
43223-6122	6	4	2	↑	↑
43223-6125	6	4	3	↑	↑
43223-6128	6	4	4	↑	↑
43223-6131	6	4	5	↑	↑
43223-6134	6	4	6	↑	↑
43223-6140	6	4	8	↑	↑
43223-6143	6	2	2	↑	↑
43223-6146	6	2	3	↑	↑
43223-6149	6	2	4	↑	↑
43223-6152	6	2	5	↑	↑
43223-6155	6	2	6	↑	↑
43223-6158	6	2	8	TRAY	PK-43249-004

43223-8001	8	10	2	TRAY	PK-43249-004
43223-8004	8	10	3	↑	↑
43223-8007	8	10	4	↑	↑
43223-8010	8	10	5	↑	↑
43223-8013	8	10	6	↑	↑
43223-8019	8	10	8	↑	↑
43223-8022	8	8	2	↑	↑
43223-8025	8	8	3	↑	↑
43223-8028	8	8	4	↑	↑
43223-8031	8	8	5	↑	↑
43223-8034	8	8	6	↑	↑
43223-8040	8	8	8	↑	↑
43223-8041	8	4	5	↓	↓
43223-8042	8	6	3	TRAY	PK-43249-004

43223-8101	8	10	2	TRAY	PK-43249-004
43223-8104	8	10	3	↑	↑
43223-8107	8	10	4	↑	↑
43223-8110	8	10	5	↑	↑
43223-8113	8	10	6	↑	↑
43223-8119	8	10	8	↑	↑
43223-8122	8	8	2	↑	↑
43223-8131	8	8	3	↑	↑
43223-8140	8	8	4	↑	↑
43223-8149	8	8	5	↑	↑
43223-8158	8	8	6	↓	↓
43223-8176	8	8	8	TRAY	PK-43249-004

43223-8191	8	6	2	TUBE	PK-43249-005
43223-8192	8	4	4	TUBE	PK-43249-005
43223-8193	8	4	3	TUBE	PK-43249-005
43223-8195	8	8	2	TUBE	PK-43249-005
43223-8196	8	8	3	TUBE	PK-43249-005
43223-8197	8	8	4	TUBE	PK-43249-005

FLANGELESS (SHIELDED)

ASSEMBLY NUMBER	DIMENSION "B"	CONNECTOR SIZE	NUMBER OF CIRCUITS	NUMBER OF PORTS	NUMBER OF REAR SHIELD GROUND TABS	PACKAGING STYLE	PACKAGING SPECIFICATION
43223-8128	.180	8	8	2	1	TRAY	PK-44150-004
43223-8146	.180	8	8	4	3	↑	↑
43223-8164	.180	8	8	6	5	↑	↑
43223-8182	.180	8	8	8	7	↑	↑
43223-8185	.180	8	8	8	1	↑	↑
43223-8188	.180	8	8	4	1	↓	↓
43223-8194	.180	8	2	8	7	TRAY	PK-44150-004

43223-8301	.145	8	8	2	1	TRAY	PK-44150-004
43223-8302	.145	8	8	4	3	↑	↑
43223-8303	.145	8	8	6	5	↑	↑
43223-8304	.145	8	8	8	7	↑	↑
43223-8305	.145	8	8	8	1	↑	↑
43223-8306	.145	8	8	4	1	↓	↓
43223-8307	.145	8	2	8	7	TRAY	PK-44150-004

SNAP FIT PEG VERSIONS

SEE SHEET 1 EC NO: UCP2009-0477 DRWN: J.BELL 2008/09/11 CHKD: J.BELL 2008/09/11 APPR: E.SMITH 2008/09/11 K1	QUALITY SYMBOLS ▽=0 ▽=0	GENERAL TOLERANCES (UNLESS SPECIFIED) mm INCH 4 PLACES ±.005 ±.002 3 PLACES ±.005 ±.015 2 PLACES ±0.38 ±.005 1 PLACE ±.005 ±.005 ANGULAR ±1/2°	DIMENSION STYLE IN/MM DRAWN BY DATE JTR 1993/10/18 CHECKED BY DATE JTR 1993/10/18 APPROVED BY DATE RAS 1993/10/18	SCALE 2:1 DESIGN UNITS INCH THIRD ANGLE PROJECTION	TITLE LOW PROFILE GANGED, RIGHT ANGLE MODULAR JACK ASSEMBLY
		DRAFT WHERE APPLICABLE MUST REMAIN WITHIN DIMENSIONS	MATERIAL NO. SEE CHART DOCUMENT NO. SDA-43223	MOLEX INCORPORATED	SHEET NO. 3 OF 6
		THIS DRAWING CONTAINS INFORMATION THAT IS PROPRIETARY TO MOLEX INCORPORATED AND SHOULD NOT BE USED WITHOUT WRITTEN PERMISSION			
		THIS DRAWING CONTAINS INFORMATION THAT IS PROPRIETARY TO MOLEX INCORPORATED AND SHOULD NOT BE USED WITHOUT WRITTEN PERMISSION			

13 12 11 10 9 8 7 6 5 4 3 2 1

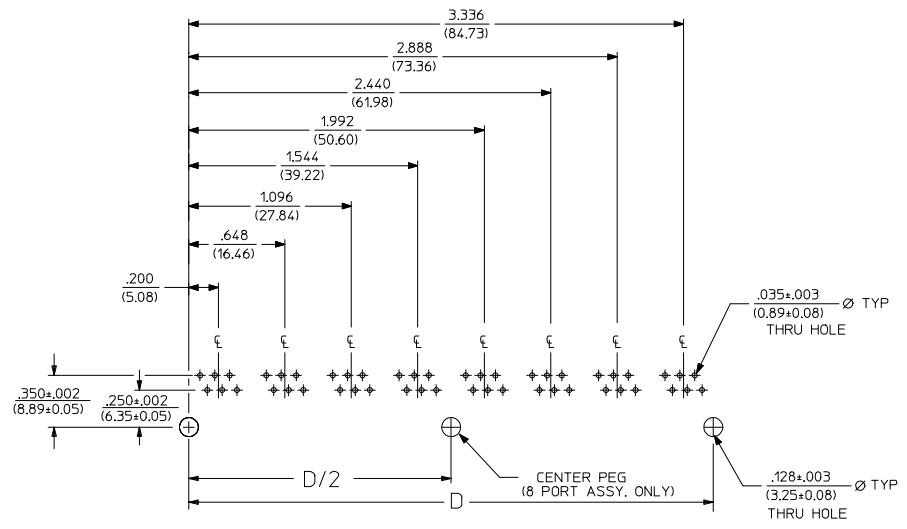
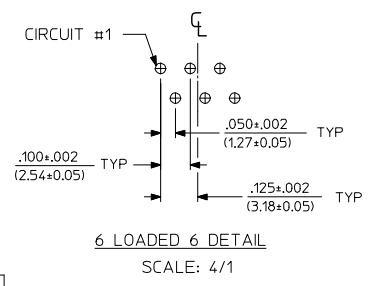
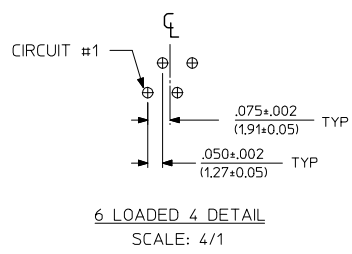
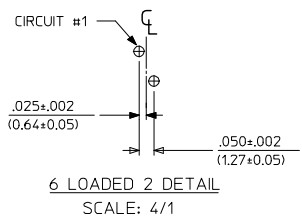

NOTES:  
1. RECOMMENDED PCB THICKNESS .062±.005/(1.57±0.13)

NUMBER OF PORTS	DIM. D
2	.848 (21.54)
3	1.296 (32.92)
4	1.744 (44.30)
5	2.192 (55.68)
6	2.640 (67.06)
8	3.536 (89.81)

SEE SHEET 1 EC NO. UCP2009-0477 DRWN:JBELL 2008/09/05 CHKD:JBELL 2008/09/11 APPR:PSMITH 2008/09/11 K1	QUALITY SYMBOLS ▽=0 ▽=0	GENERAL TOLERANCES (UNLESS SPECIFIED) mm INCH		DIMENSION STYLE IN/MM		SCALE 2:1	DESIGN UNITS INCH	THIRD ANGLE PROJECTION			
		4 PLACES ±--- ±---	3 PLACES ±--- ±.015	2 PLACES ±0.38 ±---	1 PLACE ±--- ±---	ANGULAR ±1/2°	DRAWN BY JTR DATE 1993/10/18	TITLE LOW PROFILE GANGED, RIGHT ANGLE MODULAR JACK ASSEMBLY			
		DRAFT WHERE APPLICABLE MUST REMAIN WITHIN DIMENSIONS			SEE SHT 3	MATERIAL NO. RAS		APPROVED BY RAS DATE 1993/10/18	MOLEX INCORPORATED		
					SIZE C	THIS DRAWING CONTAINS INFORMATION THAT IS PROPRIETARY TO MOLEX INCORPORATED AND SHOULD NOT BE USED WITHOUT WRITTEN PERMISSION		DOCUMENT NO. SDA-43223	SHEET NO. 4 OF 6		

12 11 10 9 8 7 6 5 4 3 2 1

13 12 11 10 9 8 7 6 5 4 3 2 1

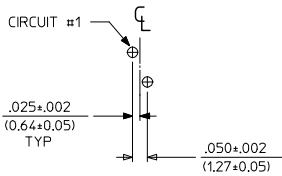

8 LOADED 2 DETAIL  
SCALE: 4/1

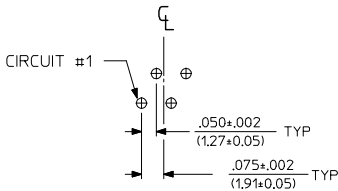

8 LOADED 4 DETAIL  
SCALE: 4/1

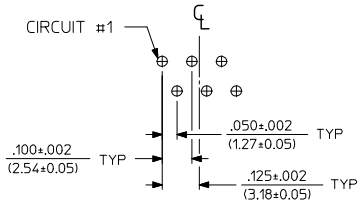

8 LOADED 6 DETAIL  
SCALE: 4/1

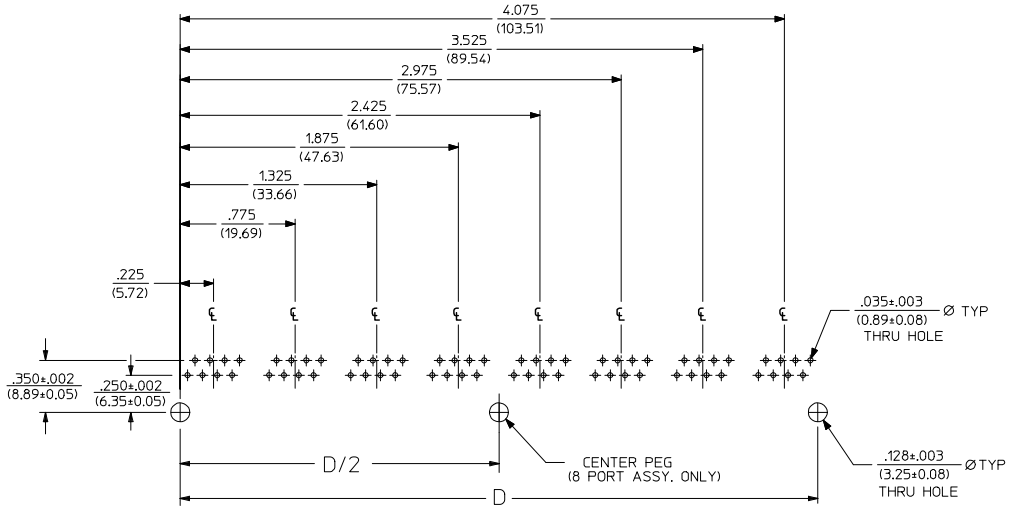

SUGGESTED P.C. BOARD LAYOUT  
COMPONENT SIDE OF BOARD  
8 PORT, 8 LOADED 8  
(SNAP-FIT VERSIONS)

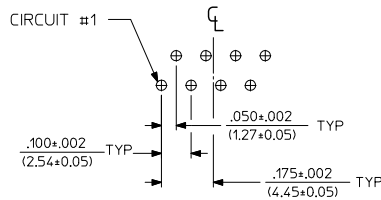

8 LOADED 8 DETAIL  
SCALE: 4/1

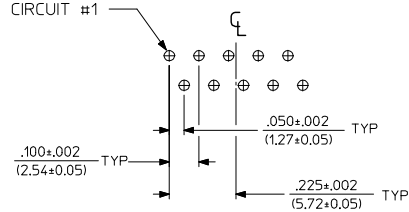

8 LOADED 10 DETAIL  
SCALE: 4/1

NOTES:  
1. RECOMMENDED PCB THICKNESS: .062±.005/(1.57±0.13)

NUMBER OF PORTS	DIM. D
2	1.000 (25.40)
3	1.550 (39.37)
4	2.100 (53.34)
5	2.650 (67.31)
6	3.200 (81.28)
8	4.300 (109.32)

SEE SHEET 1 EC NO: UCP2009-0477 DRAWN BY: JRBELL 2008/09/11 CHKD BY: JRBELL 2008/09/11 APPR: JSMITH 2008/09/11 REV: K1	QUALITY SYMBOLS	GENERAL TOLERANCES (UNLESS SPECIFIED)	DIMENSION STYLE IN/MM	SCALE 2:1	DESIGN UNITS INCH	THIRD ANGLE PROJECTION
	▽=0 ▽=0	4 PLACES ±.005 ±.005 3 PLACES ±.010 ±.010 2 PLACES ±.030 ±.030 1 PLACE ±.005 ±.005 ANGULAR ±1/2°	DRAWN BY: JTR DATE: 1993/10/18 CHECKED BY: JTR DATE: 1993/10/18 APPROVED BY: RAS DATE: 1993/10/18	TITLE: LOW PROFILE GANGED, RIGHT ANGLE MODULAR JACK ASSEMBLY MOLEX INCORPORATED		
	DRAFT WHERE APPLICABLE MUST REMAIN WITHIN DIMENSIONS	SEE SHT 3	MATERIAL NO. SDA-43223 DOCUMENT NO. 5 OF 6			
	THIS DRAWING CONTAINS INFORMATION THAT IS PROPRIETARY TO MOLEX INCORPORATED AND SHOULD NOT BE USED WITHOUT WRITTEN PERMISSION					

12 11 10 9 8 7 6 5 4 3 2 1

13 12 11 10 9 8 7 6 5 4 3 2 1

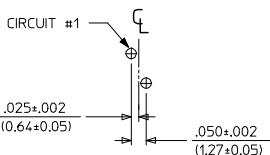

8 LOADED 2 DETAIL  
SCALE: 4/1

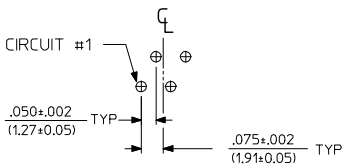

8 LOADED 4 DETAIL  
SCALE: 4/1

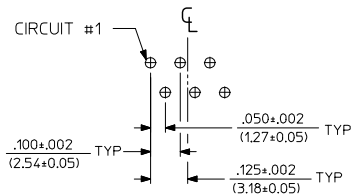

8 LOADED 6 DETAIL  
SCALE: 4/1

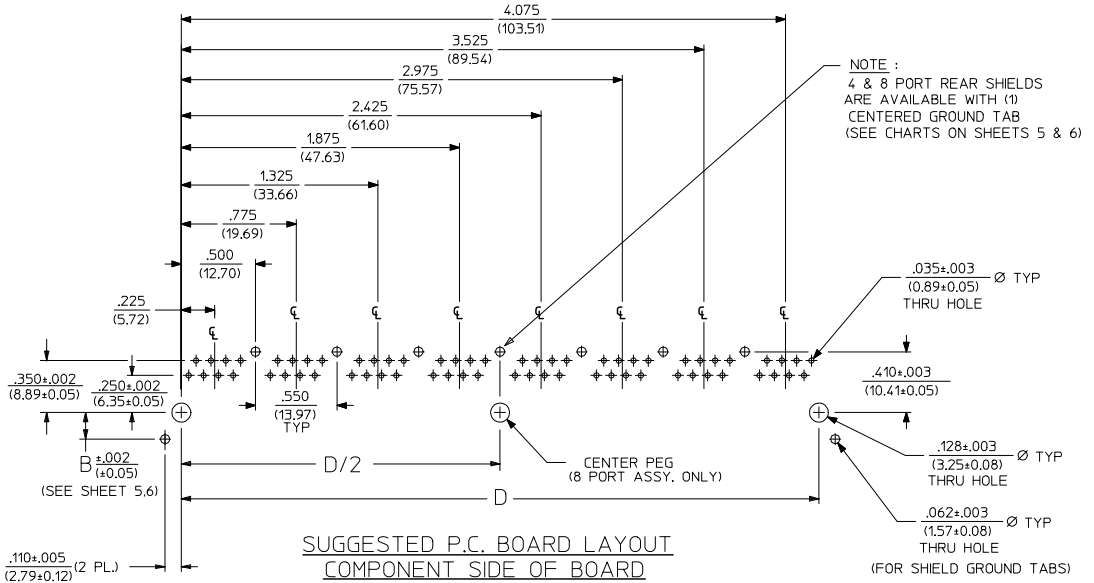

NOTE:  
4 & 8 PORT REAR SHIELDS  
ARE AVAILABLE WITH (1)  
CENTERED GROUND TAB  
(SEE CHARTS ON SHEETS 5 & 6)

SUGGESTED P.C. BOARD LAYOUT  
COMPONENT SIDE OF BOARD  
8 PORT, 8 LOADED 8  
(SHIELDED) LAYOUT SHOWN  
(SNAP-FIT VERSIONS)

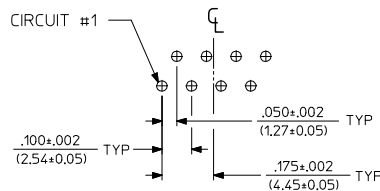

8 LOADED 8 DETAIL  
SCALE: 4/1

NOTES:  
1. RECOMMENDED POB THICKNESS: .062±.005/(1.57±0.13)

NUMBER OF PORTS	DIM. D
2	1.000 (25.40)
4	2.100 (53.34)
6	3.200 (81.28)
8	4.300 (109.32)

SEE SHEET 1 EC NO. UCP2009-0477 DRWN: JABELL 2008/09/05 CHKD: JABELL 2008/09/11 APPR: SMITH 2008/09/11 K1	QUALITY SYMBOLS	GENERAL TOLERANCES (UNLESS SPECIFIED)	DIMENSION STYLE IN/MM	SCALE 2:1	DESIGN UNITS INCH	THIRD ANGLE PROJECTION
	▽=0 ▽=0	4 PLACES ±--- ±--- 3 PLACES ±--- ±.015 2 PLACES ±0.38 ±--- 1 PLACE ±--- ±--- ANGULAR ±1/2°	DRAWN BY JTR DATE 1993/10/18 CHECKED BY JTR DATE 1993/10/18 APPROVED BY RAS DATE 1993/10/18	TITLE LOW PROFILE GANGED, RIGHT ANGLE MODULAR JACK ASSEMBLY		
	DRAFT WHERE APPLICABLE MUST REMAIN WITHIN DIMENSIONS	SEE SHT 3	MATERIAL NO. SDA-43223 DOCUMENT NO. MOLEX INCORPORATED			
		SIZE C	THIS DRAWING CONTAINS INFORMATION THAT IS PROPRIETARY TO MOLEX INCORPORATED AND SHOULD NOT BE USED WITHOUT WRITTEN PERMISSION			

12 11 10 9 8 7 6 5 4 3 2 1