

DATE	REV	ECN	APP'D. BY
02-24-04	A0	6344	-
01-27-06	A1	7468	JM
2-6-09	A2	8653	TRM

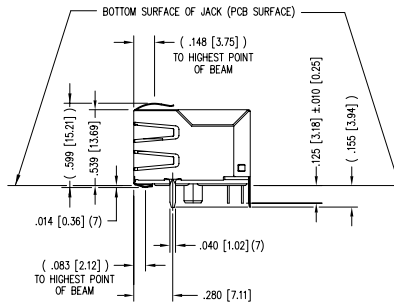
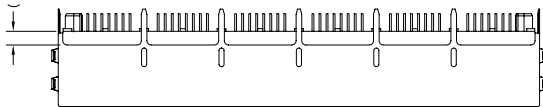
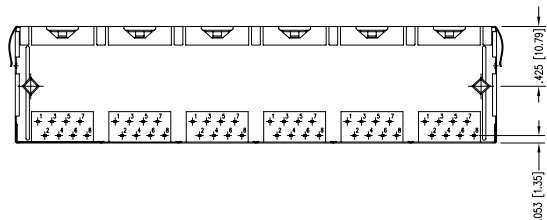
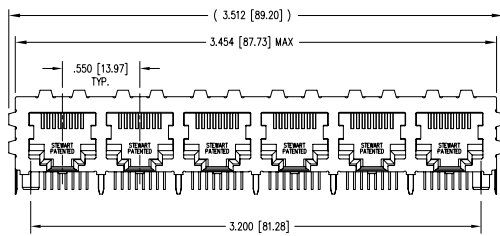
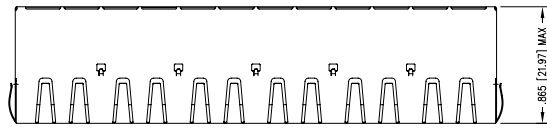

NOTES:

- CONNECTOR MATERIALS:
HOUSING: THERMOPLASTIC UL94 V-0
CONTACTS/SHIELD: COPPER ALLOY
SHIELD PLATING: NICKEL
CONTACT PLATING: SELECTIVE GOLD IN CONTACT AREA
SEE CHART FOR PART NUMBER
- FOR PRODUCT SPECIFICATION SEE PRO22-01.
- DIMENSIONS AND TOLERANCES COMPLY WITH FCC/CFR 47, PART 68.
- THE SUGGESTED PANEL OPENING IS INTENDED TO GIVE USER THE ABILITY TO HAVE REASONABLE JACK/PANEL CLEARANCES, YET MAINTAIN GROUNDING CAPABILITY. THESE VARIABLES CAN BE ADJUSTED IN EITHER DIRECTION BUT MAY CARRY SOME CONSEQUENCES IN THE FORM OF LOWER MATING FORCES OR TIGHTER ASSEMBLY TOLERANCES.

30 MICRO-INCHES [0.76um]	SS-668806S-A-PG4-AC
CONTACT PLATING IN MATING AREA	PART NUMBER

THIRD ANGLE PROJECTION

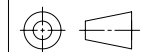

DO NOT SCALE DRAWING
DRAWING IS SUBJECT TO CHANGE WITHOUT NOTICE
DIMENSIONS: INCHES [METRIC]
UNLESS OTHERWISE SPECIFIED
TOLERANCES ARE ±.005 [0.13]
ANGLES ARE ± 1°

SHEET NO. 1 OF 2



Bel Stewart Connector

11118 Susquehanna Trail South
Glen Rock, PA 17327-9199
(717) 235-7512 Fax: (717) 235-7954 <http://www.stewartconnector.com>

TITLE: 6 PORT HARMONICA JACK PAC, EMI-RFI ENHANCED SHIELD ESD GROUNDED

THIS DRAWING AND THE SUBJECT MATTER SHOWN THEREON ARE CONFIDENTIAL AND THE PROPRIETARY PROPERTY OF BEL STEWART CONNECTOR AND SHALL NOT BE REPRODUCED, COPIED, OR USED IN ANY MANNER WITHOUT PRIOR WRITTEN CONSENT OF BEL STEWART CONNECTOR. THE SUBJECT MATTER MAY BE PATENTED OR A PATENT MAY BE PENDING.

DRN BY: TRM	DATE: 2-26-04
APP'D BY: RGC	DATE: 2-26-04
DWG NO: CT660100	REV: A2

AutoCAD

REV. 7/5/03

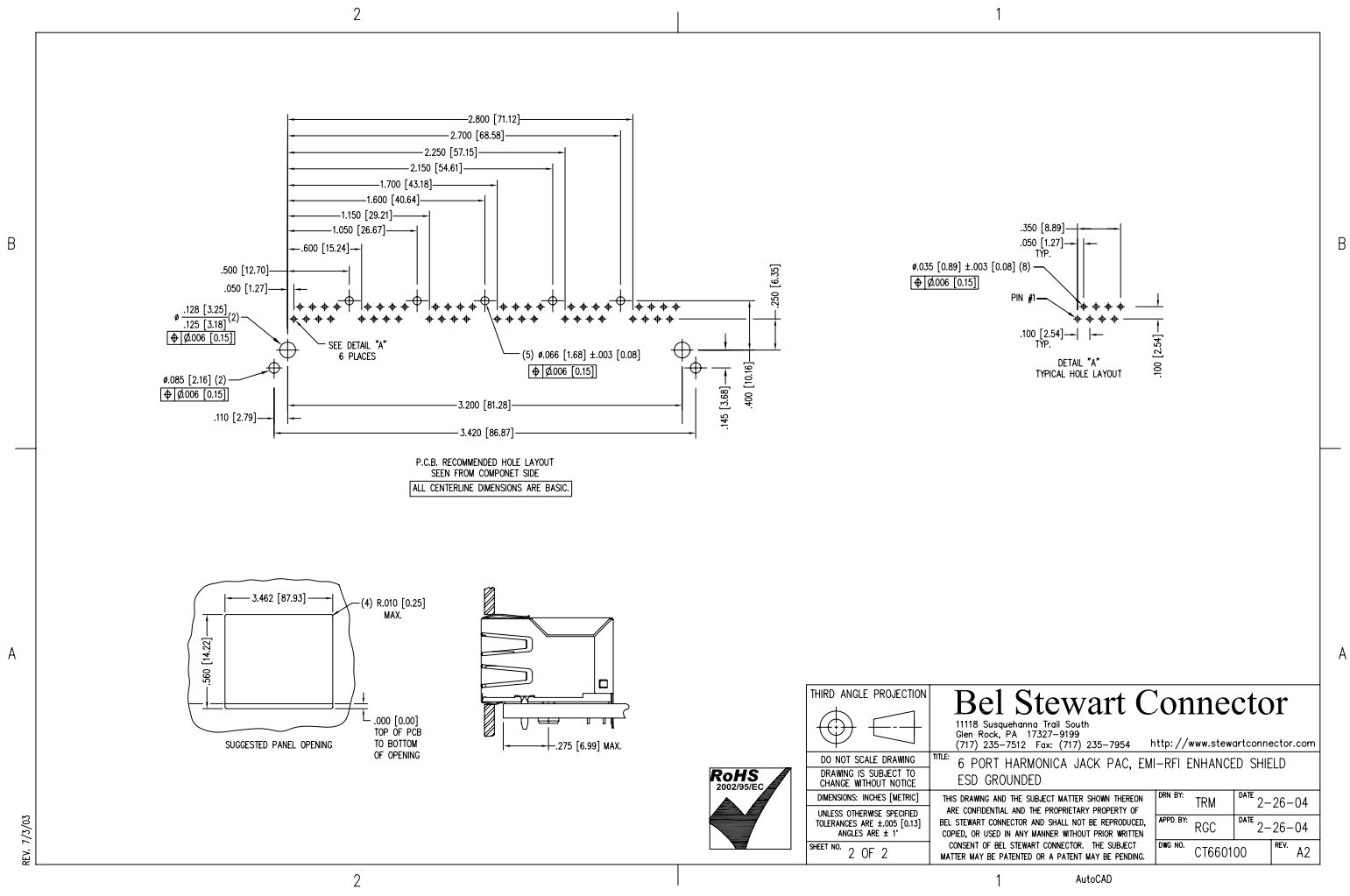

THIRD ANGLE PROJECTION

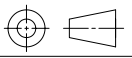

Bel Stewart Connector

11118 Susquehanna Trail South
Glen Rock, PA 17327-9199
(717) 235-7512 Fax: (717) 235-7954 <http://www.stewartconnector.com>

DO NOT SCALE DRAWING
DRAWING IS SUBJECT TO CHANGE WITHOUT NOTICE
DIMENSIONS: INCHES [METRIC]
UNLESS OTHERWISE SPECIFIED TOLERANCES ARE ±.005 [0.13] ANGLES ARE ± 1°
SHEET NO. 2 OF 2

TITLE: 6 PORT HARMONICA JACK PAC, EMI-RFI ENHANCED SHIELD ESD GROUNDED

DRN BY: TRM	DATE: 2-26-04
APPD BY: RGC	DATE: 2-26-04
DWG NO. CT660100	REV. A2



AutoCAD

REV. 7/5/03