

NOTES:

- 1) MATERIAL:  
HOUSING: GLASS FILLED NYLON, UL94V-0, COLOR: BLACK  
INSULATOR: GLASS FILLED NYLON, UL94V-0, COLOR: BLACK  
TERMINALS: PHOSPHOR BRONZE: .012/ 0.30 THICK
- 2) FINISH:  
TERMINALS:  
SELECT GOLD IN CONTACT AREA: 50 MICRONS/ 1.27 MICROMETERS MIN.  
\*SELECT TIN IN PC TAIL AREA: 100 MICRONS/ 2.54 MICROMETERS MIN.  
WITH OVERALL NICKEL UNDERPLATE: 50 MICRONS/ 1.27 MICROMETERS MIN.  
\*THE PRIMARY SHIPPING CARTON WILL BE LABELED 'COMPLIANT TO ROHS DIRECTIVE 2002/95/EC AND ELV ANNEX II OF DIRECTIVE 2000/53/EC'. CARTONS WITHOUT THIS LABEL MAY CONTAIN PRODUCT WITH TIN-LEAD IN THE PC TAIL AREA.
- 3) PRODUCT SPECIFICATION AND PROCESSING PARAMETERS: PS-43223-001.
- 4) PACKAGING SPECIFICATION:  
UNSHIELDED CONNECTOR ASSEMBLIES PACKAGED IN TRAYS PER MOLEX PACKAGING SPECIFICATION PK-43249-004.
- 5) SEE SHEETS 4-6 FOR P.C. BOARD LAYOUTS.
- 6) SEE SHEET 2 FOR THE SHIELDED JACK ASSEMBLY.
- 7) FOR 6 CIRCUIT JACKS CENTERLINE TO CENTERLINE SPACING IS .448/ 11.38, FOR 8 CIRCUIT JACKS CENTERLINE TO CENTERLINE SPACING IS .550/ 13.97.
- 8) ALL UNTOLERANCED DIMENSIONS ARE SHOWN FOR REFERENCE ONLY.
- 9) THIS PART CONFORMS TO CLASS B REQUIREMENTS OF COSMETIC SPECIFICATION PS-45499-002.

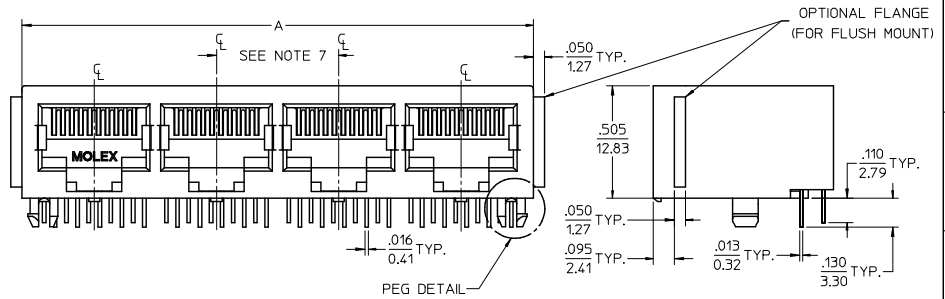

4 PORT 8 LOADED  
10 JACK SHOWN

UNSHIELDED GANGED JACK ASSEMBLY  
SEE SHEET 3

CENTER PEG  
(8 PORT ASSY. ONLY)

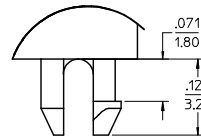

SNAP-FIT  
PEG DETAIL  
SCALE 8:1

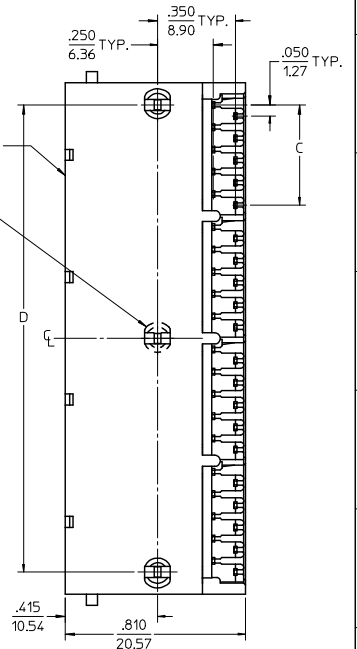

6 CIRCUIT HOUSING

CIRCUIT SIZE	NO. OF PORTS	DIM. A	DIM. C	DIM. D
6	2	.985 (25.02)	.250 (6.35)	.848 (21.54)
4	2	.985 (25.02)	.150 (3.81)	.848 (21.54)
2	2	.985 (25.02)	.050 (1.27)	.848 (21.54)
6	3	1.433 (36.40)	.250 (6.35)	1.296 (32.92)
4	3	1.433 (36.40)	.150 (3.81)	1.296 (32.92)
2	3	1.433 (36.40)	.050 (1.27)	1.296 (32.92)
6	4	1.881 (47.78)	.250 (6.35)	1.744 (44.30)
4	4	1.881 (47.78)	.150 (3.81)	1.744 (44.30)
2	4	1.881 (47.78)	.050 (1.27)	1.744 (44.30)
6	5	2.329 (59.16)	.250 (6.35)	2.192 (55.68)
4	5	2.329 (59.16)	.150 (3.81)	2.192 (55.68)
2	5	2.329 (59.16)	.050 (1.27)	2.192 (55.68)
6	6	2.777 (70.54)	.250 (6.35)	2.640 (67.06)
4	6	2.777 (70.54)	.150 (3.81)	2.640 (67.06)
2	6	2.777 (70.54)	.050 (1.27)	2.640 (67.06)
6	8	3.673 (93.29)	.250 (6.35)	3.536 (89.81)
4	8	3.673 (93.29)	.150 (3.81)	3.536 (89.81)
2	8	3.673 (93.29)	.050 (1.27)	3.536 (89.81)

8 CIRCUIT HOUSING

CIRCUIT SIZE	NO. OF PORTS	DIM. A	DIM. C	DIM. D
10	2	1.200 (30.48)	.450 (11.43)	1.000 (25.40)
8	2	1.200 (30.48)	.350 (8.89)	1.000 (25.40)
6	2	1.200 (30.48)	.250 (6.35)	1.000 (25.40)
10	3	1.750 (44.45)	.450 (11.43)	1.550 (39.37)
8	3	1.750 (44.45)	.350 (8.89)	1.550 (39.37)
6	3	1.750 (44.45)	.250 (6.35)	1.550 (39.37)
4	3	1.750 (44.45)	.150 (3.81)	1.550 (39.37)
10	4	2.300 (58.42)	.450 (11.43)	2.100 (53.34)
8	4	2.300 (58.42)	.350 (8.89)	2.100 (53.34)
4	4	2.300 (58.42)	.150 (3.81)	2.100 (53.34)
4	5	2.850 (72.39)	.150 (3.81)	2.650 (67.31)
10	5	2.850 (72.39)	.450 (11.43)	2.650 (67.31)
8	5	2.850 (72.39)	.350 (8.89)	2.650 (67.31)
10	6	3.400 (86.36)	.450 (11.43)	3.200 (81.28)
8	6	3.400 (86.36)	.350 (8.89)	3.200 (81.28)
10	8	4.500 (114.30)	.450 (11.43)	4.300 (109.22)
8	8	4.500 (114.30)	.350 (8.89)	4.300 (109.22)

ADD BLOCK TOL EC NO. LCP2009-0477 2008/09/05 DRWN:JBELL 2008/09/11 CHKD:JBELL 2008/09/11 APPR:SPMTH 2008/09/11	QUALITY SYMBOLS ▽=0 ▽=0	GENERAL TOLERANCES (UNLESS SPECIFIED)		DIMENSION STYLE IN/MM		SCALE 3:1	DESIGN UNITS INCH	THIRD ANGLE PROJECTION	
		4 PLACES ± --- ± --- 3 PLACES ± --- ± .015 2 PLACES ± 0.38 ± --- 1 PLACE ± --- ± ---	mm INCH	DRAWN BY JTR	DATE 1993/10/18	TITLE LOW PROFILE GANGED, RIGHT ANGLE MODULAR JACK ASSEMBLY			
		ANGULAR ±1/2°		CHECKED BY JTR	DATE 1993/10/18	MOLEX INCORPORATED			
		DRAFT WHERE APPLICABLE MUST REMAIN WITHIN DIMENSIONS		APPROVED BY RAS	DATE 1993/10/18	MATERIAL NO. SEE SHTS 3	DOCUMENT NO. SDA-43223	SHEET NO. 1 OF 6	

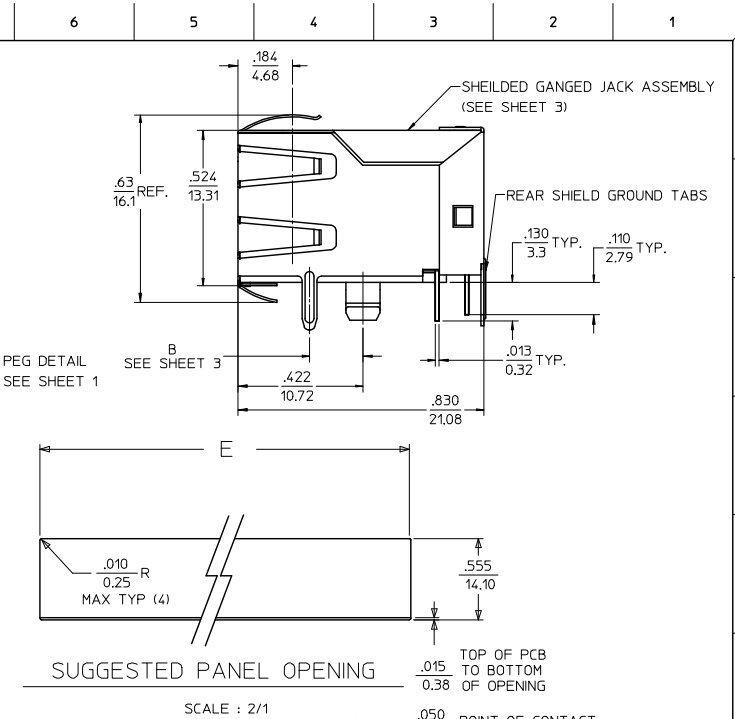
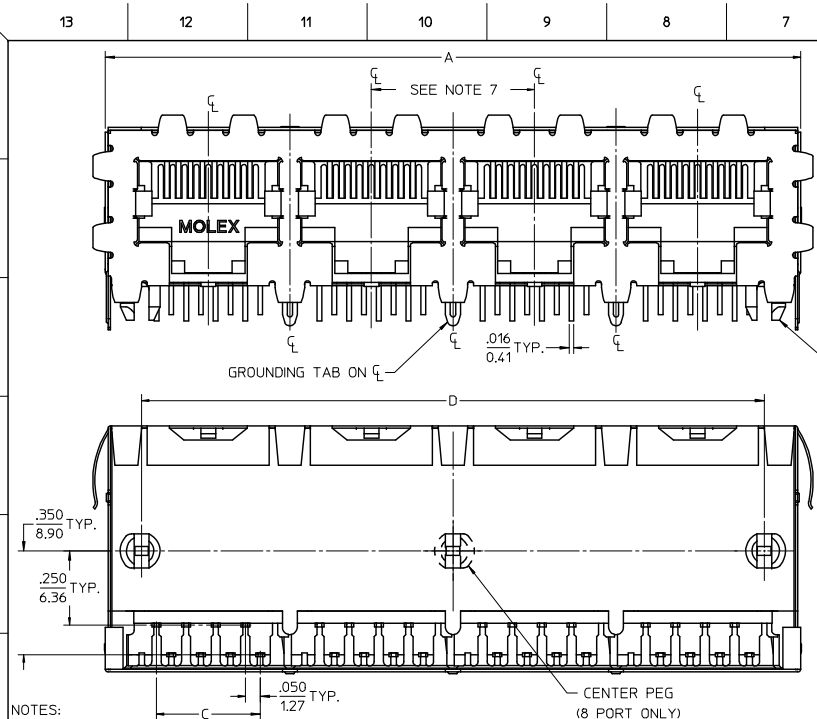

- NOTES:
- MATERIAL:
    - HOUSING: GLASS FILLED NYLON, UL94V-0, COLOR: BLACK
    - INSULATOR: GLASS FILLED NYLON, UL94V-0, COLOR: BLACK
    - TERMINALS: PHOSPHOR BRONZE: .012/ 0.30 THICK
    - SHIELD: BRASS, FRONT .007/ 0.18 THICK, REAR .010/ 0.25 THICK
  - FINISH:
    - TERMINALS:
      - SELECT GOLD IN CONTACT AREA: 50 MICROINCHES/ 127 MICROMETERS MIN.,
      - SELECT TIN IN PC TAIL AREA: 100 MICROINCHES/ 2.54 MICROMETERS MIN.,
      - WITH OVERALL NICKEL UNDERPLATE: 50 MICROINCHES/ 1.27 MICROMETERS MIN.
    - SHIELD:
      - 100 MICROINCHES/ 2.54 MICROMETERS NICKEL OVER 50 MICROINCHES/ 1.27 MICROMETERS COPPER UNDERPLATE. PCB GROUND TABS DIPPED IN TIN
      - THE PRIMARY SHIPPING CARTON WILL BE LABELED "COMPLIANT TO RoHS DIRECTIVE 2002/95/EC AND ELV ANNEX II OF DIRECTIVE 2000/53/EC". CARTONS WITHOUT THIS LABEL MAY CONTAIN PRODUCT WITH TIN-LEAD IN THE PC TAIL AND/OR SHIELD.
  - PRODUCT SPECIFICATION AND PROCESSING PARAMETERS: PS-43223-001.
  - PACKAGING SPECIFICATION:
    - SHIELDED CONNECTOR ASSEMBLIES PACKAGED IN TRAYS PER MOLEX PACKAGING SPECIFICATION PK-44150-004.
  - SEE SHEETS 4-6 FOR P.C. BOARD LAYOUTS.
  - REAR SHIELD IS AVAILABLE WITH (1) CENTERED GROUND TAB ON 4 & 8 PORT VERSIONS.
  - 8 CIRCUIT JACKS CENTERLINE TO CENTERLINE SPACING IS .550/ 13.97.
  - ALL UNTOLERANCED DIMENSIONS ARE SHOWN FOR REFERENCE ONLY.
  - THIS PART CONFORMS TO CLASS B REQUIREMENTS OF COSMETIC SPECIFICATION PS-45499-002.

HOUSING SIZE	CIRCUIT SIZE	NO. OF PORTS	DIM. A	DIM. C	DIM. D	DIM. E
8	8	2	1.224 (31.09)	.350 (8.89)	1.000 (25.40)	1.255 (31.88)
8	8	4	2.324 (59.03)	.350 (8.89)	2.100 (53.34)	2.355 (59.82)
8	8	6	3.424 (86.97)	.350 (8.89)	3.200 (81.28)	3.455 (87.76)
8	8	8	4.524 (114.91)	.350 (8.89)	4.300 (109.22)	4.555 (115.97)
8	2	8	4.524 (114.91)	.050 (1.27)	4.300 (109.22)	4.555 (115.97)

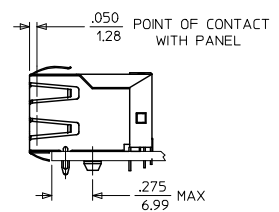

4 PORT 8 LOADED  
8 JACK SHOWN

SEE SHEET 1 EC NO. UCP2009-0477 DRWN:JBELL 2008/09/11 CHKD:JBELL 2008/09/11 APPR:SMITH 2008/09/11 K1	QUALITY SYMBOLS	GENERAL TOLERANCES (UNLESS SPECIFIED)	DIMENSION STYLE IN/MM	SCALE 4:1	DESIGN UNITS INCH	THIRD ANGLE PROJECTION
	$\nabla=0$ $\nabla=0$	4 PLACES ± .015 3 PLACES ± .015 2 PLACES ± 0.38 1 PLACE ± .015 ANGULAR ± 1/2°	mm INCH	DRAWN BY JTR DATE 1993/10/18 CHECKED BY JTR DATE 1993/10/18 APPROVED BY RAS DATE 1993/10/18	TITLE	LOW PROFILE GANGED, RIGHT ANGLE MODULAR JACK ASSEMBLY
	DRAFT WHERE APPLICABLE MUST REMAIN WITHIN DIMENSIONS	SEE SHTS 3	MATERIAL NO.	DOCUMENT NO.	MOLEX INCORPORATED	
					SDA-43223	SHEET NO. 2 OF 6

13 12 11 10 9 8 7 6 5 4 3 2 1

FLUSH MOUNT (UNSHIELDED)

ASSEMBLY NUMBER	CONNECTOR SIZE	NUMBER OF CIRCUITS	NUMBER OF PORTS	PACKAGING STYLE	PACKAGING SPECIFICATION
43223-6001	6	6	2	TRAY	PK-43249-004
43223-6004	6	6	3	↑	↑
43223-6007	6	6	4	↑	↑
43223-6010	6	6	5	↑	↑
43223-6013	6	6	6	↑	↑
43223-6019	6	6	8	↑	↑
43223-6022	6	4	2	↑	↑
43223-6025	6	4	3	↑	↑
43223-6028	6	4	4	↑	↑
43223-6031	6	4	5	↑	↑
43223-6034	6	4	6	↑	↑
43223-6040	6	4	8	↑	↑
43223-6043	6	2	2	↑	↑
43223-6046	6	2	3	↑	↑
43223-6049	6	2	4	↑	↑
43223-6052	6	2	5	↑	↑
43223-6055	6	2	6	↑	↑
43223-6058	6	2	8	TRAY	PK-43249-004

FLANGELESS (UNSHIELDED)

ASSEMBLY NUMBER	CONNECTOR SIZE	NUMBER OF CIRCUITS	NUMBER OF PORTS	PACKAGING STYLE	PACKAGING SPECIFICATION
43223-6101	6	6	2	TRAY	PK-43249-004
43223-6104	6	6	3	↑	↑
43223-6107	6	6	4	↑	↑
43223-6110	6	6	5	↑	↑
43223-6113	6	6	6	↑	↑
43223-6119	6	6	8	↑	↑
43223-6122	6	4	2	↑	↑
43223-6125	6	4	3	↑	↑
43223-6128	6	4	4	↑	↑
43223-6131	6	4	5	↑	↑
43223-6134	6	4	6	↑	↑
43223-6140	6	4	8	↑	↑
43223-6143	6	2	2	↑	↑
43223-6146	6	2	3	↑	↑
43223-6149	6	2	4	↑	↑
43223-6152	6	2	5	↑	↑
43223-6155	6	2	6	↑	↑
43223-6158	6	2	8	TRAY	PK-43249-004

43223-8001	8	10	2	TRAY	PK-43249-004
43223-8004	8	10	3	↑	↑
43223-8007	8	10	4	↑	↑
43223-8010	8	10	5	↑	↑
43223-8013	8	10	6	↑	↑
43223-8019	8	10	8	↑	↑
43223-8022	8	8	2	↑	↑
43223-8025	8	8	3	↑	↑
43223-8028	8	8	4	↑	↑
43223-8031	8	8	5	↑	↑
43223-8034	8	8	6	↑	↑
43223-8040	8	8	8	↑	↑
43223-8041	8	4	5	↓	↓
43223-8042	8	6	3	TRAY	PK-43249-004

43223-8101	8	10	2	TRAY	PK-43249-004
43223-8104	8	10	3	↑	↑
43223-8107	8	10	4	↑	↑
43223-8110	8	10	5	↑	↑
43223-8113	8	10	6	↑	↑
43223-8119	8	10	8	↑	↑
43223-8122	8	8	2	↑	↑
43223-8131	8	8	3	↑	↑
43223-8140	8	8	4	↑	↑
43223-8149	8	8	5	↑	↑
43223-8158	8	8	6	↓	↓
43223-8176	8	8	8	TRAY	PK-43249-004

43223-8191	8	6	2	TUBE	PK-43249-005
43223-8192	8	4	4	TUBE	PK-43249-005
43223-8193	8	4	3	TUBE	PK-43249-005
43223-8195	8	8	2	TUBE	PK-43249-005
43223-8196	8	8	3	TUBE	PK-43249-005
43223-8197	8	8	4	TUBE	PK-43249-005

FLANGELESS (SHIELDED)

ASSEMBLY NUMBER	DIMENSION "B"	CONNECTOR SIZE	NUMBER OF CIRCUITS	NUMBER OF PORTS	NUMBER OF REAR SHIELD GROUND TABS	PACKAGING STYLE	PACKAGING SPECIFICATION
43223-8128	.180	8	8	2	1	TRAY	PK-44150-004
43223-8146	.180	8	8	4	3	↑	↑
43223-8164	.180	8	8	6	5	↑	↑
43223-8182	.180	8	8	8	7	↑	↑
43223-8185	.180	8	8	8	1	↑	↑
43223-8188	.180	8	8	4	1	↓	↓
43223-8194	.180	8	2	8	7	TRAY	PK-44150-004

43223-8301	.145	8	8	2	1	TRAY	PK-44150-004
43223-8302	.145	8	8	4	3	↑	↑
43223-8303	.145	8	8	6	5	↑	↑
43223-8304	.145	8	8	8	7	↑	↑
43223-8305	.145	8	8	8	1	↑	↑
43223-8306	.145	8	8	4	1	↓	↓
43223-8307	.145	8	2	8	7	TRAY	PK-44150-004

SNAP FIT PEG VERSIONS

SEE SHEET 1 EC NO: UCP2009-0477 DRWN: J.BELL 2008/09/11 CHKD: J.BELL 2008/09/11 APPR: E.SMITH 2008/09/11 K1	QUALITY SYMBOLS ▽=0 ▽=0	GENERAL TOLERANCES (UNLESS SPECIFIED) mm INCH 4 PLACES ±.005 ±.002 3 PLACES ±.005 ±.015 2 PLACES ±0.38 ±.005 1 PLACE ±.005 ±.005 ANGULAR ±1/2°	DIMENSION STYLE IN/MM DRAWN BY DATE JTR 1993/10/18 CHECKED BY DATE JTR 1993/10/18 APPROVED BY DATE RAS 1993/10/18	SCALE 2:1 DESIGN UNITS INCH THIRD ANGLE PROJECTION	TITLE LOW PROFILE GANGED, RIGHT ANGLE MODULAR JACK ASSEMBLY
		DRAFT WHERE APPLICABLE MUST REMAIN WITHIN DIMENSIONS	MATERIAL NO. SEE CHART DOCUMENT NO. SDA-43223	MOLEX INCORPORATED	SHEET NO. 3 OF 6
		THIS DRAWING CONTAINS INFORMATION THAT IS PROPRIETARY TO MOLEX INCORPORATED AND SHOULD NOT BE USED WITHOUT WRITTEN PERMISSION			
		SIZE C			

12 11 10 9 8 7 6 5 4 3 2 1

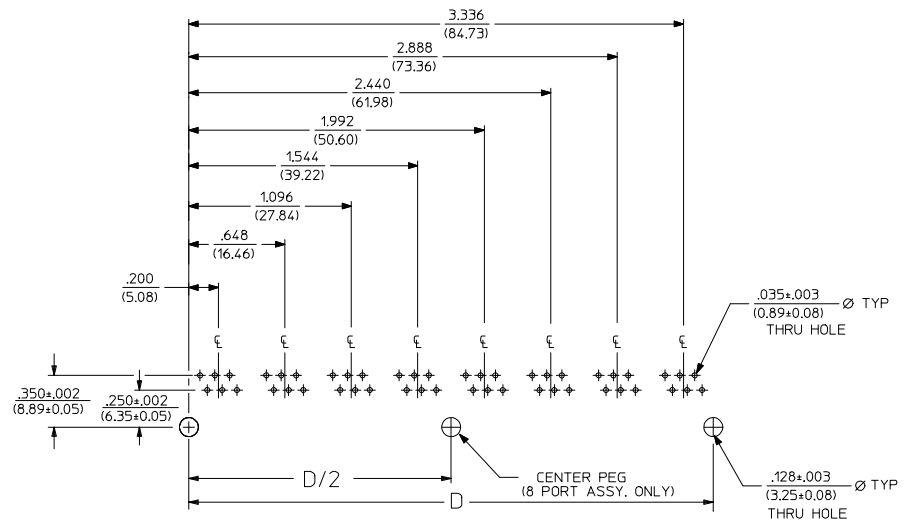
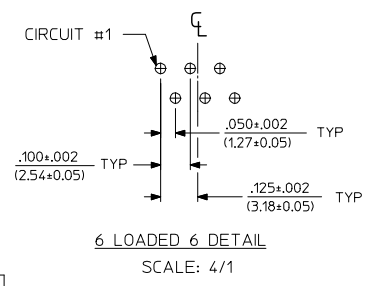
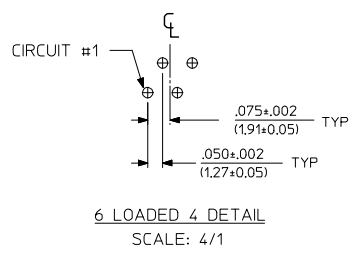
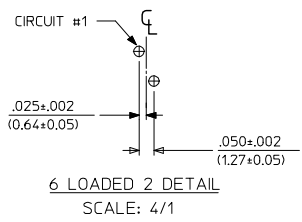

**SUGGESTED P.C. BOARD LAYOUT  
COMPONENT SIDE OF BOARD  
8 PORT, 6 LOADED 6, LAYOUT SHOWN  
(SNAP-FIT VERSIONS)**

NOTES:  
1. RECOMMENDED PCB THICKNESS .062±.005/(1.57±0.13)

NUMBER OF PORTS	DIM. D
2	.848 (21.54)
3	1.296 (32.92)
4	1.744 (44.30)
5	2.192 (55.68)
6	2.640 (67.06)
8	3.536 (89.81)

SEE SHEET 1 EC NO. UCP2009-0477 DRWN:JBELL 2008/09/05 CHKD:JBELL 2008/09/11 APPR:PSMITH 2008/09/11 K1	QUALITY SYMBOLS ▽=0 ▽=0	GENERAL TOLERANCES (UNLESS SPECIFIED) mm INCH		DIMENSION STYLE IN/MM		SCALE 2:1	DESIGN UNITS INCH	THIRD ANGLE PROJECTION		
		4 PLACES ±--- ±---	3 PLACES ±--- ±.015	2 PLACES ±0.38 ±---	1 PLACE ±--- ±---	ANGULAR ±1/2°	DRAWN BY JTR DATE 1993/10/18	TITLE LOW PROFILE GANGED, RIGHT ANGLE MODULAR JACK ASSEMBLY		
		DRAFT WHERE APPLICABLE MUST REMAIN WITHIN DIMENSIONS		SEE SHT 3		MATERIAL NO. RAS DATE 1993/10/18		MOLEX INCORPORATED		
		SIZE C		THIS DRAWING CONTAINS INFORMATION THAT IS PROPRIETARY TO MOLEX INCORPORATED AND SHOULD NOT BE USED WITHOUT WRITTEN PERMISSION		DOCUMENT NO. SDA-43223		SHEET NO. 4 OF 6		

13 12 11 10 9 8 7 6 5 4 3 2 1

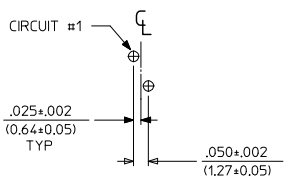

8 LOADED 2 DETAIL  
SCALE: 4/1

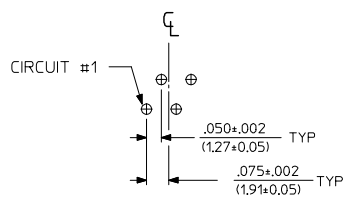

8 LOADED 4 DETAIL  
SCALE: 4/1

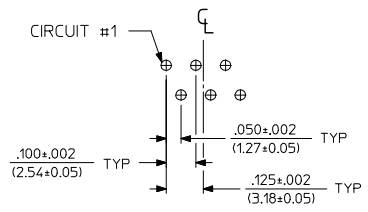

8 LOADED 6 DETAIL  
SCALE: 4/1

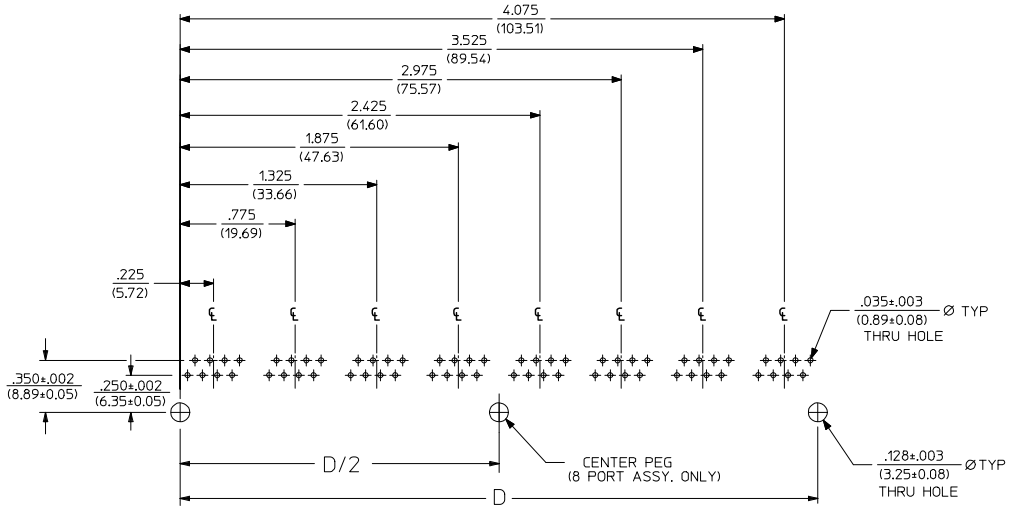

SUGGESTED P.C. BOARD LAYOUT  
COMPONENT SIDE OF BOARD  
8 PORT, 8 LOADED 8  
(SNAP-FIT VERSIONS)

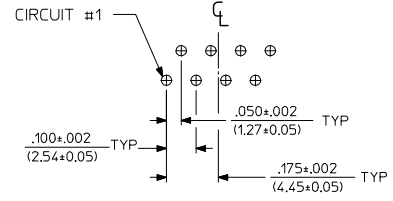

8 LOADED 8 DETAIL  
SCALE: 4/1

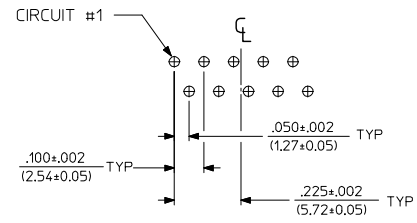

8 LOADED 10 DETAIL  
SCALE: 4/1

NOTES:  
1. RECOMMENDED PCB THICKNESS: .062±.005/(1.57±0.13)

NUMBER OF PORTS	DIM. D
2	1.000 (25.40)
3	1.550 (39.37)
4	2.100 (53.34)
5	2.650 (67.31)
6	3.200 (81.28)
8	4.300 (109.32)

SEE SHEET 1 EC NO: UCP2009-0477 DRAWN: J.BELL 2008/09/11 CHKD: J.BELL 2008/09/11 APPR: J.SMITH 2008/09/11 REV: K1	QUALITY SYMBOLS ▽=0 ▽=0	GENERAL TOLERANCES (UNLESS SPECIFIED) 4 PLACES ±.005 ±.005 3 PLACES ±.005 ±.015 2 PLACES ±.038 ±.005 1 PLACE ±.005 ±.005 ANGULAR ±1/2°	DIMENSION STYLE IN/MM DRAWN BY: JTR DATE: 1993/10/18 CHECKED BY: JTR DATE: 1993/10/18 APPROVED BY: RAS DATE: 1993/10/18	SCALE: 2:1 DESIGN UNITS: INCH THIRD ANGLE PROJECTION
	TITLE: LOW PROFILE GANGED, RIGHT ANGLE MODULAR JACK ASSEMBLY			
	MATERIAL NO.: SEE SHT 3 DOCUMENT NO.: SDA-43223 SHEET NO.: 5 OF 6			
	DRAFT WHERE APPLICABLE MUST REMAIN WITHIN DIMENSIONS THIS DRAWING CONTAINS INFORMATION THAT IS PROPRIETARY TO MOLEX INCORPORATED AND SHOULD NOT BE USED WITHOUT WRITTEN PERMISSION			

12 11 10 9 8 7 6 5 4 3 2 1

13 12 11 10 9 8 7 6 5 4 3 2 1

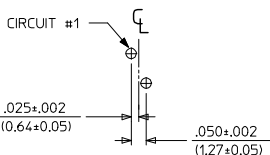

8 LOADED 2 DETAIL  
SCALE: 4/1

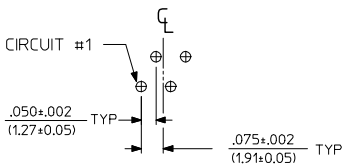

8 LOADED 4 DETAIL  
SCALE: 4/1

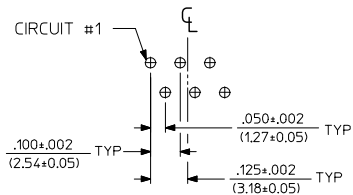

8 LOADED 6 DETAIL  
SCALE: 4/1

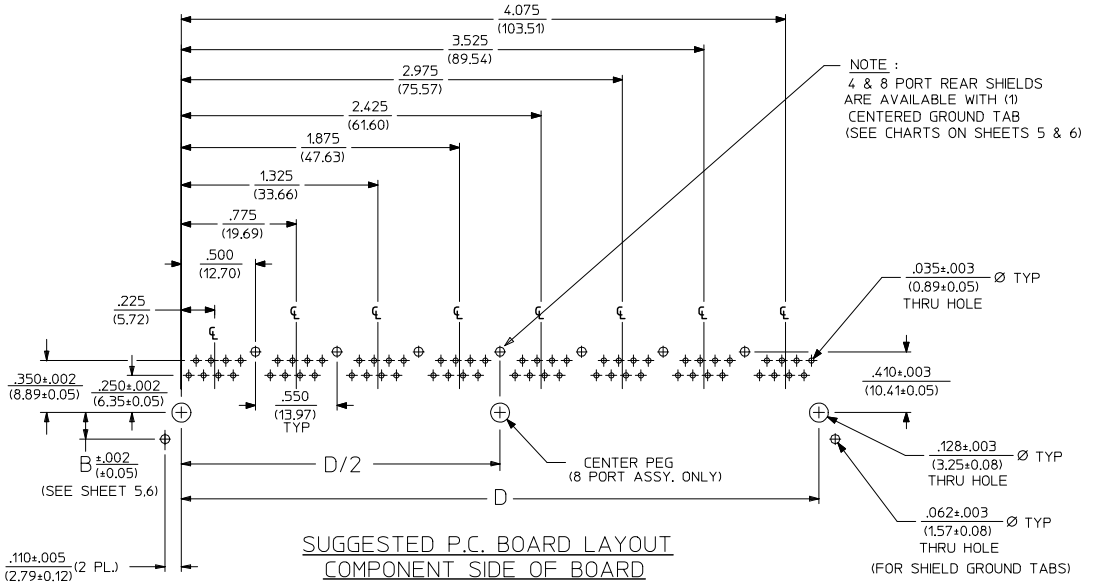

NOTE:  
4 & 8 PORT REAR SHIELDS  
ARE AVAILABLE WITH (1)  
CENTERED GROUND TAB  
(SEE CHARTS ON SHEETS 5 & 6)

SUGGESTED P.C. BOARD LAYOUT  
COMPONENT SIDE OF BOARD  
8 PORT, 8 LOADED 8  
(SHIELDED) LAYOUT SHOWN  
(SNAP-FIT VERSIONS)

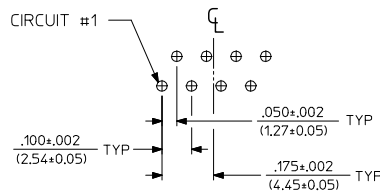

8 LOADED 8 DETAIL  
SCALE: 4/1

NOTES:  
1. RECOMMENDED POB THICKNESS: .062±.005/(1.57±0.13)

NUMBER OF PORTS	DIM. D
2	1.000 (25.40)
4	2.100 (53.34)
6	3.200 (81.28)
8	4.300 (109.32)

SEE SHEET 1 EC NO. UCP2009-0477 DRWN: J.BELL 2008/09/05 CHKD: J.BELL 2008/09/11 APPR: S.SMITH 2008/09/11 K1	QUALITY SYMBOLS ▽=0 ▽=0	GENERAL TOLERANCES (UNLESS SPECIFIED)		DIMENSION STYLE IN/MM		SCALE 2:1	DESIGN UNITS INCH	THIRD ANGLE PROJECTION		
		4 PLACES ±.015	3 PLACES ±.015	2 PLACES ±.038	1 PLACE ±.075	DRAWN BY JTR	DATE 1993/10/18	TITLE LOW PROFILE GANGED, RIGHT ANGLE MODULAR JACK ASSEMBLY		
		ANGULAR ±1/2°				CHECKED BY JTR	DATE 1993/10/18	MOLEX INCORPORATED		
		DRAFT WHERE APPLICABLE MUST REMAIN WITHIN DIMENSIONS				APPROVED BY RAS	DATE 1993/10/18	MATERIAL NO. SEE SHT 3	DOCUMENT NO. SDA-43223	SHEET NO. 6 OF 6

12 11 10 9 8 7 6 5 4 3 2 1