

DESCRIPTION: COAXIAL/SIGNAL VERTICAL BOARD MOUNT

FACE VIEW OF RECEPTACLE IS SHOWN

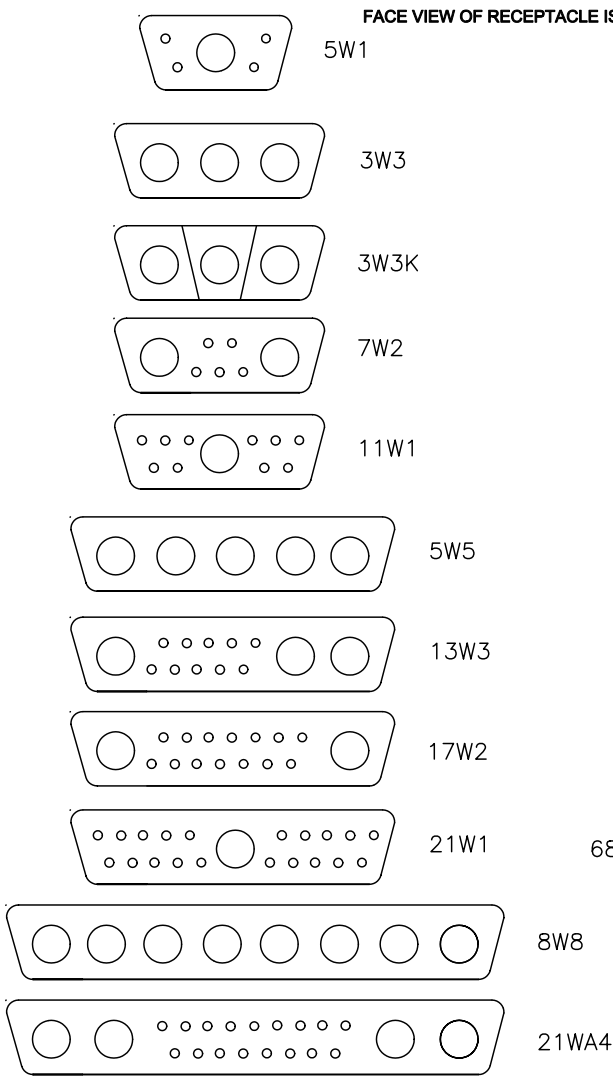

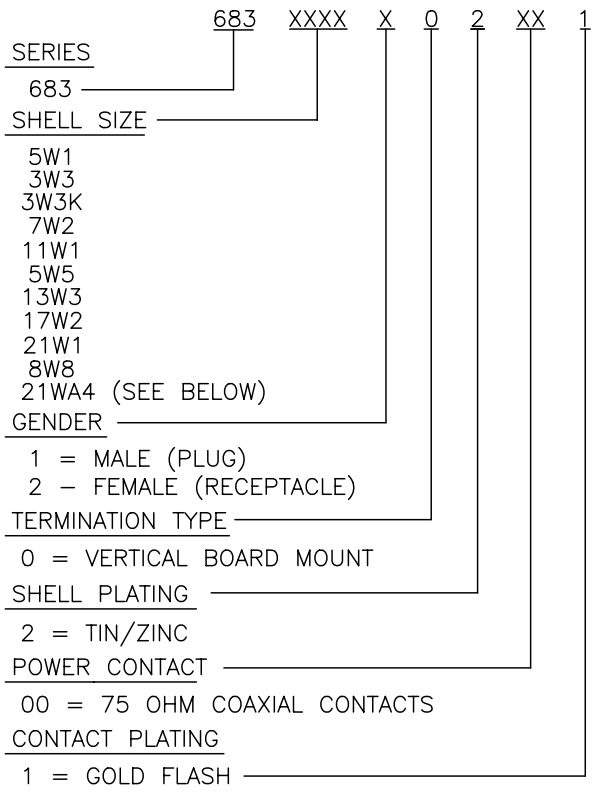

PART NUMBER KEY

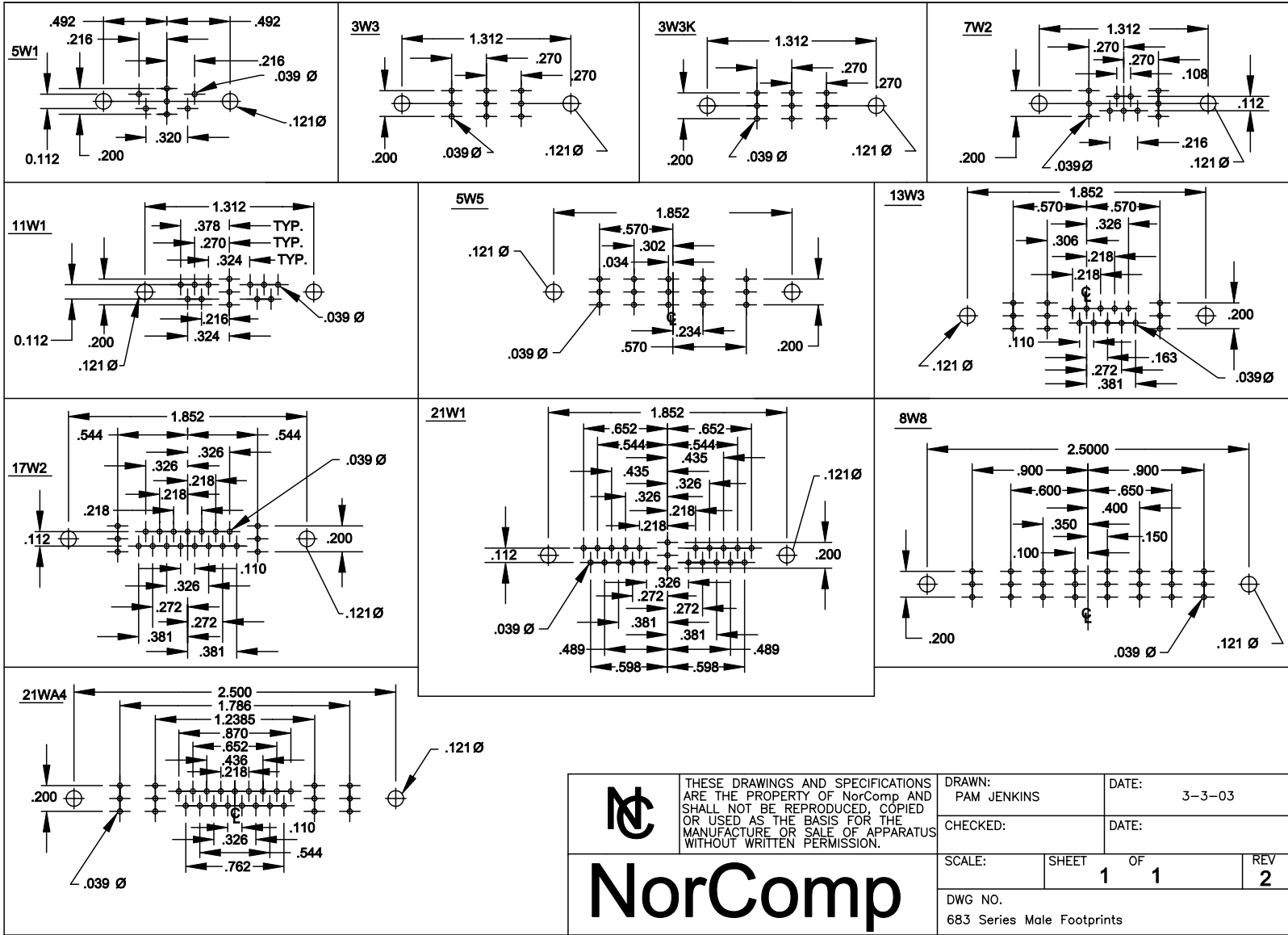

68321WA4 PART NUMBERS = 68321WA4P001 (MALE)
 68321WA4S001 (FEMALE)

| | | | | |
|-------------------------------------------------------------------------------------|---------------------------------------------------------------------------------------------------------------------------------------------------------------------------------------------|-------------------------------|-----------------------|-----------------|
|  | THESE DRAWINGS AND SPECIFICATIONS ARE THE PROPERTY OF NorComp AND SHALL NOT BE REPRODUCED, COPIED OR USED AS THE BASIS FOR THE MANUFACTURE OR SALE OF APPARATUS WITHOUT WRITTEN PERMISSION. | | DRAWN: PAM JENKINS | DATE: 6-5-02 |
| | | | CHECKED: | DATE: |
| <h1>NorComp</h1> | | SCALE: | SHEET 1 OF 1 | REV 2 |
| | | DWG NO. 683 SERIES CONNECTORS | | |





 THESE DRAWINGS AND SPECIFICATIONS ARE THE PROPERTY OF NorComp AND SHALL NOT BE REPRODUCED, COPIED OR USED AS THE BASIS FOR THE MANUFACTURE OR SALE OF APPARATUS WITHOUT WRITTEN PERMISSION.

NorComp

| | | | |
|---------------------------------------|------------|-----------------|----------|
| DRAWN: PAM JENKINS | | DATE: 3-3-03 | |
| CHECKED: | | DATE: | |
| SCALE: | SHEET 1 | OF 1 | REV 2 |
| DWG NO. 683 Series Male Footprints | | | |

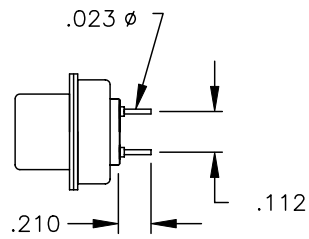
DESCRIPTION: SIGNAL/COAXIAL VERTICAL BOARD MOUNT



SIGNAL CONTACTS

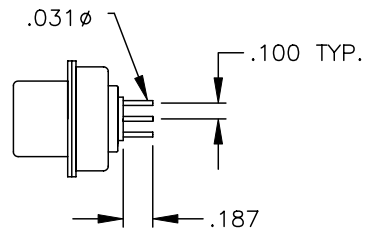

75 OHM COAXIAL CONTACT

NOTE: SIGNAL AND COAXIAL CONTACTS COME PRE-LOADED INTO INSULATOR.

| | | | | |
|-------------------------------------------------------------------------------------|---------------------------------------------------------------------------------------------------------------------------------------------------------------------------------------------|--------------------------------|----------------------------|-----------------|
|  | THESE DRAWINGS AND SPECIFICATIONS ARE THE PROPERTY OF NorComp AND SHALL NOT BE REPRODUCED, COPIED OR USED AS THE BASIS FOR THE MANUFACTURE OR SALE OF APPARATUS WITHOUT WRITTEN PERMISSION. | | DRAWN: PAM JENKINS | DATE: 6-5-02 |
| | <h1>NorComp</h1> | | CHECKED: | DATE: |
| SCALE: | | | SHEET 1 OF 1 | REV 2 |
| | | DWG NO. 683 XXXX X 0 2 XX 1 | | |

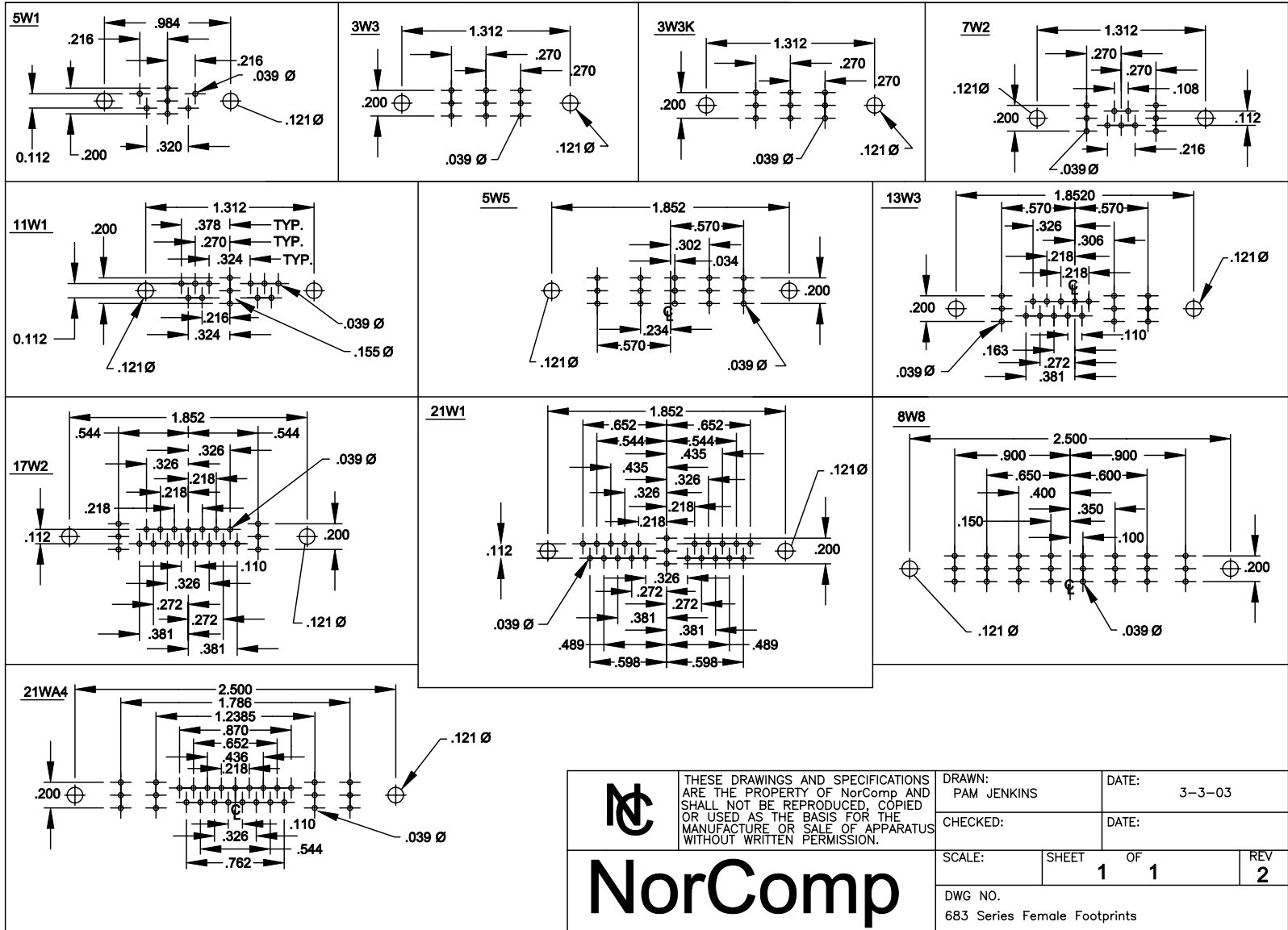

| | | | | |
|-------------------------------------------------------------------------------------|---------------------------------------------------------------------------------------------------------------------------------------------------------------------------------------------|-----------------------------------------|-----------------------|-----------------|
|  | THESE DRAWINGS AND SPECIFICATIONS ARE THE PROPERTY OF NorComp AND SHALL NOT BE REPRODUCED, COPIED OR USED AS THE BASIS FOR THE MANUFACTURE OR SALE OF APPARATUS WITHOUT WRITTEN PERMISSION. | | DRAWN: PAM JENKINS | DATE: 3-3-03 |
| | | | CHECKED: | DATE: |
| <h1>NorComp</h1> | | SCALE: | SHEET 1 OF 1 | REV 2 |
| | | DWG NO. 683 Series Female Footprints | | |