

DESCRIPTION: R/A .545 FOOTPRINT MACHINED - FEMALE

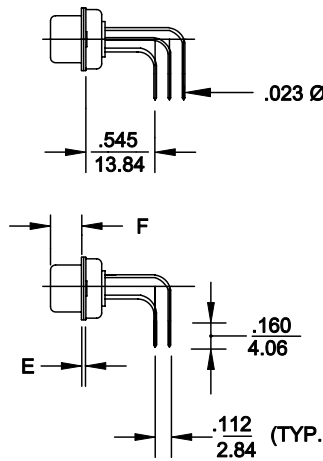

	A	B	C	E	F	G
9	1.213	.984	.494	.030	.243	0.436
	30.81	24.99	12.55	0.76	6.17	11.07
15	1.541	1.312	.494	.030	.243	0.763
	39.14	33.32	12.55	0.76	6.17	19.38
25	2.088	1.852	.494	.030	.243	1.308
	53.04	47.04	12.55	0.76	6.17	33.22
37	2.729	2.500	.494	.030	.243	1.962
	69.32	63.50	12.55	0.76	6.17	49.83
50	2.635	2.406	.605	.030	.243	1.744
	69.32	61.11	15.37	0.76	6.17	44.32

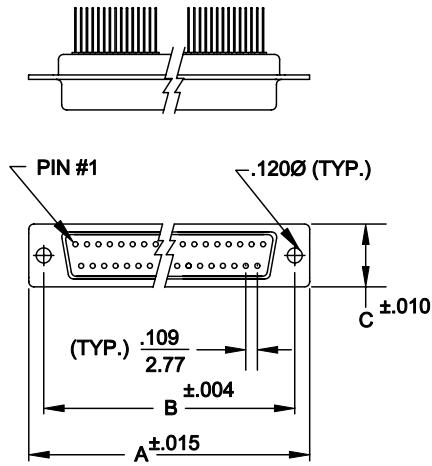
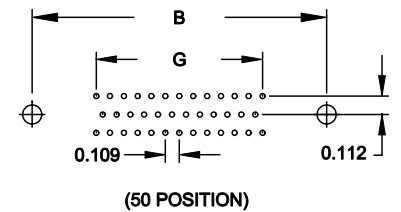
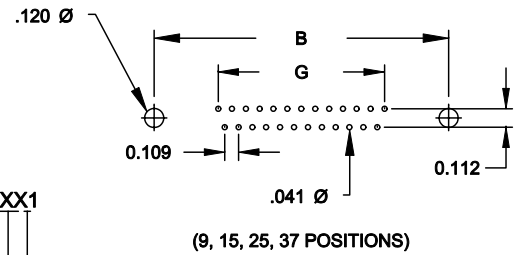

- 176-XXX-21X-XX1
- SERIES _____
 - POSITIONS _____
 - GENDER _____
 - 1 = MALE
 - 2 = FEMALE
 - TERMINATION _____
 - 1 = PC MOUNT
 - SHELL PLATING _____
 - 1 = YELLOW CHROMATE
 - 2 = TIN
 - HARDWARE OPTIONS _____
 - 00 = NO HARDWARE
 - 25 = LONG BRACKET WITH 4-40 SCREW
 - 15 = LONG BRACKET WITH 4-40 SCREW LOCK
 - PLATING OPTIONS _____
 - 1 = GOLD FLASH
 - 2 = 30 MICRO-INCH GOLD

SPECIFICATIONS:

MATERIALS:

SHELL: STEEL, YELLOW CHROMATE - TIN PLATED
 INSULATOR: UL 94V-0 RATED BEIGE PBT
 +30% FIBER-GLASS OR NYLON-66

ELECTRICALS:

CURRENT RATING: 5 AMPS
 CONTACT RESISTANCE: 15 MOHMS MAX
 INSULATOR RESISTANCE: 1000 MOHMS MIN
 VOLTAGE: 500V AC FOR 1 MINUTE
 TEMPERATURE: -50°C TO +100°C

	THESE DRAWINGS AND SPECIFICATIONS ARE THE PROPERTY OF NorComp AND SHALL NOT BE REPRODUCED, COPIED OR USED AS THE BASIS FOR THE MANUFACTURE OF APPARATUS WITHOUT WRITTEN PERMISSION.		DRAWN: WAYNE ROBBINS	DATE: 9-03-98
	NorComp		CHECKED:	DATE:
SCALE: 1:1			SHEET 1 OF 1	REV 4
DWG NO. 176-XXX-21X-001				

DESCRIPTION:

173/174 SERIES

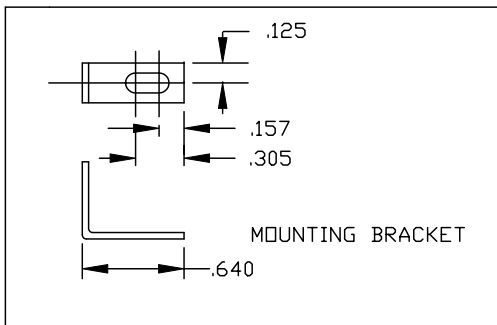

175/176 SERIES

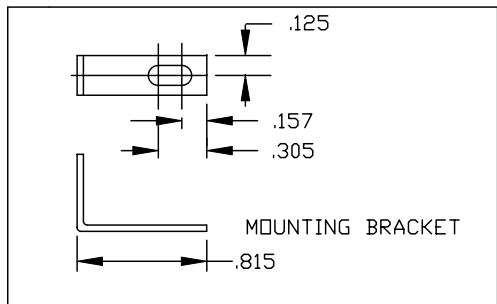

HARDWARE OPTIONS

REPLACE -XX IN LAST 3 DIGITS WITH OPTION CHOSEN

173/174 SERIES

14X = SHORT BRACKET & 4-40 FEMALE HEX SOCKET
 24X = SHORT BRACKET & 4-40 SCREW

175/176 SERIES

15X = LONG BRACKET & 4-40 FEMALE HEX SOCKET
 25X = LONG BRACKET & 4-40 SCREW

MATERIAL:
 COLD ROLLED STEEL
 PLATING:
 CLEAR ZINC OR YELLOW CHROMATE

	THESE DRAWINGS AND SPECIFICATIONS ARE THE PROPERTY OF NorComp AND SHALL NOT BE REPRODUCED, COPIED OR USED AS THE BASIS FOR THE MANUFACTURE OF SALE OF APPARATUS WITHOUT WRITTEN PERMISSION.		DRAWN: PAM JENKINS	DATE: 2-20-02
			CHECKED:	DATE:
<h1>NorComp</h1>		SCALE:	SHEET 1 OF 1	REV 1
		DWG NO. R/A BRACKET OPTIONS FOR MACHINED CONTACTS		