

DESCRIPTION: **RIGHT ANGLE .590" MALE PLASTIC D-SUB**

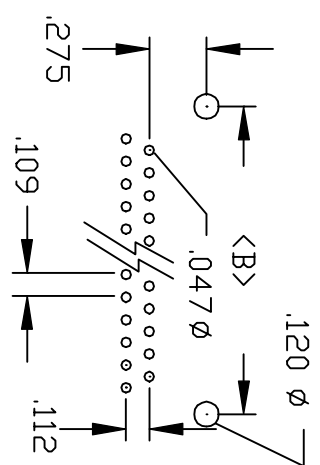

POS.	A	B	C	D	E
09	1.213	0.984	0.452	0.755	0.700
	30.80	24.99	11.48	19.18	17.78
15	1.543	1.312	0.452	1.081	1.402
	39.19	33.32	11.48	27.46	26.47
25	2.087	1.852	0.452	1.635	1.595
	53.00	47.04	11.48	41.53	40.51
37	2.732	2.500	0.452	2.264	2.231
	69.30	63.50	11.48	57.51	56.67

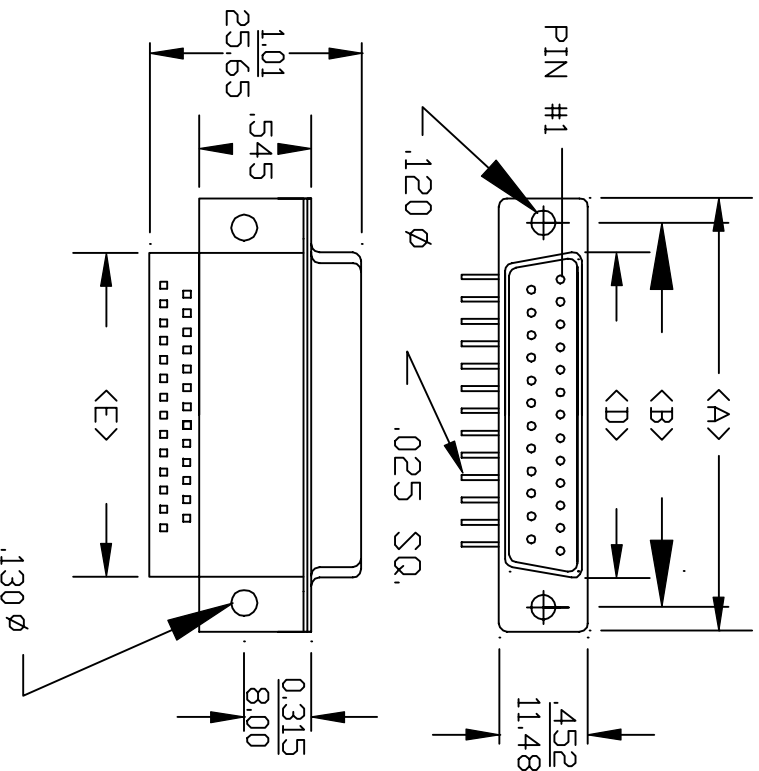
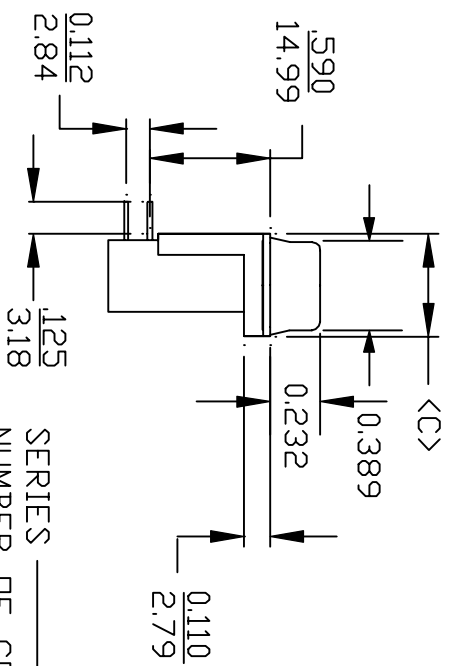

SPECIFICATIONS:

MATERIALS:

INSULATOR: UL 94V-0 RATED BLACK

GLASS FILLED POLYESTER

CONTACTS: PHOSPOR BRONZE - GOLD FLASH

ELECTRICALS:

CURRENT RATING: 5 AMPS

DIELECTRIC STRENGTH: 1000V AC RMS

INSULATION RESISTANCE: 1000 meg OHMS

CONTACT RESISTANCE: 10 MILLIOHMS MAX.

TEMPERATURE: -55°C TO +105°C

SERIES _____

NUMBER OF CONTACTS _____

GENDER: _____

1 = MALE

2 = FEMALE

PC MOUNT _____

SHELL MATERIAL _____

0 = ALL PLASTIC

HARDWARE OPTIONS: _____

(SEE PAGE 2)

PLATING: _____







1 = GOLD FLASH

177-XXX-110-XX1

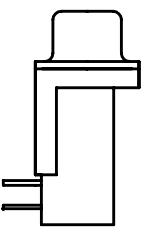
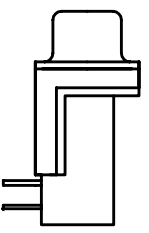
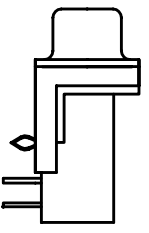
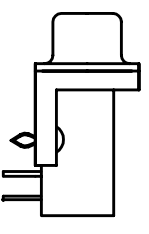
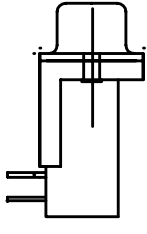
	THESE DRAWINGS AND SPECIFICATIONS ARE THE PROPERTY OF NorComp AND SHALL NOT BE REPRODUCED, COPIED OR USED AS THE BASIS FOR THE MANUFACTURE OR SALE OF APPARATUS WITHOUT WRITTEN PERMISSION.	
	DRAWN: PAM JENKINS	DATE: 9-23-98
CHECKED: _____	DATE: _____	
SCALE: _____	SHEET 1 OF 2	REV 5

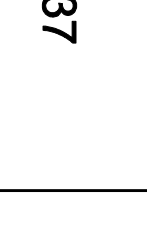
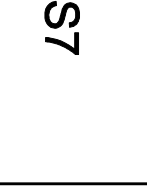
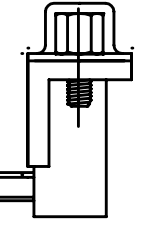
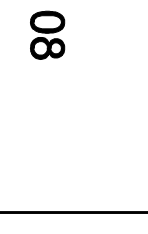
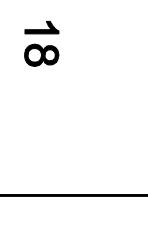
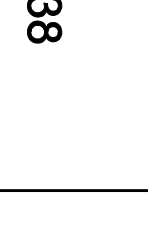
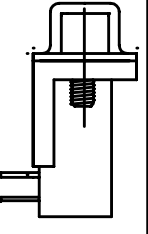
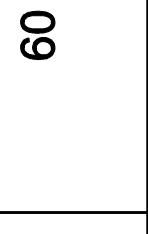
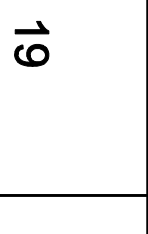
NorComp

DWG NO. _____	177-XXX-110-XX1
---------------	-----------------

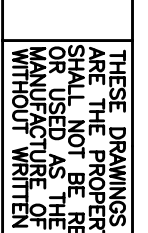
	PLASTIC SHELL		METAL SHELL WITH INSIDE GROUND STRAPS		METAL SHELL WITH RETAINING CLIP GROUND		PLASTIC SHELL WITH PLASTIC SNAP LOCK							
	06		07		16		36		06	.120" DIA. HOLE	06	16	36	S6
	08		17		37		07	17	37	S7				
	09		18		38		08	18	38	S8				
	19		39		S9 with washers									

N THESE DRAWINGS AND SPECIFICATIONS ARE THE PROPERTY OF NorComp AND SHALL NOT BE REPRODUCED, COPIED OR USED AS THE BASIS FOR THE MANUFACTURE OF APPARATUS WITHOUT WRITTEN PERMISSION.

NorComp

DRAWN: PAM JENKINS	DATE: 11-3-98
CHECKED:	DATE:
SCALE:	SHEET 2 OF 2
DWG NO.:	REV 3