

DESCRIPTION: FEMALE SOLDER CUP/MACHINED-PREMIUM

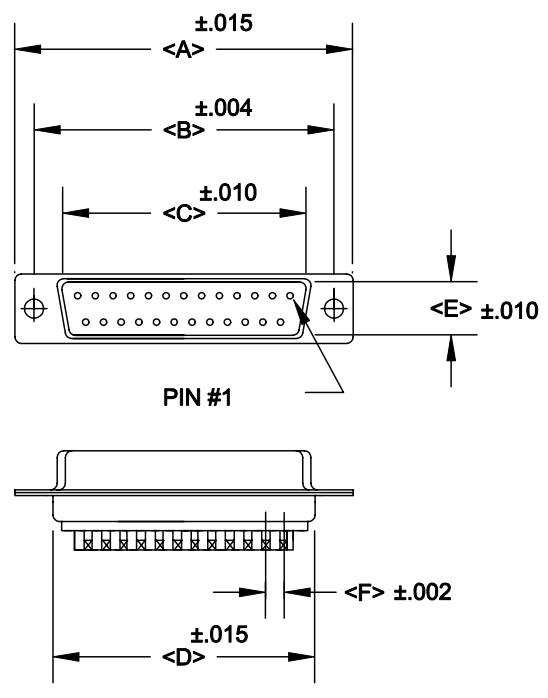

POS.	A	B	C	D	E	F	G
09	1.213	0.984	0.642	0.756	0.311	0.109	0.496
	30.80	24.99	16.30	19.20	7.90	2.77	12.60
15	1.541	1.312	0.971	1.091	0.311	0.109	0.496
	39.14	33.32	24.65	27.70	7.90	2.77	12.60
25	2.087	1.852	1.512	1.618	0.311	0.109	0.496
	53.00	47.04	38.40	41.10	7.90	2.77	12.60
37	2.728	2.500	2.157	2.256	0.311	0.109	0.496
	69.29	63.50	54.80	57.30	7.90	2.77	12.60
50	2.638	2.406	2.055	2.169	0.429	0.109	0.602
	67.00	61.00	52.20	55.10	10.90	2.77	15.30

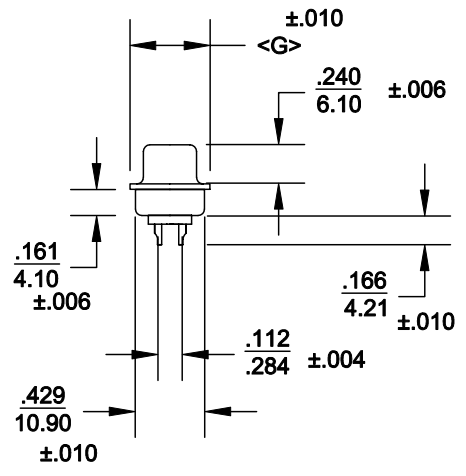

172-XXX-201-XX1

SERIES \_\_\_\_\_  
 POSITIONS \_\_\_\_\_  
 009 \_\_\_\_\_  
 015 \_\_\_\_\_  
 025 \_\_\_\_\_  
 037 \_\_\_\_\_  
 050 \_\_\_\_\_  
 GENDER \_\_\_\_\_  
 1 = MALE \_\_\_\_\_  
 2 = FEMALE \_\_\_\_\_  
 TERMINATION \_\_\_\_\_  
 0 = SOLDER CUP \_\_\_\_\_  
 SHELL PLATING \_\_\_\_\_  
 1 = YELLOW CHROMATE \_\_\_\_\_  
 2 = TIN \_\_\_\_\_  
 HARDWARE OPTIONS \_\_\_\_\_  
 00 = NO HARDWARE \_\_\_\_\_  
 01 = .065 4-40 CLINCH NUT BOARD SIDE \_\_\_\_\_  
 02 = .250 4-40 CLINCH NUT BOARD SIDE \_\_\_\_\_  
 03 = .250 4-40 CLINCH NUT MATING SIDE \_\_\_\_\_  
 PLATING OPTIONS \_\_\_\_\_  
 1 = GOLD FLASH \_\_\_\_\_  
 2 = 30 MICRO-INCH GOLD \_\_\_\_\_

**SPECIFICATIONS:**  
**MATERIALS:**  
 SHELL: STEEL, TIN OR YELLOW CHROMATE PLATED  
 INSULATOR: UL 94V-0 RATED PBT  
 +30% FIBER-GLASS OR NYLON-66  
**ELECTRICALS:**  
 CURRENT RATING: 5 AMPS  
 CONTACT RESISTANCE: 15 mOHMS MAX  
 INSULATOR RESISTANCE: 1000 MOHMS MIN  
 VOLTAGE: 500V AC FOR 1 MINUTE  
 TEMPERATURE: -50°C TO +100°C

WILL ACCEPT 28-20 AWG CONDUCTORS

	THESE DRAWINGS AND SPECIFICATIONS ARE THE PROPERTY OF NorComp AND SHALL NOT BE REPRODUCED, COPIED OR USED AS THE BASIS FOR THE MANUFACTURE OR SALE OF APPARATUS WITHOUT WRITTEN PERMISSION.	DRAWN: <b>PAM JENKINS</b> CHECKED:	DATE: <b>8-25-98</b> DATE:
	NorComp	SCALE:	SHEET OF
		DWG NO. <b>172-XXX-20X-XX1</b>	

**DESCRIPTION:** CLINCH NUT HARDWARE

ALL CLINCH-NUTS ARE 4-40 INTERNAL THREADS

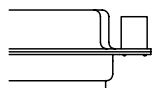

03X..... .250" (MATING SIDE) - CN8

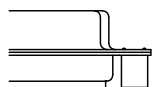

02X ..... .250" (BOARD SIDE) - CN2

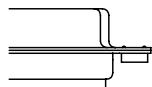

01X ..... .065" (BOARD SIDE) - CN1

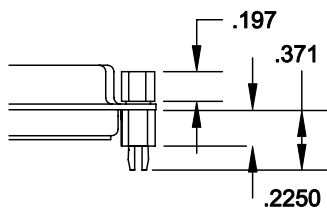

91X ..... .225" (BOARD SIDE) - .197 MATING SIDE - CN10/SFS0440  
NOTE: 4-40 FEMALE SCREW LOCK IS REMOVABLE

	THESE DRAWINGS AND SPECIFICATIONS ARE THE PROPERTY OF NorComp AND SHALL NOT BE REPRODUCED, COPIED OR USED AS THE BASIS FOR THE MANUFACTURE OF SALE OF APPARATUS WITHOUT WRITTEN PERMISSION.		DRAWN: WAYNE ROBBINS	DATE: 8-23-98
	NorComp		CHECKED: PAM JENKINS	DATE: 8-24-98
SCALE:			SHEET <b>1</b> OF <b>1</b>	REV <b>3</b>
DWG NO.		CLINCH-NUT OPTIONS		