

REV.	DATE	DESCRIPTION	BY	APP.
0	18-01-05	ECR-05-012760	JB	
-	-	-	-	-
-	-	-	-	-

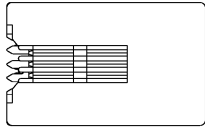

- NOTES:
- 1 TOLERANCE UNLESS OTHERWISE SPECIFIED: 0,15.
 - ⚠ BULK PACKAGING: TRUE POSITIONING OF THE SOLDER TINES IS NOT GUARANTEED.
 - ⚠ SUPERSEDED BY 1-215876-3

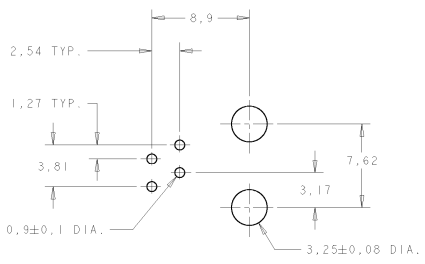
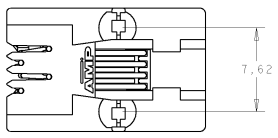
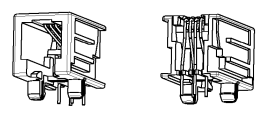
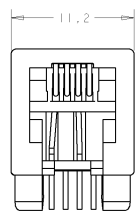
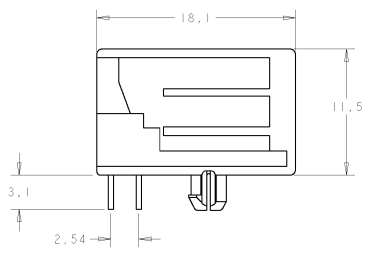
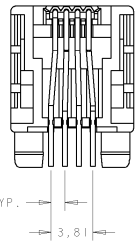

PRINTED CIRCUIT BOARD LAYOUT
 (VIEW SHOWN IS CIRCUIT (NON-COMPONENT) SIDE OF BOARD.)
 PRINTED CIRCUIT BOARD THICKNESS: 1,6mm NOMINAL.
 TOLERANCE UNLESS OTHERWISE SPECIFIED: ±0,05.

FINISH	MATERIAL	PACKAGING	PARTNUMBER
		290 PCS IN A TRAY	1-215875-3
		50 PCS IN A TUBE (SEE SHEET 2)	3-215875-3
		BULK PACKAGED IN A BOX	2-215875-1
		100 PIECES IN MULTI TUBE	⚠ 1-215875-1
		TAPE MOUNTED 1000pcs./tray	215875-1

DIMENSIONS: mm 		DIMENSIONS: INCHES 	
0 PLC	0	1 PLC	0
1 PLC	0	2 PLC	0
2 PLC	0	3 PLC	0
3 PLC	0	4 PLC	0
4 PLC	0	5 PLC	0
5 PLC	0	6 PLC	0
6 PLC	0	7 PLC	0
7 PLC	0	8 PLC	0
8 PLC	0	9 PLC	0
9 PLC	0	10 PLC	0
10 PLC	0	11 PLC	0
11 PLC	0	12 PLC	0
12 PLC	0	13 PLC	0
13 PLC	0	14 PLC	0
14 PLC	0	15 PLC	0
15 PLC	0	16 PLC	0
16 PLC	0	17 PLC	0
17 PLC	0	18 PLC	0
18 PLC	0	19 PLC	0
19 PLC	0	20 PLC	0
20 PLC	0	21 PLC	0
21 PLC	0	22 PLC	0
22 PLC	0	23 PLC	0
23 PLC	0	24 PLC	0
24 PLC	0	25 PLC	0
25 PLC	0	26 PLC	0
26 PLC	0	27 PLC	0
27 PLC	0	28 PLC	0
28 PLC	0	29 PLC	0
29 PLC	0	30 PLC	0
30 PLC	0	31 PLC	0
31 PLC	0	32 PLC	0
32 PLC	0	33 PLC	0
33 PLC	0	34 PLC	0
34 PLC	0	35 PLC	0
35 PLC	0	36 PLC	0
36 PLC	0	37 PLC	0
37 PLC	0	38 PLC	0
38 PLC	0	39 PLC	0
39 PLC	0	40 PLC	0
40 PLC	0	41 PLC	0
41 PLC	0	42 PLC	0
42 PLC	0	43 PLC	0
43 PLC	0	44 PLC	0
44 PLC	0	45 PLC	0
45 PLC	0	46 PLC	0
46 PLC	0	47 PLC	0
47 PLC	0	48 PLC	0
48 PLC	0	49 PLC	0
49 PLC	0	50 PLC	0
50 PLC	0	51 PLC	0
51 PLC	0	52 PLC	0
52 PLC	0	53 PLC	0
53 PLC	0	54 PLC	0
54 PLC	0	55 PLC	0
55 PLC	0	56 PLC	0
56 PLC	0	57 PLC	0
57 PLC	0	58 PLC	0
58 PLC	0	59 PLC	0
59 PLC	0	60 PLC	0
60 PLC	0	61 PLC	0
61 PLC	0	62 PLC	0
62 PLC	0	63 PLC	0
63 PLC	0	64 PLC	0
64 PLC	0	65 PLC	0
65 PLC	0	66 PLC	0
66 PLC	0	67 PLC	0
67 PLC	0	68 PLC	0
68 PLC	0	69 PLC	0
69 PLC	0	70 PLC	0
70 PLC	0	71 PLC	0
71 PLC	0	72 PLC	0
72 PLC	0	73 PLC	0
73 PLC	0	74 PLC	0
74 PLC	0	75 PLC	0
75 PLC	0	76 PLC	0
76 PLC	0	77 PLC	0
77 PLC	0	78 PLC	0
78 PLC	0	79 PLC	0
79 PLC	0	80 PLC	0
80 PLC	0	81 PLC	0
81 PLC	0	82 PLC	0
82 PLC	0	83 PLC	0
83 PLC	0	84 PLC	0
84 PLC	0	85 PLC	0
85 PLC	0	86 PLC	0
86 PLC	0	87 PLC	0
87 PLC	0	88 PLC	0
88 PLC	0	89 PLC	0
89 PLC	0	90 PLC	0
90 PLC	0	91 PLC	0
91 PLC	0	92 PLC	0
92 PLC	0	93 PLC	0
93 PLC	0	94 PLC	0
94 PLC	0	95 PLC	0
95 PLC	0	96 PLC	0
96 PLC	0	97 PLC	0
97 PLC	0	98 PLC	0
98 PLC	0	99 PLC	0
99 PLC	0	100 PLC	0

4

3

2

1

THIS DRAWING IS PUBLISHED BY Tyco Electronics Nederland B.V. ALL RIGHTS RESERVED.

LOC	SYST	REVISIONS		
H	-	LTR	DESCRIPTION	DATE
		**		**
		**		**
		**		**
		**		**

SEE SHEET 1

- NOTES:**
- 4 TUBE IS TRANSPARENT PVC.
 - △ TUBE IS CLOSED AT BOTH ENDS BY A TAPE.

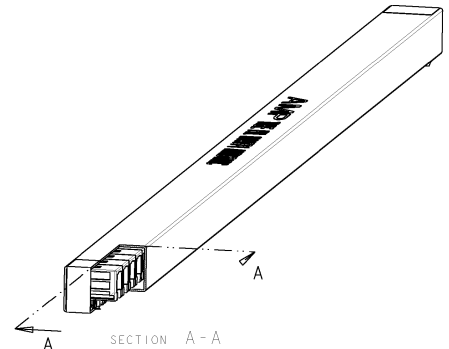
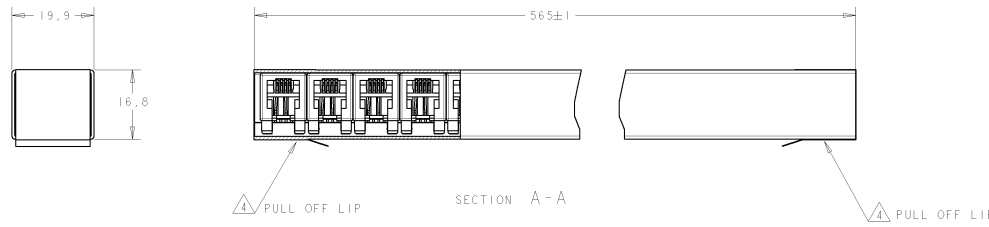

THIS DRAWING IS A CONTROLLED DOCUMENT. For Tyco Electronics Nederland B.V. ALL INFORMATION IS UNCLASSIFIED AND NOT FOR EXPORT CONTROL.		ON THIS SHEET PACKAGING IS SHOWN FOR 3-215877-3																																																																																																																																																																																																																																																																																																																																																																																																																																																																																																																																																																																																																																																																																																																																																																																																																																																																																																																																																																																																																																																																																																																																																																																																																																																																																																																																																																																																																																																																																																																																																																																																																																																																																														
DIMENSIONS: mm		SW EVELUX	AMP Tyco Electronics Nederland B.V. HERTOGMOEDER, THE NETHERLANDS																																																																																																																																																																																																																																																																																																																																																																																																																																																																																																																																																																																																																																																																																																																																																																																																																																																																																																																																																																																																																																																																																																																																																																																																																																																																																																																																																																																																																																																																																																																																																																																																																																																																																													
<table border="1"> <tr><td>0</td><td>PLC</td><td>0</td><td>*</td></tr> <tr><td>1</td><td>PLC</td><td>0</td><td>*</td></tr> <tr><td>2</td><td>PLC</td><td>0</td><td>*</td></tr> <tr><td>3</td><td>PLC</td><td>0</td><td>*</td></tr> <tr><td>4</td><td>PLC</td><td>0</td><td>*</td></tr> <tr><td>5</td><td>PLC</td><td>0</td><td>*</td></tr> <tr><td>6</td><td>PLC</td><td>0</td><td>*</td></tr> <tr><td>7</td><td>PLC</td><td>0</td><td>*</td></tr> <tr><td>8</td><td>PLC</td><td>0</td><td>*</td></tr> <tr><td>9</td><td>PLC</td><td>0</td><td>*</td></tr> <tr><td>0</td><td>PLC</td><td>0</td><td>*</td></tr> <tr><td>1</td><td>PLC</td><td>0</td><td>*</td></tr> <tr><td>2</td><td>PLC</td><td>0</td><td>*</td></tr> <tr><td>3</td><td>PLC</td><td>0</td><td>*</td></tr> <tr><td>4</td><td>PLC</td><td>0</td><td>*</td></tr> <tr><td>5</td><td>PLC</td><td>0</td><td>*</td></tr> <tr><td>6</td><td>PLC</td><td>0</td><td>*</td></tr> <tr><td>7</td><td>PLC</td><td>0</td><td>*</td></tr> <tr><td>8</td><td>PLC</td><td>0</td><td>*</td></tr> <tr><td>9</td><td>PLC</td><td>0</td><td>*</td></tr> <tr><td>0</td><td>PLC</td><td>0</td><td>*</td></tr> <tr><td>1</td><td>PLC</td><td>0</td><td>*</td></tr> <tr><td>2</td><td>PLC</td><td>0</td><td>*</td></tr> <tr><td>3</td><td>PLC</td><td>0</td><td>*</td></tr> <tr><td>4</td><td>PLC</td><td>0</td><td>*</td></tr> <tr><td>5</td><td>PLC</td><td>0</td><td>*</td></tr> <tr><td>6</td><td>PLC</td><td>0</td><td>*</td></tr> <tr><td>7</td><td>PLC</td><td>0</td><td>*</td></tr> <tr><td>8</td><td>PLC</td><td>0</td><td>*</td></tr> <tr><td>9</td><td>PLC</td><td>0</td><td>*</td></tr> <tr><td>0</td><td>PLC</td><td>0</td><td>*</td></tr> <tr><td>1</td><td>PLC</td><td>0</td><td>*</td></tr> <tr><td>2</td><td>PLC</td><td>0</td><td>*</td></tr> <tr><td>3</td><td>PLC</td><td>0</td><td>*</td></tr> <tr><td>4</td><td>PLC</td><td>0</td><td>*</td></tr> <tr><td>5</td><td>PLC</td><td>0</td><td>*</td></tr> <tr><td>6</td><td>PLC</td><td>0</td><td>*</td></tr> <tr><td>7</td><td>PLC</td><td>0</td><td>*</td></tr> <tr><td>8</td><td>PLC</td><td>0</td><td>*</td></tr> <tr><td>9</td><td>PLC</td><td>0</td><td>*</td></tr> <tr><td>0</td><td>PLC</td><td>0</td><td>*</td></tr> <tr><td>1</td><td>PLC</td><td>0</td><td>*</td></tr> <tr><td>2</td><td>PLC</td><td>0</td><td>*</td></tr> <tr><td>3</td><td>PLC</td><td>0</td><td>*</td></tr> <tr><td>4</td><td>PLC</td><td>0</td><td>*</td></tr> <tr><td>5</td><td>PLC</td><td>0</td><td>*</td></tr> <tr><td>6</td><td>PLC</td><td>0</td><td>*</td></tr> <tr><td>7</td><td>PLC</td><td>0</td><td>*</td></tr> <tr><td>8</td><td>PLC</td><td>0</td><td>*</td></tr> <tr><td>9</td><td>PLC</td><td>0</td><td>*</td></tr> <tr><td>0</td><td>PLC</td><td>0</td><td>*</td></tr> <tr><td>1</td><td>PLC</td><td>0</td><td>*</td></tr> <tr><td>2</td><td>PLC</td><td>0</td><td>*</td></tr> <tr><td>3</td><td>PLC</td><td>0</td><td>*</td></tr> <tr><td>4</td><td>PLC</td><td>0</td><td>*</td></tr> <tr><td>5</td><td>PLC</td><td>0</td><td>*</td></tr> <tr><td>6</td><td>PLC</td><td>0</td><td>*</td></tr> <tr><td>7</td><td>PLC</td><td>0</td><td>*</td></tr> <tr><td>8</td><td>PLC</td><td>0</td><td>*</td></tr> <tr><td>9</td><td>PLC</td><td>0</td><td>*</td></tr> <tr><td>0</td><td>PLC</td><td>0</td><td>*</td></tr> <tr><td>1</td><td>PLC</td><td>0</td><td>*</td></tr> <tr><td>2</td><td>PLC</td><td>0</td><td>*</td></tr> <tr><td>3</td><td>PLC</td><td>0</td><td>*</td></tr> <tr><td>4</td><td>PLC</td><td>0</td><td>*</td></tr> <tr><td>5</td><td>PLC</td><td>0</td><td>*</td></tr> <tr><td>6</td><td>PLC</td><td>0</td><td>*</td></tr> <tr><td>7</td><td>PLC</td><td>0</td><td>*</td></tr> <tr><td>8</td><td>PLC</td><td>0</td><td>*</td></tr> <tr><td>9</td><td>PLC</td><td>0</td><td>*</td></tr> <tr><td>0</td><td>PLC</td><td>0</td><td>*</td></tr> <tr><td>1</td><td>PLC</td><td>0</td><td>*</td></tr> <tr><td>2</td><td>PLC</td><td>0</td><td>*</td></tr> <tr><td>3</td><td>PLC</td><td>0</td><td>*</td></tr> <tr><td>4</td><td>PLC</td><td>0</td><td>*</td></tr> <tr><td>5</td><td>PLC</td><td>0</td><td>*</td></tr> <tr><td>6</td><td>PLC</td><td>0</td><td>*</td></tr> <tr><td>7</td><td>PLC</td><td>0</td><td>*</td></tr> <tr><td>8</td><td>PLC</td><td>0</td><td>*</td></tr> <tr><td>9</td><td>PLC</td><td>0</td><td>*</td></tr> <tr><td>0</td><td>PLC</td><td>0</td><td>*</td></tr> <tr><td>1</td><td>PLC</td><td>0</td><td>*</td></tr> <tr><td>2</td><td>PLC</td><td>0</td><td>*</td></tr> <tr><td>3</td><td>PLC</td><td>0</td><td>*</td></tr> <tr><td>4</td><td>PLC</td><td>0</td><td>*</td></tr> <tr><td>5</td><td>PLC</td><td>0</td><td>*</td></tr> <tr><td>6</td><td>PLC</td><td>0</td><td>*</td></tr> <tr><td>7</td><td>PLC</td><td>0</td><td>*</td></tr> <tr><td>8</td><td>PLC</td><td>0</td><td>*</td></tr> <tr><td>9</td><td>PLC</td><td>0</td><td>*</td></tr> <tr><td>0</td><td>PLC</td><td>0</td><td>*</td></tr> <tr><td>1</td><td>PLC</td><td>0</td><td>*</td></tr> <tr><td>2</td><td>PLC</td><td>0</td><td>*</td></tr> <tr><td>3</td><td>PLC</td><td>0</td><td>*</td></tr> <tr><td>4</td><td>PLC</td><td>0</td><td>*</td></tr> <tr><td>5</td><td>PLC</td><td>0</td><td>*</td></tr> <tr><td>6</td><td>PLC</td><td>0</td><td>*</td></tr> <tr><td>7</td><td>PLC</td><td>0</td><td>*</td></tr> <tr><td>8</td><td>PLC</td><td>0</td><td>*</td></tr> <tr><td>9</td><td>PLC</td><td>0</td><td>*</td></tr> <tr><td>0</td><td>PLC</td><td>0</td><td>*</td></tr> <tr><td>1</td><td>PLC</td><td>0</td><td>*</td></tr> <tr><td>2</td><td>PLC</td><td>0</td><td>*</td></tr> <tr><td>3</td><td>PLC</td><td>0</td><td>*</td></tr> <tr><td>4</td><td>PLC</td><td>0</td><td>*</td></tr> <tr><td>5</td><td>PLC</td><td>0</td><td>*</td></tr> <tr><td>6</td><td>PLC</td><td>0</td><td>*</td></tr> <tr><td>7</td><td>PLC</td><td>0</td><td>*</td></tr> <tr><td>8</td><td>PLC</td><td>0</td><td>*</td></tr> <tr><td>9</td><td>PLC</td><td>0</td><td>*</td></tr> <tr><td>0</td><td>PLC</td><td>0</td><td>*</td></tr> <tr><td>1</td><td>PLC</td><td>0</td><td>*</td></tr> <tr><td>2</td><td>PLC</td><td>0</td><td>*</td></tr> <tr><td>3</td><td>PLC</td><td>0</td><td>*</td></tr> <tr><td>4</td><td>PLC</td><td>0</td><td>*</td></tr> <tr><td>5</td><td>PLC</td><td>0</td><td>*</td></tr> <tr><td>6</td><td>PLC</td><td>0</td><td>*</td></tr> <tr><td>7</td><td>PLC</td><td>0</td><td>*</td></tr> <tr><td>8</td><td>PLC</td><td>0</td><td>*</td></tr> <tr><td>9</td><td>PLC</td><td>0</td><td>*</td></tr> <tr><td>0</td><td>PLC</td><td>0</td><td>*</td></tr> <tr><td>1</td><td>PLC</td><td>0</td><td>*</td></tr> <tr><td>2</td><td>PLC</td><td>0</td><td>*</td></tr> <tr><td>3</td><td>PLC</td><td>0</td><td>*</td></tr> <tr><td>4</td><td>PLC</td><td>0</td><td>*</td></tr> <tr><td>5</td><td>PLC</td><td>0</td><td>*</td></tr> <tr><td>6</td><td>PLC</td><td>0</td><td>*</td></tr> <tr><td>7</td><td>PLC</td><td>0</td><td>*</td></tr> <tr><td>8</td><td>PLC</td><td>0</td><td>*</td></tr> <tr><td>9</td><td>PLC</td><td>0</td><td>*</td></tr> <tr><td>0</td><td>PLC</td><td>0</td><td>*</td></tr> <tr><td>1</td><td>PLC</td><td>0</td><td>*</td></tr> <tr><td>2</td><td>PLC</td><td>0</td><td>*</td></tr> <tr><td>3</td><td>PLC</td><td>0</td><td>*</td></tr> <tr><td>4</td><td>PLC</td><td>0</td><td>*</td></tr> <tr><td>5</td><td>PLC</td><td>0</td><td>*</td></tr> <tr><td>6</td><td>PLC</td><td>0</td><td>*</td></tr> <tr><td>7</td><td>PLC</td><td>0</td><td>*</td></tr> <tr><td>8</td><td>PLC</td><td>0</td><td>*</td></tr> <tr><td>9</td><td>PLC</td><td>0</td><td>*</td></tr> <tr><td>0</td><td>PLC</td><td>0</td><td>*</td></tr> <tr><td>1</td><td>PLC</td><td>0</td><td>*</td></tr> <tr><td>2</td><td>PLC</td><td>0</td><td>*</td></tr> <tr><td>3</td><td>PLC</td><td>0</td><td>*</td></tr> <tr><td>4</td><td>PLC</td><td>0</td><td>*</td></tr> <tr><td>5</td><td>PLC</td><td>0</td><td>*</td></tr> <tr><td>6</td><td>PLC</td><td>0</td><td>*</td></tr> <tr><td>7</td><td>PLC</td><td>0</td><td>*</td></tr> <tr><td>8</td><td>PLC</td><td>0</td><td>*</td></tr> <tr><td>9</td><td>PLC</td><td>0</td><td>*</td></tr> <tr><td>0</td><td>PLC</td><td>0</td><td>*</td></tr> <tr><td>1</td><td>PLC</td><td>0</td><td>*</td></tr> <tr><td>2</td><td>PLC</td><td>0</td><td>*</td></tr> <tr><td>3</td><td>PLC</td><td>0</td><td>*</td></tr> <tr><td>4</td><td>PLC</td><td>0</td><td>*</td></tr> <tr><td>5</td><td>PLC</td><td>0</td><td>*</td></tr> <tr><td>6</td><td>PLC</td><td>0</td><td>*</td></tr> <tr><td>7</td><td>PLC</td><td>0</td><td>*</td></tr> <tr><td>8</td><td>PLC</td><td>0</td><td>*</td></tr> <tr><td>9</td><td>PLC</td><td>0</td><td>*</td></tr> <tr><td>0</td><td>PLC</td><td>0</td><td>*</td></tr> <tr><td>1</td><td>PLC</td><td>0</td><td>*</td></tr> <tr><td>2</td><td>PLC</td><td>0</td><td>*</td></tr> <tr><td>3</td><td>PLC</td><td>0</td><td>*</td></tr> <tr><td>4</td><td>PLC</td><td>0</td><td>*</td></tr> <tr><td>5</td><td>PLC</td><td>0</td><td>*</td></tr> <tr><td>6</td><td>PLC</td><td>0</td><td>*</td></tr> <tr><td>7</td><td>PLC</td><td>0</td><td>*</td></tr> <tr><td>8</td><td>PLC</td><td>0</td><td>*</td></tr> <tr><td>9</td><td>PLC</td><td>0</td><td>*</td></tr> <tr><td>0</td><td>PLC</td><td>0</td><td>*</td></tr> <tr><td>1</td><td>PLC</td><td>0</td><td>*</td></tr> <tr><td>2</td><td>PLC</td><td>0</td><td>*</td></tr> <tr><td>3</td><td>PLC</td><td>0</td><td>*</td></tr> <tr><td>4</td><td>PLC</td><td>0</td><td>*</td></tr> <tr><td>5</td><td>PLC</td><td>0</td><td>*</td></tr> <tr><td>6</td><td>PLC</td><td>0</td><td>*</td></tr> <tr><td>7</td><td>PLC</td><td>0</td><td>*</td></tr> <tr><td>8</td><td>PLC</td><td>0</td><td>*</td></tr> <tr><td>9</td><td>PLC</td><td>0</td><td>*</td></tr> <tr><td>0</td><td>PLC</td><td>0</td><td>*</td></tr> <tr><td>1</td><td>PLC</td><td>0</td><td>*</td></tr> <tr><td>2</td><td>PLC</td><td>0</td><td>*</td></tr> <tr><td>3</td><td>PLC</td><td>0</td><td>*</td></tr> <tr><td>4</td><td>PLC</td><td>0</td><td>*</td></tr> <tr><td>5</td><td>PLC</td><td>0</td><td>*</td></tr> <tr><td>6</td><td>PLC</td><td>0</td><td>*</td></tr> <tr><td>7</td><td>PLC</td><td>0</td><td>*</td></tr> <tr><td>8</td><td>PLC</td><td>0</td><td>*</td></tr> <tr><td>9</td><td>PLC</td><td>0</td><td>*</td></tr> <tr><td>0</td><td>PLC</td><td>0</td><td>*</td></tr> <tr><td>1</td><td>PLC</td><td>0</td><td>*</td></tr> <tr><td>2</td><td>PLC</td><td>0</td><td>*</td></tr> <tr><td>3</td><td>PLC</td><td>0</td><td>*</td></tr> <tr><td>4</td><td>PLC</td><td>0</td><td>*</td></tr> <tr><td>5</td><td>PLC</td><td>0</td><td>*</td></tr> <tr><td>6</td><td>PLC</td><td>0</td><td>*</td></tr> <tr><td>7</td><td>PLC</td><td>0</td><td>*</td></tr> <tr><td>8</td><td>PLC</td><td>0</td><td>*</td></tr> <tr><td>9</td><td>PLC</td><td>0</td><td>*</td></tr> <tr><td>0</td><td>PLC</td><td>0</td><td>*</td></tr> <tr><td>1</td><td>PLC</td><td>0</td><td>*</td></tr> <tr><td>2</td><td>PLC</td><td>0</td><td>*</td></tr> <tr><td>3</td><td>PLC</td><td>0</td><td>*</td></tr> <tr><td>4</td><td>PLC</td><td>0</td><td>*</td></tr> <tr><td>5</td><td>PLC</td><td>0</td><td>*</td></tr> <tr><td>6</td><td>PLC</td><td>0</td><td>*</td></tr> <tr><td>7</td><td>PLC</td><td>0</td><td>*</td></tr> <tr><td>8</td><td>PLC</td><td>0</td><td>*</td></tr> <tr><td>9</td><td>PLC</td><td>0</td><td>*</td></tr> <tr><td>0</td><td>PLC</td><td>0</td><td>*</td></tr> <tr><td>1</td><td>PLC</td><td>0</td><td>*</td></tr> <tr><td>2</td><td>PLC</td><td>0</td><td>*</td></tr> <tr><td>3</td><td>PLC</td><td>0</td><td>*</td></tr> <tr><td>4</td><td>PLC</td><td>0</td><td>*</td></tr> <tr><td>5</td><td>PLC</td><td>0</td><td>*</td></tr> <tr><td>6</td><td>PLC</td><td>0</td><td>*</td></tr> <tr><td>7</td><td>PLC</td><td>0</td><td>*</td></tr> <tr><td>8</td><td>PLC</td><td>0</td><td>*</td></tr> <tr><td>9</td><td>PLC</td><td>0</td><td>*</td></tr> <tr><td>0</td><td>PLC</td><td>0</td><td>*</td></tr> <tr><td>1</td><td>PLC</td><td>0</td><td>*</td></tr> <tr><td>2</td><td>PLC</td><td>0</td><td>*</td></tr> <tr><td>3</td><td>PLC</td><td>0</td><td>*</td></tr> <tr><td>4</td><td>PLC</td><td>0</td><td>*</td></tr> <tr><td>5</td><td>PLC</td><td>0</td><td>*</td></tr> <tr><td>6</td><td>PLC</td><td>0</td><td>*</td></tr> <tr><td>7</td><td>PLC</td><td>0</td><td>*</td></tr> <tr><td>8</td><td>PLC</td><td>0</td><td>*</td></tr> <tr><td>9</td><td>PLC</td><td>0</td><td>*</td></tr> <tr><td>0</td><td>PLC</td><td>0</td><td>*</td></tr> <tr><td>1</td><td>PLC</td><td>0</td><td>*</td></tr> <tr><td>2</td><td>PLC</td><td>0</td><td>*</td></tr> <tr><td>3</td><td>PLC</td><td>0</td><td>*</td></tr> <tr><td>4</td><td>PLC</td><td>0</td><td>*</td></tr> <tr><td>5</td><td>PLC</td><td>0</td><td>*</td></tr> <tr><td>6</td><td>PLC</td><td>0</td><td>*</td></tr> <tr><td>7</td><td>PLC</td><td>0</td><td>*</td></tr> <tr><td>8</td><td>PLC</td><td>0</td><td>*</td></tr> <tr><td>9</td><td>PLC</td><td>0</td><td>*</td></tr> <tr><td>0</td><td>PLC</td><td>0</td><td>*</td></tr> <tr><td>1</td><td>PLC</td><td>0</td><td>*</td></tr> <tr><td>2</td><td>PLC</td><td>0</td><td>*</td></tr> <tr><td>3</td><td>PLC</td><td>0</td><td>*</td></tr> <tr><td>4</td><td>PLC</td><td>0</td><td>*</td></tr> <tr><td>5</td><td>PLC</td><td>0</td><td>*</td></tr> <tr><td>6</td><td>PLC</td><td>0</td><td>*</td></tr> <tr><td>7</td><td>PLC</td><td>0</td><td>*</td></tr> <tr><td>8</td><td>PLC</td><td>0</td><td>*</td></tr> <tr><td>9</td><td>PLC</td><td>0</td><td>*</td></tr> <tr><td>0</td><td>PLC</td><td>0</td><td>*</td></tr> <tr><td>1</td><td>PLC</td><td>0</td><td>*</td></tr> <tr><td>2</td><td>PLC</td><td>0</td><td>*</td></tr> <tr><td>3</td><td>PLC</td><td>0</td><td>*</td></tr> <tr><td>4</td><td>PLC</td><td>0</td><td>*</td></tr> <tr><td>5</td><td>PLC</td><td>0</td><td>*</td></tr> <tr><td>6</td><td>PLC</td><td>0</td><td>*</td></tr> <tr><td>7</td><td>PLC</td><td>0</td><td>*</td></tr> <tr><td>8</td><td>PLC</td><td>0</td><td>*</td></tr> <tr><td>9</td><td>PLC</td><td>0</td><td>*</td></tr> <tr><td>0</td><td>PLC</td><td>0</td><td>*</td></tr> <tr><td>1</td><td>PLC</td><td>0</td><td>*</td></tr> <tr><td>2</td><td>PLC</td><td>0</td><td>*</td></tr> <tr><td>3</td><td>PLC</td><td>0</td><td>*</td></tr> <tr><td>4</td><td>PLC</td><td>0</td><td>*</td></tr> <tr><td>5</td><td>PLC</td><td>0</td><td>*</td></tr> <tr><td>6</td><td>PLC</td><td>0</td><td>*</td></tr> <tr><td>7</td><td>PLC</td><td>0</td><td>*</td></tr> <tr><td>8</td><td>PLC</td><td>0</td><td>*</td></tr> <tr><td>9</td><td>PLC</td><td>0</td><td>*</td></tr> <tr><td>0</td><td>PLC</td><td>0</td><td>*</td></tr> <tr><td>1</td><td>PLC</td><td>0</td><td>*</td></tr> <tr><td>2</td><td>PLC</td><td>0</td><td>*</td></tr> <tr><td>3</td><td>PLC</td><td>0</td><td>*</td></tr> <tr><td>4</td><td>PLC</td><td>0</td><td>*</td></tr> <tr><td>5</td><td>PLC</td><td>0</td><td>*</td></tr> <tr><td>6</td><td>PLC</td><td>0</td><td>*</td></tr> <tr><td>7</td><td>PLC</td><td>0</td><td>*</td></tr> <tr><td>8</td><td>PLC</td><td>0</td><td>*</td></tr> <tr><td>9</td><td>PLC</td><td>0</td><td>*</td></tr> <tr><td>0</td><td>PLC</td><td>0</td><td>*</td></tr> <tr><td>1</td><td>PLC</td><td>0</td><td>*</td></tr> <tr><td>2</td><td>PLC</td><td>0</td><td>*</td></tr> <tr><td>3</td><td>PLC</td><td>0</td><td>*</td></tr> <tr><td>4</td><td>PLC</td><td>0</td><td>*</td></tr> <tr><td>5</td><td>PLC</td><td>0</td><td>*</td></tr> <tr><td>6</td><td>PLC</td><td>0</td><td>*</td></tr> <tr><td>7</td><td>PLC</td><td>0</td><td>*</td></tr> <tr><td>8</td><td>PLC</td><td>0</td><td>*</td></tr> <tr><td>9</td><td>PLC</td><td>0</td><td>*</td></tr> <tr><td>0</td><td>PLC</td><td>0</td><td>*</td></tr> <tr><td>1</td><td>PLC</td><td>0</td><td>*</td></tr> <tr><td>2</td><td>PLC</td><td>0</td><td>*</td></tr> <tr><td>3</td><td>PLC</td><td>0</td><td>*</td></tr> <tr><td>4</td><td>PLC</td><td>0</td><td>*</td></tr> <tr><td>5</td><td>PLC</td><td>0</td><td>*</td></tr> <tr><td>6</td><td>PLC</td><td>0</td><td>*</td></tr> <tr><td>7</td><td>PLC</td><td>0</td><td>*</td></tr> <tr><td>8</td><td>PLC</td><td>0</td><td>*</td></tr> <tr><td>9</td><td>PLC</td><td>0</td><td>*</td></tr> <tr><td>0</td><td>PLC</td><td>0</td><td>*</td></tr> <tr><td>1</td><td>PLC</td><td>0</td><td>*</td></tr> <tr><td>2</td><td>PLC</td><td>0</td><td>*</td></tr> <tr><td>3</td><td>PLC</td><td>0</td><td>*</td></tr> <tr><td>4</td><td>PLC</td><td>0</td><td>*</td></tr> <tr><td>5</td><td>PLC</td><td>0</td><td>*</td></tr> <tr><td>6</td><td>PLC</td><td>0</td><td>*</td></tr> <tr><td>7</td><td>PLC</td><td>0</td><td>*</td></tr> <tr><td>8</td><td>PLC</td><td>0</td><td>*</td></tr> <tr><td>9</td><td>PLC</td><td>0</td><td>*</td></tr> <tr><td>0</td><td>PLC</td><td>0</td><td>*</td></tr> <tr><td>1</td><td>PLC</td><td>0</td><td>*</td></tr> <tr><td>2</td><td>PLC</td><td>0</td><td>*</td></tr> <tr><td>3</td><td>PLC</td><td>0</td><td>*</td></tr> <tr><td>4</td><td>PLC</td><td>0</td><td>*</td></tr> <tr><td>5</td><td>PLC</td><td>0</td><td>*</td></tr> <tr><td>6</td><td>PLC</td><td>0</td><td>*</td></tr> <tr><td>7</td><td>PLC</td><td>0</td><td>*</td></tr> <tr><td>8</td><td>PLC</td><td>0</td><td>*</td></tr> <tr><td>9</td><td>PLC</td><td>0</td><td>*</td></tr> <tr><td>0</td><td>PLC</td><td>0</td><td>*</td></tr> <tr><td>1</td><td>PLC</td><td>0</td><td>*</td></tr> <tr><td>2</td><td>PLC</td><td>0</td><td>*</td></tr> <tr><td>3</td><td>PLC</td><td>0</td><td>*</td></tr> <tr><td>4</td><td>PLC</td><td>0</td><td>*</td></tr> <tr><td>5</td><td>PLC</td><td>0</td><td>*</td></tr> <tr><td>6</td><td>PLC</td><td>0</td><td>*</td></tr> <tr><td>7</td><td>PLC</td><td>0</td><td>*</td></tr> <tr><td>8</td><td>PLC</td><td>0</td><td>*</td></tr> <tr><td>9</td><td>PLC</td><td>0</td><td>*</td></tr> <tr><td>0</td><td>PLC</td><td>0</td><td>*</td></tr> <tr><td>1</td><td>PLC</td><td>0</td><td>*</td></tr> <tr><td>2</td><td>PLC</td><td>0</td><td>*</td></tr> <tr><td>3</td><td>PLC</td><td>0</td><td>*</td></tr> <tr><td>4</td><td>PLC</td><td>0</td><td>*</td></tr> <tr><td>5</td><td>PLC</td><td>0</td><td>*</td></tr> <tr><td>6</td><td>PLC</td><td>0</td><td>*</td></tr> <tr><td>7</td><td>PLC</td><td>0</td><td>*</td></tr> <tr><td>8</td><td>PLC</td><td>0</td><td>*</td></tr> <tr><td>9</td><td>PLC</td><td>0</td><td>*</td></tr> <tr><td>0</td><td>PLC</td><td>0</td><td>*</td></tr> <tr><td>1</td><td>PLC</td><td>0</td><td>*</td></tr> <tr><td>2</td><td>PLC</td><td>0</td><td>*</td></tr> <tr><td>3</td><td>PLC</td><td>0</td><td>*</td></tr> <tr><td>4</td><td>PLC</td><td>0</td><td>*</td></tr> <tr><td>5</td><td>PLC</td><td>0</td><td>*</td></tr> <tr><td>6</td><td>PLC</td><td>0</td><td>*</td></tr> <tr><td>7</td><td>PLC</td><td>0</td><td>*</td></tr> <tr><td>8</td><td>PLC</td><td>0</td><td>*</td></tr> <tr><td>9</td><td>PLC</td><td>0</td><td>*</td></tr> <tr><td>0</td><td>PLC</td><td>0</td><td>*</td></tr> <tr><td>1</td><td>PLC</td><td>0</td><td>*</td></tr> <tr><td>2</td><td>PLC</td><td>0</td><td>*</td></tr> <tr><td>3</td><td>PLC</td><td>0</td><td>*</td></tr> <tr><td>4</td><td>PLC</td><td>0</td><td>*</td></tr> <tr><td>5</td><td>PLC</td><td>0</td><td>*</td></tr> <tr><td>6</td><td>PLC</td><td>0</td><td>*</td></tr> <tr><td>7</td><td>PLC</td><td>0</td><td>*</td></tr> <tr><td>8</td><td>PLC</td><td>0</td><td>*</td></tr> <tr><td>9</td><td>PLC</td><td>0</td><td>*</td></tr> <tr><td>0</td><td>PLC</td><td>0</td><td>*</td></tr> <tr><td>1</td><td>PLC</td><td>0</td><td>*</td></tr> <tr><td>2</td><td>PLC</td><td>0</td><td>*</td></tr> <tr><td>3</td><td>PLC</td><td>0</td><td>*</td></tr> <tr><td>4</td><td>PLC</td><td>0</td><td>*</td></tr> <tr><td>5</td><td>PLC</td><td>0</td><td>*</td></tr> <tr><td>6</td><td>PLC</td><td>0</td><td>*</td></tr> <tr><td>7</td><td>PLC</td><td>0</td><td>*</td></tr> <tr><td>8</td><td>PLC</td><td>0</td><td>*</td></tr> <tr><td>9</td><td>PLC</td><td>0</td><td>*</td></tr> <tr><td>0</td><td>PLC</td><td>0</td><td>*</td></tr> <tr><td>1</td><td>PLC</td><td>0</td><td>*</td></tr> <tr><td>2</td><td>PLC</td><td>0</td><td>*</td></tr> <tr><td>3</td><td>PLC</td><td>0</td><td>*</td></tr> <tr><td>4</td><td>PLC</td><td>0</td><td>*</td></tr> <tr><td>5</td><td>PLC</td><td>0</td><td>*</td></tr> <tr><td>6</td><td>PLC</td><td>0</td><td>*</td></tr> <tr><td>7</td><td>PLC</td><td>0</td><td>*</td></tr> <tr><td>8</td><td>PLC</td><td>0</td><td>*</td></tr> <tr><td>9</td><td>PLC</td><td>0</td><td>*</td></tr> <tr><td>0</td><td>PLC</td><td>0</td><td>*</td></tr> <tr><td>1</td><td>PLC</td><td>0</td><td>*</td></tr> <tr><td>2</td><td>PLC</td><td>0</td><td>*</td></tr> <tr><td>3</td><td>PLC</td><td>0</td><td>*</td></tr> <tr><td>4</td><td>PLC</td><td>0</td><td>*</td></tr> <tr><td>5</td><td>PLC</td><td>0</td><td>*</td></tr> <tr><td>6</td><td>PLC</td><td>0</td><td>*</td></tr> <tr><td>7</td><td>PLC</td><td>0</td><td>*</td></tr> <tr><td>8</td><td>PLC</td><td>0</td><td>*</td></tr> <tr><td>9</td><td>PLC</td><td>0</td><td>*</td></tr> <tr><td>0</td><td>PLC</td><td>0</td><td>*</td></tr> <tr><td>1</td><td>PLC</td><td>0</td><td>*</td></tr> <tr><td>2</td><td>PLC</td><td>0</td><td>*</td></tr> <tr><td>3</td><td>PLC</td><td>0</td><td>*</td></tr> <tr><td>4</td><td>PLC</td><td>0</td><td>*</td></tr> <tr><td>5</td><td>PLC</td><td>0</td><td>*</td></tr> <tr><td>6</td><td>PLC</td><td>0</td><td>*</td></tr> <tr><td>7</td><td>PLC</td><td>0</td><td>*</td></tr> <tr><td>8</td><td>PLC</td><td>0</td><td>*</td></tr> <tr><td>9</td><td>PLC</td><td>0</td><td>*</td></tr> <tr><td>0</td><td>PLC</td><td>0</td><td>*</td></tr> <tr><td>1</td><td>PLC</td><td>0</td><td>*</td></tr> <tr><td>2</td><td>PLC</td><td>0</td><td>*</td></tr> <tr><td>3</td><td>PLC</td><td>0</td><td>*</td></tr> <tr><td>4</td><td>PLC</td><td>0</td><td>*</td></tr> <tr><td>5</td><td>PLC</td><td>0</td><td>*</td></tr> <tr><td>6</td><td>PLC</td><td>0</td><td>*</td></tr> <tr><td>7</td><td>PLC</td><td>0</td></tr></table>		0		PLC	0	*	1	PLC	0	*	2	PLC	0	*	3	PLC	0	*	4	PLC	0	*	5	PLC	0	*	6	PLC	0	*	7	PLC	0	*	8	PLC	0	*	9	PLC	0	*	0	PLC	0	*	1	PLC	0	*	2	PLC	0	*	3	PLC	0	*	4	PLC	0	*	5	PLC	0	*	6	PLC	0	*	7	PLC	0	*	8	PLC	0	*	9	PLC	0	*	0	PLC	0	*	1	PLC	0	*	2	PLC	0	*	3	PLC	0	*	4	PLC	0	*	5	PLC	0	*	6	PLC	0	*	7	PLC	0	*	8	PLC	0	*	9	PLC	0	*	0	PLC	0	*	1	PLC	0	*	2	PLC	0	*	3	PLC	0	*	4	PLC	0	*	5	PLC	0	*	6	PLC	0	*	7	PLC	0	*	8	PLC	0	*	9	PLC	0	*	0	PLC	0	*	1	PLC	0	*	2	PLC	0	*	3	PLC	0	*	4	PLC	0	*	5	PLC	0	*	6	PLC	0	*	7	PLC	0	*	8	PLC	0	*	9	PLC	0	*	0	PLC	0	*	1	PLC	0	*	2	PLC	0	*	3	PLC	0	*	4	PLC	0	*	5	PLC	0	*	6	PLC	0	*	7	PLC	0	*	8	PLC	0	*	9	PLC	0	*	0	PLC	0	*	1	PLC	0	*	2	PLC	0	*	3	PLC	0	*	4	PLC	0	*	5	PLC	0	*	6	PLC	0	*	7	PLC	0	*	8	PLC	0	*	9	PLC	0	*	0	PLC	0	*	1	PLC	0	*	2	PLC	0	*	3	PLC	0	*	4	PLC	0	*	5	PLC	0	*	6	PLC	0	*	7	PLC	0	*	8	PLC	0	*	9	PLC	0	*	0	PLC	0	*	1	PLC	0	*	2	PLC	0	*	3	PLC	0	*	4	PLC	0	*	5	PLC	0	*	6	PLC	0	*	7	PLC	0	*	8	PLC	0	*	9	PLC	0	*	0	PLC	0	*	1	PLC	0	*	2	PLC	0	*	3	PLC	0	*	4	PLC	0	*	5	PLC	0	*	6	PLC	0	*	7	PLC	0	*	8	PLC	0	*	9	PLC	0	*	0	PLC	0	*	1	PLC	0	*	2	PLC	0	*	3	PLC	0	*	4	PLC	0	*	5	PLC	0	*	6	PLC	0	*	7	PLC	0	*	8	PLC	0	*	9	PLC	0	*	0	PLC	0	*	1	PLC	0	*	2	PLC	0	*	3	PLC	0	*	4	PLC	0	*	5	PLC	0	*	6	PLC	0	*	7	PLC	0	*	8	PLC	0	*	9	PLC	0	*	0	PLC	0	*	1	PLC	0	*	2	PLC	0	*	3	PLC	0	*	4	PLC	0	*	5	PLC	0	*	6	PLC	0	*	7	PLC	0	*	8	PLC	0	*	9	PLC	0	*	0	PLC	0	*	1	PLC	0	*	2	PLC	0	*	3	PLC	0	*	4	PLC	0	*	5	PLC	0	*	6	PLC	0	*	7	PLC	0	*	8	PLC	0	*	9	PLC	0	*	0	PLC	0	*	1	PLC	0	*	2	PLC	0	*	3	PLC	0	*	4	PLC	0	*	5	PLC	0	*	6	PLC	0	*	7	PLC	0	*	8	PLC	0	*	9	PLC	0	*	0	PLC	0	*	1	PLC	0	*	2	PLC	0	*	3	PLC	0	*	4	PLC	0	*	5	PLC	0	*	6	PLC	0	*	7	PLC	0	*	8	PLC	0	*	9	PLC	0	*	0	PLC	0	*	1	PLC	0	*	2	PLC	0	*	3	PLC	0	*	4	PLC	0	*	5	PLC	0	*	6	PLC	0	*	7	PLC	0	*	8	PLC	0	*	9	PLC	0	*	0	PLC	0	*	1	PLC	0	*	2	PLC	0	*	3	PLC	0	*	4	PLC	0	*	5	PLC	0	*	6	PLC	0	*	7	PLC	0	*	8	PLC	0	*	9	PLC	0	*	0	PLC	0	*	1	PLC	0	*	2	PLC	0	*	3	PLC	0	*	4	PLC	0	*	5	PLC	0	*	6	PLC	0	*	7	PLC	0	*	8	PLC	0	*	9	PLC	0	*	0	PLC	0	*	1	PLC	0	*	2	PLC	0	*	3	PLC	0	*	4	PLC	0	*	5	PLC	0	*	6	PLC	0	*	7	PLC	0	*	8	PLC	0	*	9	PLC	0	*	0	PLC	0	*	1	PLC	0	*	2	PLC	0	*	3	PLC	0	*	4	PLC	0	*	5	PLC	0	*	6	PLC	0	*	7	PLC	0	*	8	PLC	0	*	9	PLC	0	*	0	PLC	0	*	1	PLC	0	*	2	PLC	0	*	3	PLC	0	*	4	PLC	0	*	5	PLC	0	*	6	PLC	0	*	7	PLC	0	*	8	PLC	0	*	9	PLC	0	*	0	PLC	0	*	1	PLC	0	*	2	PLC	0	*	3	PLC	0	*	4	PLC	0	*	5	PLC	0	*	6	PLC	0	*	7	PLC	0	*	8	PLC	0	*	9	PLC	0	*	0	PLC	0	*	1	PLC	0	*	2	PLC	0	*	3	PLC	0	*	4	PLC	0	*	5	PLC	0	*	6	PLC	0	*	7	PLC	0	*	8	PLC	0	*	9	PLC	0	*	0	PLC	0	*	1	PLC	0	*	2	PLC	0	*	3	PLC	0	*	4	PLC	0	*	5	PLC	0	*	6	PLC	0	*	7	PLC	0	*	8	PLC	0	*	9	PLC	0	*	0	PLC	0	*	1	PLC	0	*	2	PLC	0	*	3	PLC	0	*	4	PLC	0	*	5	PLC	0	*	6	PLC	0	*	7	PLC	0	*	8	PLC	0	*	9	PLC	0	*	0	PLC	0	*	1	PLC	0	*	2	PLC	0	*	3	PLC	0	*	4	PLC	0	*	5	PLC	0	*	6	PLC	0	*	7	PLC	0	*	8	PLC	0	*	9	PLC	0	*	0	PLC	0	*	1	PLC	0	*	2	PLC	0	*	3	PLC	0	*	4	PLC	0	*	5	PLC	0	*	6	PLC	0	*	7	PLC	0	*	8	PLC	0	*	9	PLC	0	*	0	PLC	0	*	1	PLC	0	*	2	PLC	0	*	3	PLC	0	*	4	PLC	0	*	5	PLC	0	*	6	PLC	0	*	7	PLC	0	*	8	PLC	0	*	9	PLC	0	*	0	PLC	0	*	1	PLC	0	*	2	PLC	0	*	3	PLC	0	*	4	PLC	0	*	5	PLC	0	*	6	PLC	0	*	7	PLC	0	*	8	PLC	0	*	9	PLC	0	*	0	PLC	0	*	1	PLC	0	*	2	PLC	0	*	3	PLC	0	*	4	PLC	0	*	5	PLC	0	*	6	PLC	0	*	7	PLC	0	*	8	PLC	0	*	9	PLC	0	*	0	PLC	0	*	1	PLC	0	*	2	PLC	0	*	3	PLC	0	*	4	PLC	0	*	5	PLC	0	*	6	PLC	0	*	7	PLC	0	*	8	PLC	0	*	9	PLC	0	*	0	PLC	0	*	1	PLC	0	*	2	PLC	0	*	3	PLC	0	*	4	PLC	0	*	5	PLC	0	*	6	PLC	0	*	7	PLC	0	*	8	PLC	0	*	9	PLC	0	*	0	PLC	0	*	1	PLC	0	*	2	PLC	0	*	3	PLC	0	*	4	PLC	0	*	5	PLC	0	*	6	PLC	0	*	7	PLC	0	*	8	PLC	0	*	9	PLC	0	*	0	PLC	0	*	1	PLC	0	*	2	PLC	0	*	3	PLC	0	*	4	PLC	0	*	5	PLC	0	*	6	PLC	0	*	7	PLC	0	*	8	PLC	0	*	9	PLC	0	*	0	PLC	0	*	1	PLC	0	*	2	PLC	0	*	3	PLC	0	*	4	PLC	0	*	5	PLC	0	*	6	PLC	0	*	7	PLC	0	*	8	PLC	0	*	9	PLC	0	*	0	PLC	0	*	1	PLC	0	*	2	PLC	0	*	3	PLC	0	*	4	PLC	0	*	5	PLC	0	*	6	PLC	0	*	7	PLC	0	*	8	PLC	0	*	9	PLC	0	*	0	PLC	0	*	1	PLC	0	*	2	PLC	0	*	3	PLC	0	*	4	PLC	0	*	5	PLC	0	*	6	PLC	0	*	7	PLC	0	*	8	PLC	0	*	9	PLC	0	*	0	PLC	0	*	1	PLC	0	*	2	PLC	0	*	3	PLC	0	*	4	PLC	0	*	5	PLC	0	*	6	PLC	0	*	7	PLC	0	*	8	PLC	0	*	9	PLC	0	*	0	PLC	0	*	1	PLC	0	*	2	PLC	0	*	3	PLC	0	*	4	PLC	0	*	5	PLC	0	*	6	PLC	0	*	7	PLC	0	*	8	PLC	0	*	9	PLC	0	*	0	PLC	0	*	1	PLC	0	*	2	PLC	0	*	3	PLC	0	*	4	PLC	0	*	5	PLC	0	*	6	PLC	0	*	7	PLC
0	PLC	0	*																																																																																																																																																																																																																																																																																																																																																																																																																																																																																																																																																																																																																																																																																																																																																																																																																																																																																																																																																																																																																																																																																																																																																																																																																																																																																																																																																																																																																																																																																																																																																																																																																																																																																													
1	PLC	0	*																																																																																																																																																																																																																																																																																																																																																																																																																																																																																																																																																																																																																																																																																																																																																																																																																																																																																																																																																																																																																																																																																																																																																																																																																																																																																																																																																																																																																																																																																																																																																																																																																																																																																													
2	PLC	0	*																																																																																																																																																																																																																																																																																																																																																																																																																																																																																																																																																																																																																																																																																																																																																																																																																																																																																																																																																																																																																																																																																																																																																																																																																																																																																																																																																																																																																																																																																																																																																																																																																																																																																													
3	PLC	0	*																																																																																																																																																																																																																																																																																																																																																																																																																																																																																																																																																																																																																																																																																																																																																																																																																																																																																																																																																																																																																																																																																																																																																																																																																																																																																																																																																																																																																																																																																																																																																																																																																																																																																													
4	PLC	0	*																																																																																																																																																																																																																																																																																																																																																																																																																																																																																																																																																																																																																																																																																																																																																																																																																																																																																																																																																																																																																																																																																																																																																																																																																																																																																																																																																																																																																																																																																																																																																																																																																																																																																													
5	PLC	0	*																																																																																																																																																																																																																																																																																																																																																																																																																																																																																																																																																																																																																																																																																																																																																																																																																																																																																																																																																																																																																																																																																																																																																																																																																																																																																																																																																																																																																																																																																																																																																																																																																																																																																													
6	PLC	0	*																																																																																																																																																																																																																																																																																																																																																																																																																																																																																																																																																																																																																																																																																																																																																																																																																																																																																																																																																																																																																																																																																																																																																																																																																																																																																																																																																																																																																																																																																																																																																																																																																																																																																													
7	PLC	0	*																																																																																																																																																																																																																																																																																																																																																																																																																																																																																																																																																																																																																																																																																																																																																																																																																																																																																																																																																																																																																																																																																																																																																																																																																																																																																																																																																																																																																																																																																																																																																																																																																																																																																													
8	PLC	0	*																																																																																																																																																																																																																																																																																																																																																																																																																																																																																																																																																																																																																																																																																																																																																																																																																																																																																																																																																																																																																																																																																																																																																																																																																																																																																																																																																																																																																																																																																																																																																																																																																																																																																													
9	PLC	0	*																																																																																																																																																																																																																																																																																																																																																																																																																																																																																																																																																																																																																																																																																																																																																																																																																																																																																																																																																																																																																																																																																																																																																																																																																																																																																																																																																																																																																																																																																																																																																																																																																																																																																													
0	PLC	0	*																																																																																																																																																																																																																																																																																																																																																																																																																																																																																																																																																																																																																																																																																																																																																																																																																																																																																																																																																																																																																																																																																																																																																																																																																																																																																																																																																																																																																																																																																																																																																																																																																																																																																													
1	PLC	0	*																																																																																																																																																																																																																																																																																																																																																																																																																																																																																																																																																																																																																																																																																																																																																																																																																																																																																																																																																																																																																																																																																																																																																																																																																																																																																																																																																																																																																																																																																																																																																																																																																																																																																													
2	PLC	0	*																																																																																																																																																																																																																																																																																																																																																																																																																																																																																																																																																																																																																																																																																																																																																																																																																																																																																																																																																																																																																																																																																																																																																																																																																																																																																																																																																																																																																																																																																																																																																																																																																																																																																													
3	PLC	0	*																																																																																																																																																																																																																																																																																																																																																																																																																																																																																																																																																																																																																																																																																																																																																																																																																																																																																																																																																																																																																																																																																																																																																																																																																																																																																																																																																																																																																																																																																																																																																																																																																																																																																													
4	PLC	0	*																																																																																																																																																																																																																																																																																																																																																																																																																																																																																																																																																																																																																																																																																																																																																																																																																																																																																																																																																																																																																																																																																																																																																																																																																																																																																																																																																																																																																																																																																																																																																																																																																																																																																													
5	PLC	0	*																																																																																																																																																																																																																																																																																																																																																																																																																																																																																																																																																																																																																																																																																																																																																																																																																																																																																																																																																																																																																																																																																																																																																																																																																																																																																																																																																																																																																																																																																																																																																																																																																																																																																													
6	PLC	0	*																																																																																																																																																																																																																																																																																																																																																																																																																																																																																																																																																																																																																																																																																																																																																																																																																																																																																																																																																																																																																																																																																																																																																																																																																																																																																																																																																																																																																																																																																																																																																																																																																																																																																													
7	PLC	0	*																																																																																																																																																																																																																																																																																																																																																																																																																																																																																																																																																																																																																																																																																																																																																																																																																																																																																																																																																																																																																																																																																																																																																																																																																																																																																																																																																																																																																																																																																																																																																																																																																																																																																													
8	PLC	0	*																																																																																																																																																																																																																																																																																																																																																																																																																																																																																																																																																																																																																																																																																																																																																																																																																																																																																																																																																																																																																																																																																																																																																																																																																																																																																																																																																																																																																																																																																																																																																																																																																																																																																													
9	PLC	0	*																																																																																																																																																																																																																																																																																																																																																																																																																																																																																																																																																																																																																																																																																																																																																																																																																																																																																																																																																																																																																																																																																																																																																																																																																																																																																																																																																																																																																																																																																																																																																																																																																																																																																													
0	PLC	0	*																																																																																																																																																																																																																																																																																																																																																																																																																																																																																																																																																																																																																																																																																																																																																																																																																																																																																																																																																																																																																																																																																																																																																																																																																																																																																																																																																																																																																																																																																																																																																																																																																																																																																													
1	PLC	0	*																																																																																																																																																																																																																																																																																																																																																																																																																																																																																																																																																																																																																																																																																																																																																																																																																																																																																																																																																																																																																																																																																																																																																																																																																																																																																																																																																																																																																																																																																																																																																																																																																																																																																													
2	PLC	0	*																																																																																																																																																																																																																																																																																																																																																																																																																																																																																																																																																																																																																																																																																																																																																																																																																																																																																																																																																																																																																																																																																																																																																																																																																																																																																																																																																																																																																																																																																																																																																																																																																																																																																													
3	PLC	0	*																																																																																																																																																																																																																																																																																																																																																																																																																																																																																																																																																																																																																																																																																																																																																																																																																																																																																																																																																																																																																																																																																																																																																																																																																																																																																																																																																																																																																																																																																																																																																																																																																																																																																													
4	PLC	0	*																																																																																																																																																																																																																																																																																																																																																																																																																																																																																																																																																																																																																																																																																																																																																																																																																																																																																																																																																																																																																																																																																																																																																																																																																																																																																																																																																																																																																																																																																																																																																																																																																																																																																													
5	PLC	0	*																																																																																																																																																																																																																																																																																																																																																																																																																																																																																																																																																																																																																																																																																																																																																																																																																																																																																																																																																																																																																																																																																																																																																																																																																																																																																																																																																																																																																																																																																																																																																																																																																																																																																													
6	PLC	0	*																																																																																																																																																																																																																																																																																																																																																																																																																																																																																																																																																																																																																																																																																																																																																																																																																																																																																																																																																																																																																																																																																																																																																																																																																																																																																																																																																																																																																																																																																																																																																																																																																																																																																													
7	PLC	0	*																																																																																																																																																																																																																																																																																																																																																																																																																																																																																																																																																																																																																																																																																																																																																																																																																																																																																																																																																																																																																																																																																																																																																																																																																																																																																																																																																																																																																																																																																																																																																																																																																																																																																													
8	PLC	0	*																																																																																																																																																																																																																																																																																																																																																																																																																																																																																																																																																																																																																																																																																																																																																																																																																																																																																																																																																																																																																																																																																																																																																																																																																																																																																																																																																																																																																																																																																																																																																																																																																																																																																													
9	PLC	0	*																																																																																																																																																																																																																																																																																																																																																																																																																																																																																																																																																																																																																																																																																																																																																																																																																																																																																																																																																																																																																																																																																																																																																																																																																																																																																																																																																																																																																																																																																																																																																																																																																																																																																													
0	PLC	0	*																																																																																																																																																																																																																																																																																																																																																																																																																																																																																																																																																																																																																																																																																																																																																																																																																																																																																																																																																																																																																																																																																																																																																																																																																																																																																																																																																																																																																																																																																																																																																																																																																																																																																													
1	PLC	0	*																																																																																																																																																																																																																																																																																																																																																																																																																																																																																																																																																																																																																																																																																																																																																																																																																																																																																																																																																																																																																																																																																																																																																																																																																																																																																																																																																																																																																																																																																																																																																																																																																																																																																													
2	PLC	0	*																																																																																																																																																																																																																																																																																																																																																																																																																																																																																																																																																																																																																																																																																																																																																																																																																																																																																																																																																																																																																																																																																																																																																																																																																																																																																																																																																																																																																																																																																																																																																																																																																																																																																													
3	PLC	0	*																																																																																																																																																																																																																																																																																																																																																																																																																																																																																																																																																																																																																																																																																																																																																																																																																																																																																																																																																																																																																																																																																																																																																																																																																																																																																																																																																																																																																																																																																																																																																																																																																																																																																													
4	PLC	0	*																																																																																																																																																																																																																																																																																																																																																																																																																																																																																																																																																																																																																																																																																																																																																																																																																																																																																																																																																																																																																																																																																																																																																																																																																																																																																																																																																																																																																																																																																																																																																																																																																																																																																													
5	PLC	0	*																																																																																																																																																																																																																																																																																																																																																																																																																																																																																																																																																																																																																																																																																																																																																																																																																																																																																																																																																																																																																																																																																																																																																																																																																																																																																																																																																																																																																																																																																																																																																																																																																																																																																													
6	PLC	0	*																																																																																																																																																																																																																																																																																																																																																																																																																																																																																																																																																																																																																																																																																																																																																																																																																																																																																																																																																																																																																																																																																																																																																																																																																																																																																																																																																																																																																																																																																																																																																																																																																																																																																													
7	PLC	0	*																																																																																																																																																																																																																																																																																																																																																																																																																																																																																																																																																																																																																																																																																																																																																																																																																																																																																																																																																																																																																																																																																																																																																																																																																																																																																																																																																																																																																																																																																																																																																																																																																																																																																													
8	PLC	0	*																																																																																																																																																																																																																																																																																																																																																																																																																																																																																																																																																																																																																																																																																																																																																																																																																																																																																																																																																																																																																																																																																																																																																																																																																																																																																																																																																																																																																																																																																																																																																																																																																																																																																													
9	PLC	0	*																																																																																																																																																																																																																																																																																																																																																																																																																																																																																																																																																																																																																																																																																																																																																																																																																																																																																																																																																																																																																																																																																																																																																																																																																																																																																																																																																																																																																																																																																																																																																																																																																																																																																													
0	PLC	0	*																																																																																																																																																																																																																																																																																																																																																																																																																																																																																																																																																																																																																																																																																																																																																																																																																																																																																																																																																																																																																																																																																																																																																																																																																																																																																																																																																																																																																																																																																																																																																																																																																																																																																													
1	PLC	0	*																																																																																																																																																																																																																																																																																																																																																																																																																																																																																																																																																																																																																																																																																																																																																																																																																																																																																																																																																																																																																																																																																																																																																																																																																																																																																																																																																																																																																																																																																																																																																																																																																																																																																													
2	PLC	0	*																																																																																																																																																																																																																																																																																																																																																																																																																																																																																																																																																																																																																																																																																																																																																																																																																																																																																																																																																																																																																																																																																																																																																																																																																																																																																																																																																																																																																																																																																																																																																																																																																																																																																													
3	PLC	0	*																																																																																																																																																																																																																																																																																																																																																																																																																																																																																																																																																																																																																																																																																																																																																																																																																																																																																																																																																																																																																																																																																																																																																																																																																																																																																																																																																																																																																																																																																																																																																																																																																																																																																													
4	PLC	0	*																																																																																																																																																																																																																																																																																																																																																																																																																																																																																																																																																																																																																																																																																																																																																																																																																																																																																																																																																																																																																																																																																																																																																																																																																																																																																																																																																																																																																																																																																																																																																																																																																																																																																													
5	PLC	0	*																																																																																																																																																																																																																																																																																																																																																																																																																																																																																																																																																																																																																																																																																																																																																																																																																																																																																																																																																																																																																																																																																																																																																																																																																																																																																																																																																																																																																																																																																																																																																																																																																																																																																													
6	PLC	0	*																																																																																																																																																																																																																																																																																																																																																																																																																																																																																																																																																																																																																																																																																																																																																																																																																																																																																																																																																																																																																																																																																																																																																																																																																																																																																																																																																																																																																																																																																																																																																																																																																																																																																													
7	PLC	0	*																																																																																																																																																																																																																																																																																																																																																																																																																																																																																																																																																																																																																																																																																																																																																																																																																																																																																																																																																																																																																																																																																																																																																																																																																																																																																																																																																																																																																																																																																																																																																																																																																																																																																													
8	PLC	0	*																																																																																																																																																																																																																																																																																																																																																																																																																																																																																																																																																																																																																																																																																																																																																																																																																																																																																																																																																																																																																																																																																																																																																																																																																																																																																																																																																																																																																																																																																																																																																																																																																																																																																													
9	PLC	0	*																																																																																																																																																																																																																																																																																																																																																																																																																																																																																																																																																																																																																																																																																																																																																																																																																																																																																																																																																																																																																																																																																																																																																																																																																																																																																																																																																																																																																																																																																																																																																																																																																																																																																													
0	PLC	0	*																																																																																																																																																																																																																																																																																																																																																																																																																																																																																																																																																																																																																																																																																																																																																																																																																																																																																																																																																																																																																																																																																																																																																																																																																																																																																																																																																																																																																																																																																																																																																																																																																																																																																													
1	PLC	0	*																																																																																																																																																																																																																																																																																																																																																																																																																																																																																																																																																																																																																																																																																																																																																																																																																																																																																																																																																																																																																																																																																																																																																																																																																																																																																																																																																																																																																																																																																																																																																																																																																																																																																													
2	PLC	0	*																																																																																																																																																																																																																																																																																																																																																																																																																																																																																																																																																																																																																																																																																																																																																																																																																																																																																																																																																																																																																																																																																																																																																																																																																																																																																																																																																																																																																																																																																																																																																																																																																																																																																													
3	PLC	0	*																																																																																																																																																																																																																																																																																																																																																																																																																																																																																																																																																																																																																																																																																																																																																																																																																																																																																																																																																																																																																																																																																																																																																																																																																																																																																																																																																																																																																																																																																																																																																																																																																																																																																													
4	PLC	0	*																																																																																																																																																																																																																																																																																																																																																																																																																																																																																																																																																																																																																																																																																																																																																																																																																																																																																																																																																																																																																																																																																																																																																																																																																																																																																																																																																																																																																																																																																																																																																																																																																																																																																													
5	PLC	0	*																																																																																																																																																																																																																																																																																																																																																																																																																																																																																																																																																																																																																																																																																																																																																																																																																																																																																																																																																																																																																																																																																																																																																																																																																																																																																																																																																																																																																																																																																																																																																																																																																																																																																													
6	PLC	0	*																																																																																																																																																																																																																																																																																																																																																																																																																																																																																																																																																																																																																																																																																																																																																																																																																																																																																																																																																																																																																																																																																																																																																																																																																																																																																																																																																																																																																																																																																																																																																																																																																																																																																													
7	PLC	0	*																																																																																																																																																																																																																																																																																																																																																																																																																																																																																																																																																																																																																																																																																																																																																																																																																																																																																																																																																																																																																																																																																																																																																																																																																																																																																																																																																																																																																																																																																																																																																																																																																																																																																													
8	PLC	0	*																																																																																																																																																																																																																																																																																																																																																																																																																																																																																																																																																																																																																																																																																																																																																																																																																																																																																																																																																																																																																																																																																																																																																																																																																																																																																																																																																																																																																																																																																																																																																																																																																																																																																													
9	PLC	0	*																																																																																																																																																																																																																																																																																																																																																																																																																																																																																																																																																																																																																																																																																																																																																																																																																																																																																																																																																																																																																																																																																																																																																																																																																																																																																																																																																																																																																																																																																																																																																																																																																																																																																													
0	PLC	0	*																																																																																																																																																																																																																																																																																																																																																																																																																																																																																																																																																																																																																																																																																																																																																																																																																																																																																																																																																																																																																																																																																																																																																																																																																																																																																																																																																																																																																																																																																																																																																																																																																																																																																													
1	PLC	0	*																																																																																																																																																																																																																																																																																																																																																																																																																																																																																																																																																																																																																																																																																																																																																																																																																																																																																																																																																																																																																																																																																																																																																																																																																																																																																																																																																																																																																																																																																																																																																																																																																																																																																													
2	PLC	0	*																																																																																																																																																																																																																																																																																																																																																																																																																																																																																																																																																																																																																																																																																																																																																																																																																																																																																																																																																																																																																																																																																																																																																																																																																																																																																																																																																																																																																																																																																																																																																																																																																																																																																													
3	PLC	0	*																																																																																																																																																																																																																																																																																																																																																																																																																																																																																																																																																																																																																																																																																																																																																																																																																																																																																																																																																																																																																																																																																																																																																																																																																																																																																																																																																																																																																																																																																																																																																																																																																																																																																													
4	PLC	0	*																																																																																																																																																																																																																																																																																																																																																																																																																																																																																																																																																																																																																																																																																																																																																																																																																																																																																																																																																																																																																																																																																																																																																																																																																																																																																																																																																																																																																																																																																																																																																																																																																																																																																													
5	PLC	0	*																																																																																																																																																																																																																																																																																																																																																																																																																																																																																																																																																																																																																																																																																																																																																																																																																																																																																																																																																																																																																																																																																																																																																																																																																																																																																																																																																																																																																																																																																																																																																																																																																																																																																													
6	PLC	0	*																																																																																																																																																																																																																																																																																																																																																																																																																																																																																																																																																																																																																																																																																																																																																																																																																																																																																																																																																																																																																																																																																																																																																																																																																																																																																																																																																																																																																																																																																																																																																																																																																																																																																													
7	PLC	0	*																																																																																																																																																																																																																																																																																																																																																																																																																																																																																																																																																																																																																																																																																																																																																																																																																																																																																																																																																																																																																																																																																																																																																																																																																																																																																																																																																																																																																																																																																																																																																																																																																																																																																													
8	PLC	0	*																																																																																																																																																																																																																																																																																																																																																																																																																																																																																																																																																																																																																																																																																																																																																																																																																																																																																																																																																																																																																																																																																																																																																																																																																																																																																																																																																																																																																																																																																																																																																																																																																																																																																													
9	PLC	0	*																																																																																																																																																																																																																																																																																																																																																																																																																																																																																																																																																																																																																																																																																																																																																																																																																																																																																																																																																																																																																																																																																																																																																																																																																																																																																																																																																																																																																																																																																																																																																																																																																																																																																													
0	PLC	0	*																																																																																																																																																																																																																																																																																																																																																																																																																																																																																																																																																																																																																																																																																																																																																																																																																																																																																																																																																																																																																																																																																																																																																																																																																																																																																																																																																																																																																																																																																																																																																																																																																																																																																													
1	PLC	0	*																																																																																																																																																																																																																																																																																																																																																																																																																																																																																																																																																																																																																																																																																																																																																																																																																																																																																																																																																																																																																																																																																																																																																																																																																																																																																																																																																																																																																																																																																																																																																																																																																																																																																													
2	PLC	0	*																																																																																																																																																																																																																																																																																																																																																																																																																																																																																																																																																																																																																																																																																																																																																																																																																																																																																																																																																																																																																																																																																																																																																																																																																																																																																																																																																																																																																																																																																																																																																																																																																																																																																													
3	PLC	0	*																																																																																																																																																																																																																																																																																																																																																																																																																																																																																																																																																																																																																																																																																																																																																																																																																																																																																																																																																																																																																																																																																																																																																																																																																																																																																																																																																																																																																																																																																																																																																																																																																																																																																													
4	PLC	0	*																																																																																																																																																																																																																																																																																																																																																																																																																																																																																																																																																																																																																																																																																																																																																																																																																																																																																																																																																																																																																																																																																																																																																																																																																																																																																																																																																																																																																																																																																																																																																																																																																																																																																													
5	PLC	0	*																																																																																																																																																																																																																																																																																																																																																																																																																																																																																																																																																																																																																																																																																																																																																																																																																																																																																																																																																																																																																																																																																																																																																																																																																																																																																																																																																																																																																																																																																																																																																																																																																																																																																													
6	PLC	0	*																																																																																																																																																																																																																																																																																																																																																																																																																																																																																																																																																																																																																																																																																																																																																																																																																																																																																																																																																																																																																																																																																																																																																																																																																																																																																																																																																																																																																																																																																																																																																																																																																																																																																													
7	PLC	0	*																																																																																																																																																																																																																																																																																																																																																																																																																																																																																																																																																																																																																																																																																																																																																																																																																																																																																																																																																																																																																																																																																																																																																																																																																																																																																																																																																																																																																																																																																																																																																																																																																																																																																													
8	PLC	0	*																																																																																																																																																																																																																																																																																																																																																																																																																																																																																																																																																																																																																																																																																																																																																																																																																																																																																																																																																																																																																																																																																																																																																																																																																																																																																																																																																																																																																																																																																																																																																																																																																																																																																													
9	PLC	0	*																																																																																																																																																																																																																																																																																																																																																																																																																																																																																																																																																																																																																																																																																																																																																																																																																																																																																																																																																																																																																																																																																																																																																																																																																																																																																																																																																																																																																																																																																																																																																																																																																																																																																													
0	PLC	0	*																																																																																																																																																																																																																																																																																																																																																																																																																																																																																																																																																																																																																																																																																																																																																																																																																																																																																																																																																																																																																																																																																																																																																																																																																																																																																																																																																																																																																																																																																																																																																																																																																																																																																													
1	PLC	0	*																																																																																																																																																																																																																																																																																																																																																																																																																																																																																																																																																																																																																																																																																																																																																																																																																																																																																																																																																																																																																																																																																																																																																																																																																																																																																																																																																																																																																																																																																																																																																																																																																																																																																													
2	PLC	0	*																																																																																																																																																																																																																																																																																																																																																																																																																																																																																																																																																																																																																																																																																																																																																																																																																																																																																																																																																																																																																																																																																																																																																																																																																																																																																																																																																																																																																																																																																																																																																																																																																																																																																													
3	PLC	0	*																																																																																																																																																																																																																																																																																																																																																																																																																																																																																																																																																																																																																																																																																																																																																																																																																																																																																																																																																																																																																																																																																																																																																																																																																																																																																																																																																																																																																																																																																																																																																																																																																																																																																													
4	PLC	0	*																																																																																																																																																																																																																																																																																																																																																																																																																																																																																																																																																																																																																																																																																																																																																																																																																																																																																																																																																																																																																																																																																																																																																																																																																																																																																																																																																																																																																																																																																																																																																																																																																																																																																													
5	PLC	0	*																																																																																																																																																																																																																																																																																																																																																																																																																																																																																																																																																																																																																																																																																																																																																																																																																																																																																																																																																																																																																																																																																																																																																																																																																																																																																																																																																																																																																																																																																																																																																																																																																																																																																													
6	PLC	0	*																																																																																																																																																																																																																																																																																																																																																																																																																																																																																																																																																																																																																																																																																																																																																																																																																																																																																																																																																																																																																																																																																																																																																																																																																																																																																																																																																																																																																																																																																																																																																																																																																																																																																													
7	PLC	0	*																																																																																																																																																																																																																																																																																																																																																																																																																																																																																																																																																																																																																																																																																																																																																																																																																																																																																																																																																																																																																																																																																																																																																																																																																																																																																																																																																																																																																																																																																																																																																																																																																																																																																													
8	PLC	0	*																																																																																																																																																																																																																																																																																																																																																																																																																																																																																																																																																																																																																																																																																																																																																																																																																																																																																																																																																																																																																																																																																																																																																																																																																																																																																																																																																																																																																																																																																																																																																																																																																																																																																													
9	PLC	0	*																																																																																																																																																																																																																																																																																																																																																																																																																																																																																																																																																																																																																																																																																																																																																																																																																																																																																																																																																																																																																																																																																																																																																																																																																																																																																																																																																																																																																																																																																																																																																																																																																																																																																													
0	PLC	0	*																																																																																																																																																																																																																																																																																																																																																																																																																																																																																																																																																																																																																																																																																																																																																																																																																																																																																																																																																																																																																																																																																																																																																																																																																																																																																																																																																																																																																																																																																																																																																																																																																																																																																													
1	PLC	0	*																																																																																																																																																																																																																																																																																																																																																																																																																																																																																																																																																																																																																																																																																																																																																																																																																																																																																																																																																																																																																																																																																																																																																																																																																																																																																																																																																																																																																																																																																																																																																																																																																																																																																													
2	PLC	0	*																																																																																																																																																																																																																																																																																																																																																																																																																																																																																																																																																																																																																																																																																																																																																																																																																																																																																																																																																																																																																																																																																																																																																																																																																																																																																																																																																																																																																																																																																																																																																																																																																																																																																													
3	PLC	0	*																																																																																																																																																																																																																																																																																																																																																																																																																																																																																																																																																																																																																																																																																																																																																																																																																																																																																																																																																																																																																																																																																																																																																																																																																																																																																																																																																																																																																																																																																																																																																																																																																																																																																													
4	PLC	0	*																																																																																																																																																																																																																																																																																																																																																																																																																																																																																																																																																																																																																																																																																																																																																																																																																																																																																																																																																																																																																																																																																																																																																																																																																																																																																																																																																																																																																																																																																																																																																																																																																																																																																													
5	PLC	0	*																																																																																																																																																																																																																																																																																																																																																																																																																																																																																																																																																																																																																																																																																																																																																																																																																																																																																																																																																																																																																																																																																																																																																																																																																																																																																																																																																																																																																																																																																																																																																																																																																																																																																													
6	PLC	0	*																																																																																																																																																																																																																																																																																																																																																																																																																																																																																																																																																																																																																																																																																																																																																																																																																																																																																																																																																																																																																																																																																																																																																																																																																																																																																																																																																																																																																																																																																																																																																																																																																																																																																													
7	PLC	0	*																																																																																																																																																																																																																																																																																																																																																																																																																																																																																																																																																																																																																																																																																																																																																																																																																																																																																																																																																																																																																																																																																																																																																																																																																																																																																																																																																																																																																																																																																																																																																																																																																																																																																													
8	PLC	0	*																																																																																																																																																																																																																																																																																																																																																																																																																																																																																																																																																																																																																																																																																																																																																																																																																																																																																																																																																																																																																																																																																																																																																																																																																																																																																																																																																																																																																																																																																																																																																																																																																																																																																													
9	PLC	0	*																																																																																																																																																																																																																																																																																																																																																																																																																																																																																																																																																																																																																																																																																																																																																																																																																																																																																																																																																																																																																																																																																																																																																																																																																																																																																																																																																																																																																																																																																																																																																																																																																																																																																													
0	PLC	0	*																																																																																																																																																																																																																																																																																																																																																																																																																																																																																																																																																																																																																																																																																																																																																																																																																																																																																																																																																																																																																																																																																																																																																																																																																																																																																																																																																																																																																																																																																																																																																																																																																																																																																													
1	PLC	0	*																																																																																																																																																																																																																																																																																																																																																																																																																																																																																																																																																																																																																																																																																																																																																																																																																																																																																																																																																																																																																																																																																																																																																																																																																																																																																																																																																																																																																																																																																																																																																																																																																																																																																													
2	PLC	0	*																																																																																																																																																																																																																																																																																																																																																																																																																																																																																																																																																																																																																																																																																																																																																																																																																																																																																																																																																																																																																																																																																																																																																																																																																																																																																																																																																																																																																																																																																																																																																																																																																																																																																													
3	PLC	0	*																																																																																																																																																																																																																																																																																																																																																																																																																																																																																																																																																																																																																																																																																																																																																																																																																																																																																																																																																																																																																																																																																																																																																																																																																																																																																																																																																																																																																																																																																																																																																																																																																																																																																													
4	PLC	0	*																																																																																																																																																																																																																																																																																																																																																																																																																																																																																																																																																																																																																																																																																																																																																																																																																																																																																																																																																																																																																																																																																																																																																																																																																																																																																																																																																																																																																																																																																																																																																																																																																																																																																													
5	PLC	0	*																																																																																																																																																																																																																																																																																																																																																																																																																																																																																																																																																																																																																																																																																																																																																																																																																																																																																																																																																																																																																																																																																																																																																																																																																																																																																																																																																																																																																																																																																																																																																																																																																																																																																													
6	PLC	0	*																																																																																																																																																																																																																																																																																																																																																																																																																																																																																																																																																																																																																																																																																																																																																																																																																																																																																																																																																																																																																																																																																																																																																																																																																																																																																																																																																																																																																																																																																																																																																																																																																																																																																													
7	PLC	0	*																																																																																																																																																																																																																																																																																																																																																																																																																																																																																																																																																																																																																																																																																																																																																																																																																																																																																																																																																																																																																																																																																																																																																																																																																																																																																																																																																																																																																																																																																																																																																																																																																																																																																													
8	PLC	0	*																																																																																																																																																																																																																																																																																																																																																																																																																																																																																																																																																																																																																																																																																																																																																																																																																																																																																																																																																																																																																																																																																																																																																																																																																																																																																																																																																																																																																																																																																																																																																																																																																																																																																													
9	PLC	0	*																																																																																																																																																																																																																																																																																																																																																																																																																																																																																																																																																																																																																																																																																																																																																																																																																																																																																																																																																																																																																																																																																																																																																																																																																																																																																																																																																																																																																																																																																																																																																																																																																																																																																													
0	PLC	0	*																																																																																																																																																																																																																																																																																																																																																																																																																																																																																																																																																																																																																																																																																																																																																																																																																																																																																																																																																																																																																																																																																																																																																																																																																																																																																																																																																																																																																																																																																																																																																																																																																																																																																													
1	PLC	0	*																																																																																																																																																																																																																																																																																																																																																																																																																																																																																																																																																																																																																																																																																																																																																																																																																																																																																																																																																																																																																																																																																																																																																																																																																																																																																																																																																																																																																																																																																																																																																																																																																																																																																													
2	PLC	0	*																																																																																																																																																																																																																																																																																																																																																																																																																																																																																																																																																																																																																																																																																																																																																																																																																																																																																																																																																																																																																																																																																																																																																																																																																																																																																																																																																																																																																																																																																																																																																																																																																																																																																													
3	PLC	0	*																																																																																																																																																																																																																																																																																																																																																																																																																																																																																																																																																																																																																																																																																																																																																																																																																																																																																																																																																																																																																																																																																																																																																																																																																																																																																																																																																																																																																																																																																																																																																																																																																																																																																													
4	PLC	0	*																																																																																																																																																																																																																																																																																																																																																																																																																																																																																																																																																																																																																																																																																																																																																																																																																																																																																																																																																																																																																																																																																																																																																																																																																																																																																																																																																																																																																																																																																																																																																																																																																																																																																													
5	PLC	0	*																																																																																																																																																																																																																																																																																																																																																																																																																																																																																																																																																																																																																																																																																																																																																																																																																																																																																																																																																																																																																																																																																																																																																																																																																																																																																																																																																																																																																																																																																																																																																																																																																																																																																													
6	PLC	0	*																																																																																																																																																																																																																																																																																																																																																																																																																																																																																																																																																																																																																																																																																																																																																																																																																																																																																																																																																																																																																																																																																																																																																																																																																																																																																																																																																																																																																																																																																																																																																																																																																																																																																													
7	PLC	0	*																																																																																																																																																																																																																																																																																																																																																																																																																																																																																																																																																																																																																																																																																																																																																																																																																																																																																																																																																																																																																																																																																																																																																																																																																																																																																																																																																																																																																																																																																																																																																																																																																																																																																													
8	PLC	0	*																																																																																																																																																																																																																																																																																																																																																																																																																																																																																																																																																																																																																																																																																																																																																																																																																																																																																																																																																																																																																																																																																																																																																																																																																																																																																																																																																																																																																																																																																																																																																																																																																																																																																													
9	PLC	0	*																																																																																																																																																																																																																																																																																																																																																																																																																																																																																																																																																																																																																																																																																																																																																																																																																																																																																																																																																																																																																																																																																																																																																																																																																																																																																																																																																																																																																																																																																																																																																																																																																																																																																													
0	PLC	0	*																																																																																																																																																																																																																																																																																																																																																																																																																																																																																																																																																																																																																																																																																																																																																																																																																																																																																																																																																																																																																																																																																																																																																																																																																																																																																																																																																																																																																																																																																																																																																																																																																																																																																													
1	PLC	0	*																																																																																																																																																																																																																																																																																																																																																																																																																																																																																																																																																																																																																																																																																																																																																																																																																																																																																																																																																																																																																																																																																																																																																																																																																																																																																																																																																																																																																																																																																																																																																																																																																																																																																													
2	PLC	0	*																																																																																																																																																																																																																																																																																																																																																																																																																																																																																																																																																																																																																																																																																																																																																																																																																																																																																																																																																																																																																																																																																																																																																																																																																																																																																																																																																																																																																																																																																																																																																																																																																																																																																													
3	PLC	0	*																																																																																																																																																																																																																																																																																																																																																																																																																																																																																																																																																																																																																																																																																																																																																																																																																																																																																																																																																																																																																																																																																																																																																																																																																																																																																																																																																																																																																																																																																																																																																																																																																																																																																													
4	PLC	0	*																																																																																																																																																																																																																																																																																																																																																																																																																																																																																																																																																																																																																																																																																																																																																																																																																																																																																																																																																																																																																																																																																																																																																																																																																																																																																																																																																																																																																																																																																																																																																																																																																																																																																													
5	PLC	0	*																																																																																																																																																																																																																																																																																																																																																																																																																																																																																																																																																																																																																																																																																																																																																																																																																																																																																																																																																																																																																																																																																																																																																																																																																																																																																																																																																																																																																																																																																																																																																																																																																																																																																													
6	PLC	0	*																																																																																																																																																																																																																																																																																																																																																																																																																																																																																																																																																																																																																																																																																																																																																																																																																																																																																																																																																																																																																																																																																																																																																																																																																																																																																																																																																																																																																																																																																																																																																																																																																																																																																													
7	PLC	0	*																																																																																																																																																																																																																																																																																																																																																																																																																																																																																																																																																																																																																																																																																																																																																																																																																																																																																																																																																																																																																																																																																																																																																																																																																																																																																																																																																																																																																																																																																																																																																																																																																																																																																													
8	PLC	0	*																																																																																																																																																																																																																																																																																																																																																																																																																																																																																																																																																																																																																																																																																																																																																																																																																																																																																																																																																																																																																																																																																																																																																																																																																																																																																																																																																																																																																																																																																																																																																																																																																																																																																													
9	PLC	0	*																																																																																																																																																																																																																																																																																																																																																																																																																																																																																																																																																																																																																																																																																																																																																																																																																																																																																																																																																																																																																																																																																																																																																																																																																																																																																																																																																																																																																																																																																																																																																																																																																																																																																													
0	PLC	0	*																																																																																																																																																																																																																																																																																																																																																																																																																																																																																																																																																																																																																																																																																																																																																																																																																																																																																																																																																																																																																																																																																																																																																																																																																																																																																																																																																																																																																																																																																																																																																																																																																																																																																													
1	PLC	0	*																																																																																																																																																																																																																																																																																																																																																																																																																																																																																																																																																																																																																																																																																																																																																																																																																																																																																																																																																																																																																																																																																																																																																																																																																																																																																																																																																																																																																																																																																																																																																																																																																																																																																													
2	PLC	0	*																																																																																																																																																																																																																																																																																																																																																																																																																																																																																																																																																																																																																																																																																																																																																																																																																																																																																																																																																																																																																																																																																																																																																																																																																																																																																																																																																																																																																																																																																																																																																																																																																																																																																													
3	PLC	0	*																																																																																																																																																																																																																																																																																																																																																																																																																																																																																																																																																																																																																																																																																																																																																																																																																																																																																																																																																																																																																																																																																																																																																																																																																																																																																																																																																																																																																																																																																																																																																																																																																																																																																													
4	PLC	0	*																																																																																																																																																																																																																																																																																																																																																																																																																																																																																																																																																																																																																																																																																																																																																																																																																																																																																																																																																																																																																																																																																																																																																																																																																																																																																																																																																																																																																																																																																																																																																																																																																																																																																													
5	PLC	0	*																																																																																																																																																																																																																																																																																																																																																																																																																																																																																																																																																																																																																																																																																																																																																																																																																																																																																																																																																																																																																																																																																																																																																																																																																																																																																																																																																																																																																																																																																																																																																																																																																																																																																													
6	PLC	0	*																																																																																																																																																																																																																																																																																																																																																																																																																																																																																																																																																																																																																																																																																																																																																																																																																																																																																																																																																																																																																																																																																																																																																																																																																																																																																																																																																																																																																																																																																																																																																																																																																																																																																													
7	PLC	0	*																																																																																																																																																																																																																																																																																																																																																																																																																																																																																																																																																																																																																																																																																																																																																																																																																																																																																																																																																																																																																																																																																																																																																																																																																																																																																																																																																																																																																																																																																																																																																																																																																																																																																													
8	PLC	0	*																																																																																																																																																																																																																																																																																																																																																																																																																																																																																																																																																																																																																																																																																																																																																																																																																																																																																																																																																																																																																																																																																																																																																																																																																																																																																																																																																																																																																																																																																																																																																																																																																																																																																													
9	PLC	0	*																																																																																																																																																																																																																																																																																																																																																																																																																																																																																																																																																																																																																																																																																																																																																																																																																																																																																																																																																																																																																																																																																																																																																																																																																																																																																																																																																																																																																																																																																																																																																																																																																																																																																													
0	PLC	0	*																																																																																																																																																																																																																																																																																																																																																																																																																																																																																																																																																																																																																																																																																																																																																																																																																																																																																																																																																																																																																																																																																																																																																																																																																																																																																																																																																																																																																																																																																																																																																																																																																																																																																													
1	PLC	0	*																																																																																																																																																																																																																																																																																																																																																																																																																																																																																																																																																																																																																																																																																																																																																																																																																																																																																																																																																																																																																																																																																																																																																																																																																																																																																																																																																																																																																																																																																																																																																																																																																																																																																													
2	PLC	0	*																																																																																																																																																																																																																																																																																																																																																																																																																																																																																																																																																																																																																																																																																																																																																																																																																																																																																																																																																																																																																																																																																																																																																																																																																																																																																																																																																																																																																																																																																																																																																																																																																																																																																													
3	PLC	0	*																																																																																																																																																																																																																																																																																																																																																																																																																																																																																																																																																																																																																																																																																																																																																																																																																																																																																																																																																																																																																																																																																																																																																																																																																																																																																																																																																																																																																																																																																																																																																																																																																																																																																													
4	PLC	0	*																																																																																																																																																																																																																																																																																																																																																																																																																																																																																																																																																																																																																																																																																																																																																																																																																																																																																																																																																																																																																																																																																																																																																																																																																																																																																																																																																																																																																																																																																																																																																																																																																																																																																													
5	PLC	0	*																																																																																																																																																																																																																																																																																																																																																																																																																																																																																																																																																																																																																																																																																																																																																																																																																																																																																																																																																																																																																																																																																																																																																																																																																																																																																																																																																																																																																																																																																																																																																																																																																																																																																													
6	PLC	0	*																																																																																																																																																																																																																																																																																																																																																																																																																																																																																																																																																																																																																																																																																																																																																																																																																																																																																																																																																																																																																																																																																																																																																																																																																																																																																																																																																																																																																																																																																																																																																																																																																																																																																													
7	PLC	0	*																																																																																																																																																																																																																																																																																																																																																																																																																																																																																																																																																																																																																																																																																																																																																																																																																																																																																																																																																																																																																																																																																																																																																																																																																																																																																																																																																																																																																																																																																																																																																																																																																																																																																													
8	PLC	0	*																																																																																																																																																																																																																																																																																																																																																																																																																																																																																																																																																																																																																																																																																																																																																																																																																																																																																																																																																																																																																																																																																																																																																																																																																																																																																																																																																																																																																																																																																																																																																																																																																																																																																													
9	PLC	0	*																																																																																																																																																																																																																																																																																																																																																																																																																																																																																																																																																																																																																																																																																																																																																																																																																																																																																																																																																																																																																																																																																																																																																																																																																																																																																																																																																																																																																																																																																																																																																																																																																																																																																													
0	PLC	0	*																																																																																																																																																																																																																																																																																																																																																																																																																																																																																																																																																																																																																																																																																																																																																																																																																																																																																																																																																																																																																																																																																																																																																																																																																																																																																																																																																																																																																																																																																																																																																																																																																																																																																													
1	PLC	0	*																																																																																																																																																																																																																																																																																																																																																																																																																																																																																																																																																																																																																																																																																																																																																																																																																																																																																																																																																																																																																																																																																																																																																																																																																																																																																																																																																																																																																																																																																																																																																																																																																																																																																													
2	PLC	0	*																																																																																																																																																																																																																																																																																																																																																																																																																																																																																																																																																																																																																																																																																																																																																																																																																																																																																																																																																																																																																																																																																																																																																																																																																																																																																																																																																																																																																																																																																																																																																																																																																																																																																													
3	PLC	0	*																																																																																																																																																																																																																																																																																																																																																																																																																																																																																																																																																																																																																																																																																																																																																																																																																																																																																																																																																																																																																																																																																																																																																																																																																																																																																																																																																																																																																																																																																																																																																																																																																																																																																													
4	PLC	0	*																																																																																																																																																																																																																																																																																																																																																																																																																																																																																																																																																																																																																																																																																																																																																																																																																																																																																																																																																																																																																																																																																																																																																																																																																																																																																																																																																																																																																																																																																																																																																																																																																																																																																													
5	PLC	0	*																																																																																																																																																																																																																																																																																																																																																																																																																																																																																																																																																																																																																																																																																																																																																																																																																																																																																																																																																																																																																																																																																																																																																																																																																																																																																																																																																																																																																																																																																																																																																																																																																																																																																													
6	PLC	0	*																																																																																																																																																																																																																																																																																																																																																																																																																																																																																																																																																																																																																																																																																																																																																																																																																																																																																																																																																																																																																																																																																																																																																																																																																																																																																																																																																																																																																																																																																																																																																																																																																																																																																													
7	PLC	0	*																																																																																																																																																																																																																																																																																																																																																																																																																																																																																																																																																																																																																																																																																																																																																																																																																																																																																																																																																																																																																																																																																																																																																																																																																																																																																																																																																																																																																																																																																																																																																																																																																																																																																													
8	PLC	0	*																																																																																																																																																																																																																																																																																																																																																																																																																																																																																																																																																																																																																																																																																																																																																																																																																																																																																																																																																																																																																																																																																																																																																																																																																																																																																																																																																																																																																																																																																																																																																																																																																																																																																													
9	PLC	0	*																																																																																																																																																																																																																																																																																																																																																																																																																																																																																																																																																																																																																																																																																																																																																																																																																																																																																																																																																																																																																																																																																																																																																																																																																																																																																																																																																																																																																																																																																																																																																																																																																																																																																													
0	PLC	0	*																																																																																																																																																																																																																																																																																																																																																																																																																																																																																																																																																																																																																																																																																																																																																																																																																																																																																																																																																																																																																																																																																																																																																																																																																																																																																																																																																																																																																																																																																																																																																																																																																																																																																													
1	PLC	0	*																																																																																																																																																																																																																																																																																																																																																																																																																																																																																																																																																																																																																																																																																																																																																																																																																																																																																																																																																																																																																																																																																																																																																																																																																																																																																																																																																																																																																																																																																																																																																																																																																																																																																													
2	PLC	0	*																																																																																																																																																																																																																																																																																																																																																																																																																																																																																																																																																																																																																																																																																																																																																																																																																																																																																																																																																																																																																																																																																																																																																																																																																																																																																																																																																																																																																																																																																																																																																																																																																																																																																													
3	PLC	0	*																																																																																																																																																																																																																																																																																																																																																																																																																																																																																																																																																																																																																																																																																																																																																																																																																																																																																																																																																																																																																																																																																																																																																																																																																																																																																																																																																																																																																																																																																																																																																																																																																																																																																													
4	PLC	0	*																																																																																																																																																																																																																																																																																																																																																																																																																																																																																																																																																																																																																																																																																																																																																																																																																																																																																																																																																																																																																																																																																																																																																																																																																																																																																																																																																																																																																																																																																																																																																																																																																																																																																													
5	PLC	0	*																																																																																																																																																																																																																																																																																																																																																																																																																																																																																																																																																																																																																																																																																																																																																																																																																																																																																																																																																																																																																																																																																																																																																																																																																																																																																																																																																																																																																																																																																																																																																																																																																																																																																													
6	PLC	0	*																																																																																																																																																																																																																																																																																																																																																																																																																																																																																																																																																																																																																																																																																																																																																																																																																																																																																																																																																																																																																																																																																																																																																																																																																																																																																																																																																																																																																																																																																																																																																																																																																																																																																													
7	PLC	0	*																																																																																																																																																																																																																																																																																																																																																																																																																																																																																																																																																																																																																																																																																																																																																																																																																																																																																																																																																																																																																																																																																																																																																																																																																																																																																																																																																																																																																																																																																																																																																																																																																																																																																													
8	PLC	0	*																																																																																																																																																																																																																																																																																																																																																																																																																																																																																																																																																																																																																																																																																																																																																																																																																																																																																																																																																																																																																																																																																																																																																																																																																																																																																																																																																																																																																																																																																																																																																																																																																																																																																													
9	PLC	0	*																																																																																																																																																																																																																																																																																																																																																																																																																																																																																																																																																																																																																																																																																																																																																																																																																																																																																																																																																																																																																																																																																																																																																																																																																																																																																																																																																																																																																																																																																																																																																																																																																																																																																													
0	PLC	0	*																																																																																																																																																																																																																																																																																																																																																																																																																																																																																																																																																																																																																																																																																																																																																																																																																																																																																																																																																																																																																																																																																																																																																																																																																																																																																																																																																																																																																																																																																																																																																																																																																																																																																													
1	PLC	0	*																																																																																																																																																																																																																																																																																																																																																																																																																																																																																																																																																																																																																																																																																																																																																																																																																																																																																																																																																																																																																																																																																																																																																																																																																																																																																																																																																																																																																																																																																																																																																																																																																																																																																													
2	PLC	0	*																																																																																																																																																																																																																																																																																																																																																																																																																																																																																																																																																																																																																																																																																																																																																																																																																																																																																																																																																																																																																																																																																																																																																																																																																																																																																																																																																																																																																																																																																																																																																																																																																																																																																													
3	PLC	0	*																																																																																																																																																																																																																																																																																																																																																																																																																																																																																																																																																																																																																																																																																																																																																																																																																																																																																																																																																																																																																																																																																																																																																																																																																																																																																																																																																																																																																																																																																																																																																																																																																																																																																													
4	PLC	0	*																																																																																																																																																																																																																																																																																																																																																																																																																																																																																																																																																																																																																																																																																																																																																																																																																																																																																																																																																																																																																																																																																																																																																																																																																																																																																																																																																																																																																																																																																																																																																																																																																																																																																													
5	PLC	0	*																																																																																																																																																																																																																																																																																																																																																																																																																																																																																																																																																																																																																																																																																																																																																																																																																																																																																																																																																																																																																																																																																																																																																																																																																																																																																																																																																																																																																																																																																																																																																																																																																																																																																													
6	PLC	0	*																																																																																																																																																																																																																																																																																																																																																																																																																																																																																																																																																																																																																																																																																																																																																																																																																																																																																																																																																																																																																																																																																																																																																																																																																																																																																																																																																																																																																																																																																																																																																																																																																																																																																													
7	PLC	0	*																																																																																																																																																																																																																																																																																																																																																																																																																																																																																																																																																																																																																																																																																																																																																																																																																																																																																																																																																																																																																																																																																																																																																																																																																																																																																																																																																																																																																																																																																																																																																																																																																																																																																													
8	PLC	0	*																																																																																																																																																																																																																																																																																																																																																																																																																																																																																																																																																																																																																																																																																																																																																																																																																																																																																																																																																																																																																																																																																																																																																																																																																																																																																																																																																																																																																																																																																																																																																																																																																																																																																													
9	PLC	0	*																																																																																																																																																																																																																																																																																																																																																																																																																																																																																																																																																																																																																																																																																																																																																																																																																																																																																																																																																																																																																																																																																																																																																																																																																																																																																																																																																																																																																																																																																																																																																																																																																																																																																													
0	PLC	0	*																																																																																																																																																																																																																																																																																																																																																																																																																																																																																																																																																																																																																																																																																																																																																																																																																																																																																																																																																																																																																																																																																																																																																																																																																																																																																																																																																																																																																																																																																																																																																																																																																																																																																													
1	PLC	0	*																																																																																																																																																																																																																																																																																																																																																																																																																																																																																																																																																																																																																																																																																																																																																																																																																																																																																																																																																																																																																																																																																																																																																																																																																																																																																																																																																																																																																																																																																																																																																																																																																																																																																													
2	PLC	0	*																																																																																																																																																																																																																																																																																																																																																																																																																																																																																																																																																																																																																																																																																																																																																																																																																																																																																																																																																																																																																																																																																																																																																																																																																																																																																																																																																																																																																																																																																																																																																																																																																																																																																													
3	PLC	0	*																																																																																																																																																																																																																																																																																																																																																																																																																																																																																																																																																																																																																																																																																																																																																																																																																																																																																																																																																																																																																																																																																																																																																																																																																																																																																																																																																																																																																																																																																																																																																																																																																																																																																													
4	PLC	0	*																																																																																																																																																																																																																																																																																																																																																																																																																																																																																																																																																																																																																																																																																																																																																																																																																																																																																																																																																																																																																																																																																																																																																																																																																																																																																																																																																																																																																																																																																																																																																																																																																																																																																													
5	PLC	0	*																																																																																																																																																																																																																																																																																																																																																																																																																																																																																																																																																																																																																																																																																																																																																																																																																																																																																																																																																																																																																																																																																																																																																																																																																																																																																																																																																																																																																																																																																																																																																																																																																																																																																													
6	PLC	0	*																																																																																																																																																																																																																																																																																																																																																																																																																																																																																																																																																																																																																																																																																																																																																																																																																																																																																																																																																																																																																																																																																																																																																																																																																																																																																																																																																																																																																																																																																																																																																																																																																																																																																													
7	PLC	0	*																																																																																																																																																																																																																																																																																																																																																																																																																																																																																																																																																																																																																																																																																																																																																																																																																																																																																																																																																																																																																																																																																																																																																																																																																																																																																																																																																																																																																																																																																																																																																																																																																																																																																													
8	PLC	0	*																																																																																																																																																																																																																																																																																																																																																																																																																																																																																																																																																																																																																																																																																																																																																																																																																																																																																																																																																																																																																																																																																																																																																																																																																																																																																																																																																																																																																																																																																																																																																																																																																																																																																													
9	PLC	0	*																																																																																																																																																																																																																																																																																																																																																																																																																																																																																																																																																																																																																																																																																																																																																																																																																																																																																																																																																																																																																																																																																																																																																																																																																																																																																																																																																																																																																																																																																																																																																																																																																																																																																													
0	PLC	0	*																																																																																																																																																																																																																																																																																																																																																																																																																																																																																																																																																																																																																																																																																																																																																																																																																																																																																																																																																																																																																																																																																																																																																																																																																																																																																																																																																																																																																																																																																																																																																																																																																																																																																													
1	PLC	0	*																																																																																																																																																																																																																																																																																																																																																																																																																																																																																																																																																																																																																																																																																																																																																																																																																																																																																																																																																																																																																																																																																																																																																																																																																																																																																																																																																																																																																																																																																																																																																																																																																																																																																													
2	PLC	0	*																																																																																																																																																																																																																																																																																																																																																																																																																																																																																																																																																																																																																																																																																																																																																																																																																																																																																																																																																																																																																																																																																																																																																																																																																																																																																																																																																																																																																																																																																																																																																																																																																																																																																													
3	PLC	0	*																																																																																																																																																																																																																																																																																																																																																																																																																																																																																																																																																																																																																																																																																																																																																																																																																																																																																																																																																																																																																																																																																																																																																																																																																																																																																																																																																																																																																																																																																																																																																																																																																																																																																													
4	PLC	0	*																																																																																																																																																																																																																																																																																																																																																																																																																																																																																																																																																																																																																																																																																																																																																																																																																																																																																																																																																																																																																																																																																																																																																																																																																																																																																																																																																																																																																																																																																																																																																																																																																																																																																													
5	PLC	0	*																																																																																																																																																																																																																																																																																																																																																																																																																																																																																																																																																																																																																																																																																																																																																																																																																																																																																																																																																																																																																																																																																																																																																																																																																																																																																																																																																																																																																																																																																																																																																																																																																																																																																													
6	PLC	0	*																																																																																																																																																																																																																																																																																																																																																																																																																																																																																																																																																																																																																																																																																																																																																																																																																																																																																																																																																																																																																																																																																																																																																																																																																																																																																																																																																																																																																																																																																																																																																																																																																																																																																													
7	PLC	0	*																																																																																																																																																																																																																																																																																																																																																																																																																																																																																																																																																																																																																																																																																																																																																																																																																																																																																																																																																																																																																																																																																																																																																																																																																																																																																																																																																																																																																																																																																																																																																																																																																																																																																													
8	PLC	0	*																																																																																																																																																																																																																																																																																																																																																																																																																																																																																																																																																																																																																																																																																																																																																																																																																																																																																																																																																																																																																																																																																																																																																																																																																																																																																																																																																																																																																																																																																																																																																																																																																																																																																													
9	PLC	0	*																																																																																																																																																																																																																																																																																																																																																																																																																																																																																																																																																																																																																																																																																																																																																																																																																																																																																																																																																																																																																																																																																																																																																																																																																																																																																																																																																																																																																																																																																																																																																																																																																																																																																													
0	PLC	0	*																																																																																																																																																																																																																																																																																																																																																																																																																																																																																																																																																																																																																																																																																																																																																																																																																																																																																																																																																																																																																																																																																																																																																																																																																																																																																																																																																																																																																																																																																																																																																																																																																																																																																													
1	PLC	0	*																																																																																																																																																																																																																																																																																																																																																																																																																																																																																																																																																																																																																																																																																																																																																																																																																																																																																																																																																																																																																																																																																																																																																																																																																																																																																																																																																																																																																																																																																																																																																																																																																																																																																													
2	PLC	0	*																																																																																																																																																																																																																																																																																																																																																																																																																																																																																																																																																																																																																																																																																																																																																																																																																																																																																																																																																																																																																																																																																																																																																																																																																																																																																																																																																																																																																																																																																																																																																																																																																																																																																													
3	PLC	0	*																																																																																																																																																																																																																																																																																																																																																																																																																																																																																																																																																																																																																																																																																																																																																																																																																																																																																																																																																																																																																																																																																																																																																																																																																																																																																																																																																																																																																																																																																																																																																																																																																																																																																													
4	PLC	0	*																																																																																																																																																																																																																																																																																																																																																																																																																																																																																																																																																																																																																																																																																																																																																																																																																																																																																																																																																																																																																																																																																																																																																																																																																																																																																																																																																																																																																																																																																																																																																																																																																																																																																													
5	PLC	0	*																																																																																																																																																																																																																																																																																																																																																																																																																																																																																																																																																																																																																																																																																																																																																																																																																																																																																																																																																																																																																																																																																																																																																																																																																																																																																																																																																																																																																																																																																																																																																																																																																																																																																													
6	PLC	0	*																																																																																																																																																																																																																																																																																																																																																																																																																																																																																																																																																																																																																																																																																																																																																																																																																																																																																																																																																																																																																																																																																																																																																																																																																																																																																																																																																																																																																																																																																																																																																																																																																																																																																													
7	PLC	0	*																																																																																																																																																																																																																																																																																																																																																																																																																																																																																																																																																																																																																																																																																																																																																																																																																																																																																																																																																																																																																																																																																																																																																																																																																																																																																																																																																																																																																																																																																																																																																																																																																																																																																													
8	PLC	0	*																																																																																																																																																																																																																																																																																																																																																																																																																																																																																																																																																																																																																																																																																																																																																																																																																																																																																																																																																																																																																																																																																																																																																																																																																																																																																																																																																																																																																																																																																																																																																																																																																																																																																													
9	PLC	0	*																																																																																																																																																																																																																																																																																																																																																																																																																																																																																																																																																																																																																																																																																																																																																																																																																																																																																																																																																																																																																																																																																																																																																																																																																																																																																																																																																																																																																																																																																																																																																																																																																																																																																													
0	PLC	0	*																																																																																																																																																																																																																																																																																																																																																																																																																																																																																																																																																																																																																																																																																																																																																																																																																																																																																																																																																																																																																																																																																																																																																																																																																																																																																																																																																																																																																																																																																																																																																																																																																																																																																													
1	PLC	0	*																																																																																																																																																																																																																																																																																																																																																																																																																																																																																																																																																																																																																																																																																																																																																																																																																																																																																																																																																																																																																																																																																																																																																																																																																																																																																																																																																																																																																																																																																																																																																																																																																																																																																													
2	PLC	0	*																																																																																																																																																																																																																																																																																																																																																																																																																																																																																																																																																																																																																																																																																																																																																																																																																																																																																																																																																																																																																																																																																																																																																																																																																																																																																																																																																																																																																																																																																																																																																																																																																																																																																													
3	PLC	0	*																																																																																																																																																																																																																																																																																																																																																																																																																																																																																																																																																																																																																																																																																																																																																																																																																																																																																																																																																																																																																																																																																																																																																																																																																																																																																																																																																																																																																																																																																																																																																																																																																																																																																													
4	PLC	0	*																																																																																																																																																																																																																																																																																																																																																																																																																																																																																																																																																																																																																																																																																																																																																																																																																																																																																																																																																																																																																																																																																																																																																																																																																																																																																																																																																																																																																																																																																																																																																																																																																																																																																													
5	PLC	0	*																																																																																																																																																																																																																																																																																																																																																																																																																																																																																																																																																																																																																																																																																																																																																																																																																																																																																																																																																																																																																																																																																																																																																																																																																																																																																																																																																																																																																																																																																																																																																																																																																																																																																													
6	PLC	0	*																																																																																																																																																																																																																																																																																																																																																																																																																																																																																																																																																																																																																																																																																																																																																																																																																																																																																																																																																																																																																																																																																																																																																																																																																																																																																																																																																																																																																																																																																																																																																																																																																																																																																													
7	PLC	0	*																																																																																																																																																																																																																																																																																																																																																																																																																																																																																																																																																																																																																																																																																																																																																																																																																																																																																																																																																																																																																																																																																																																																																																																																																																																																																																																																																																																																																																																																																																																																																																																																																																																																																													
8	PLC	0	*																																																																																																																																																																																																																																																																																																																																																																																																																																																																																																																																																																																																																																																																																																																																																																																																																																																																																																																																																																																																																																																																																																																																																																																																																																																																																																																																																																																																																																																																																																																																																																																																																																																																																													
9	PLC	0	*																																																																																																																																																																																																																																																																																																																																																																																																																																																																																																																																																																																																																																																																																																																																																																																																																																																																																																																																																																																																																																																																																																																																																																																																																																																																																																																																																																																																																																																																																																																																																																																																																																																																																													
0	PLC	0	*																																																																																																																																																																																																																																																																																																																																																																																																																																																																																																																																																																																																																																																																																																																																																																																																																																																																																																																																																																																																																																																																																																																																																																																																																																																																																																																																																																																																																																																																																																																																																																																																																																																																																													
1	PLC	0	*																																																																																																																																																																																																																																																																																																																																																																																																																																																																																																																																																																																																																																																																																																																																																																																																																																																																																																																																																																																																																																																																																																																																																																																																																																																																																																																																																																																																																																																																																																																																																																																																																																																																																													
2	PLC	0	*																																																																																																																																																																																																																																																																																																																																																																																																																																																																																																																																																																																																																																																																																																																																																																																																																																																																																																																																																																																																																																																																																																																																																																																																																																																																																																																																																																																																																																																																																																																																																																																																																																																																																													
3	PLC	0	*																																																																																																																																																																																																																																																																																																																																																																																																																																																																																																																																																																																																																																																																																																																																																																																																																																																																																																																																																																																																																																																																																																																																																																																																																																																																																																																																																																																																																																																																																																																																																																																																																																																																																													
4	PLC	0	*																																																																																																																																																																																																																																																																																																																																																																																																																																																																																																																																																																																																																																																																																																																																																																																																																																																																																																																																																																																																																																																																																																																																																																																																																																																																																																																																																																																																																																																																																																																																																																																																																																																																																													
5	PLC	0	*																																																																																																																																																																																																																																																																																																																																																																																																																																																																																																																																																																																																																																																																																																																																																																																																																																																																																																																																																																																																																																																																																																																																																																																																																																																																																																																																																																																																																																																																																																																																																																																																																																																																																													
6	PLC	0	*																																																																																																																																																																																																																																																																																																																																																																																																																																																																																																																																																																																																																																																																																																																																																																																																																																																																																																																																																																																																																																																																																																																																																																																																																																																																																																																																																																																																																																																																																																																																																																																																																																																																																													
7	PLC	0	*																																																																																																																																																																																																																																																																																																																																																																																																																																																																																																																																																																																																																																																																																																																																																																																																																																																																																																																																																																																																																																																																																																																																																																																																																																																																																																																																																																																																																																																																																																																																																																																																																																																																																													
8	PLC	0	*																																																																																																																																																																																																																																																																																																																																																																																																																																																																																																																																																																																																																																																																																																																																																																																																																																																																																																																																																																																																																																																																																																																																																																																																																																																																																																																																																																																																																																																																																																																																																																																																																																																																																													
9	PLC	0	*																																																																																																																																																																																																																																																																																																																																																																																																																																																																																																																																																																																																																																																																																																																																																																																																																																																																																																																																																																																																																																																																																																																																																																																																																																																																																																																																																																																																																																																																																																																																																																																																																																																																																													
0	PLC	0	*																																																																																																																																																																																																																																																																																																																																																																																																																																																																																																																																																																																																																																																																																																																																																																																																																																																																																																																																																																																																																																																																																																																																																																																																																																																																																																																																																																																																																																																																																																																																																																																																																																																																																													
1	PLC	0	*																																																																																																																																																																																																																																																																																																																																																																																																																																																																																																																																																																																																																																																																																																																																																																																																																																																																																																																																																																																																																																																																																																																																																																																																																																																																																																																																																																																																																																																																																																																																																																																																																																																																																													
2	PLC	0	*																																																																																																																																																																																																																																																																																																																																																																																																																																																																																																																																																																																																																																																																																																																																																																																																																																																																																																																																																																																																																																																																																																																																																																																																																																																																																																																																																																																																																																																																																																																																																																																																																																																																																													
3	PLC	0	*																																																																																																																																																																																																																																																																																																																																																																																																																																																																																																																																																																																																																																																																																																																																																																																																																																																																																																																																																																																																																																																																																																																																																																																																																																																																																																																																																																																																																																																																																																																																																																																																																																																																																													
4	PLC	0	*																																																																																																																																																																																																																																																																																																																																																																																																																																																																																																																																																																																																																																																																																																																																																																																																																																																																																																																																																																																																																																																																																																																																																																																																																																																																																																																																																																																																																																																																																																																																																																																																																																																																																													
5	PLC	0	*																																																																																																																																																																																																																																																																																																																																																																																																																																																																																																																																																																																																																																																																																																																																																																																																																																																																																																																																																																																																																																																																																																																																																																																																																																																																																																																																																																																																																																																																																																																																																																																																																																																																																													
6	PLC	0	*																																																																																																																																																																																																																																																																																																																																																																																																																																																																																																																																																																																																																																																																																																																																																																																																																																																																																																																																																																																																																																																																																																																																																																																																																																																																																																																																																																																																																																																																																																																																																																																																																																																																																													
7	PLC	0	*																																																																																																																																																																																																																																																																																																																																																																																																																																																																																																																																																																																																																																																																																																																																																																																																																																																																																																																																																																																																																																																																																																																																																																																																																																																																																																																																																																																																																																																																																																																																																																																																																																																																																													
8	PLC	0	*																																																																																																																																																																																																																																																																																																																																																																																																																																																																																																																																																																																																																																																																																																																																																																																																																																																																																																																																																																																																																																																																																																																																																																																																																																																																																																																																																																																																																																																																																																																																																																																																																																																																																													
9	PLC	0	*																																																																																																																																																																																																																																																																																																																																																																																																																																																																																																																																																																																																																																																																																																																																																																																																																																																																																																																																																																																																																																																																																																																																																																																																																																																																																																																																																																																																																																																																																																																																																																																																																																																																																													
0	PLC	0	*																																																																																																																																																																																																																																																																																																																																																																																																																																																																																																																																																																																																																																																																																																																																																																																																																																																																																																																																																																																																																																																																																																																																																																																																																																																																																																																																																																																																																																																																																																																																																																																																																																																																																													
1	PLC	0	*																																																																																																																																																																																																																																																																																																																																																																																																																																																																																																																																																																																																																																																																																																																																																																																																																																																																																																																																																																																																																																																																																																																																																																																																																																																																																																																																																																																																																																																																																																																																																																																																																																																																																													
2	PLC	0	*																																																																																																																																																																																																																																																																																																																																																																																																																																																																																																																																																																																																																																																																																																																																																																																																																																																																																																																																																																																																																																																																																																																																																																																																																																																																																																																																																																																																																																																																																																																																																																																																																																																																																													
3	PLC	0	*																																																																																																																																																																																																																																																																																																																																																																																																																																																																																																																																																																																																																																																																																																																																																																																																																																																																																																																																																																																																																																																																																																																																																																																																																																																																																																																																																																																																																																																																																																																																																																																																																																																																																													
4	PLC	0	*																																																																																																																																																																																																																																																																																																																																																																																																																																																																																																																																																																																																																																																																																																																																																																																																																																																																																																																																																																																																																																																																																																																																																																																																																																																																																																																																																																																																																																																																																																																																																																																																																																																																																													
5	PLC	0	*																																																																																																																																																																																																																																																																																																																																																																																																																																																																																																																																																																																																																																																																																																																																																																																																																																																																																																																																																																																																																																																																																																																																																																																																																																																																																																																																																																																																																																																																																																																																																																																																																																																																																													
6	PLC	0	*																																																																																																																																																																																																																																																																																																																																																																																																																																																																																																																																																																																																																																																																																																																																																																																																																																																																																																																																																																																																																																																																																																																																																																																																																																																																																																																																																																																																																																																																																																																																																																																																																																																																																													
7	PLC	0	*																																																																																																																																																																																																																																																																																																																																																																																																																																																																																																																																																																																																																																																																																																																																																																																																																																																																																																																																																																																																																																																																																																																																																																																																																																																																																																																																																																																																																																																																																																																																																																																																																																																																																													
8	PLC	0	*																																																																																																																																																																																																																																																																																																																																																																																																																																																																																																																																																																																																																																																																																																																																																																																																																																																																																																																																																																																																																																																																																																																																																																																																																																																																																																																																																																																																																																																																																																																																																																																																																																																																																													
9	PLC	0	*																																																																																																																																																																																																																																																																																																																																																																																																																																																																																																																																																																																																																																																																																																																																																																																																																																																																																																																																																																																																																																																																																																																																																																																																																																																																																																																																																																																																																																																																																																																																																																																																																																																																																													
0	PLC	0	*																																																																																																																																																																																																																																																																																																																																																																																																																																																																																																																																																																																																																																																																																																																																																																																																																																																																																																																																																																																																																																																																																																																																																																																																																																																																																																																																																																																																																																																																																																																																																																																																																																																																																													
1	PLC	0	*																																																																																																																																																																																																																																																																																																																																																																																																																																																																																																																																																																																																																																																																																																																																																																																																																																																																																																																																																																																																																																																																																																																																																																																																																																																																																																																																																																																																																																																																																																																																																																																																																																																																																													
2	PLC	0	*																																																																																																																																																																																																																																																																																																																																																																																																																																																																																																																																																																																																																																																																																																																																																																																																																																																																																																																																																																																																																																																																																																																																																																																																																																																																																																																																																																																																																																																																																																																																																																																																																																																																																													
3	PLC	0	*																																																																																																																																																																																																																																																																																																																																																																																																																																																																																																																																																																																																																																																																																																																																																																																																																																																																																																																																																																																																																																																																																																																																																																																																																																																																																																																																																																																																																																																																																																																																																																																																																																																																																													
4	PLC	0	*																																																																																																																																																																																																																																																																																																																																																																																																																																																																																																																																																																																																																																																																																																																																																																																																																																																																																																																																																																																																																																																																																																																																																																																																																																																																																																																																																																																																																																																																																																																																																																																																																																																																																													
5	PLC	0	*																																																																																																																																																																																																																																																																																																																																																																																																																																																																																																																																																																																																																																																																																																																																																																																																																																																																																																																																																																																																																																																																																																																																																																																																																																																																																																																																																																																																																																																																																																																																																																																																																																																																																													
6	PLC	0	*																																																																																																																																																																																																																																																																																																																																																																																																																																																																																																																																																																																																																																																																																																																																																																																																																																																																																																																																																																																																																																																																																																																																																																																																																																																																																																																																																																																																																																																																																																																																																																																																																																																																																													
7	PLC	0	*																																																																																																																																																																																																																																																																																																																																																																																																																																																																																																																																																																																																																																																																																																																																																																																																																																																																																																																																																																																																																																																																																																																																																																																																																																																																																																																																																																																																																																																																																																																																																																																																																																																																																													
8	PLC	0	*																																																																																																																																																																																																																																																																																																																																																																																																																																																																																																																																																																																																																																																																																																																																																																																																																																																																																																																																																																																																																																																																																																																																																																																																																																																																																																																																																																																																																																																																																																																																																																																																																																																																																													
9	PLC	0	*																																																																																																																																																																																																																																																																																																																																																																																																																																																																																																																																																																																																																																																																																																																																																																																																																																																																																																																																																																																																																																																																																																																																																																																																																																																																																																																																																																																																																																																																																																																																																																																																																																																																																													
0	PLC	0	*																																																																																																																																																																																																																																																																																																																																																																																																																																																																																																																																																																																																																																																																																																																																																																																																																																																																																																																																																																																																																																																																																																																																																																																																																																																																																																																																																																																																																																																																																																																																																																																																																																																																																													
1	PLC	0	*																																																																																																																																																																																																																																																																																																																																																																																																																																																																																																																																																																																																																																																																																																																																																																																																																																																																																																																																																																																																																																																																																																																																																																																																																																																																																																																																																																																																																																																																																																																																																																																																																																																																																													
2	PLC	0	*																																																																																																																																																																																																																																																																																																																																																																																																																																																																																																																																																																																																																																																																																																																																																																																																																																																																																																																																																																																																																																																																																																																																																																																																																																																																																																																																																																																																																																																																																																																																																																																																																																																																																													
3	PLC	0	*																																																																																																																																																																																																																																																																																																																																																																																																																																																																																																																																																																																																																																																																																																																																																																																																																																																																																																																																																																																																																																																																																																																																																																																																																																																																																																																																																																																																																																																																																																																																																																																																																																																																																													
4	PLC	0	*																																																																																																																																																																																																																																																																																																																																																																																																																																																																																																																																																																																																																																																																																																																																																																																																																																																																																																																																																																																																																																																																																																																																																																																																																																																																																																																																																																																																																																																																																																																																																																																																																																																																																													
5	PLC	0	*																																																																																																																																																																																																																																																																																																																																																																																																																																																																																																																																																																																																																																																																																																																																																																																																																																																																																																																																																																																																																																																																																																																																																																																																																																																																																																																																																																																																																																																																																																																																																																																																																																																																																													
6	PLC	0	*																																																																																																																																																																																																																																																																																																																																																																																																																																																																																																																																																																																																																																																																																																																																																																																																																																																																																																																																																																																																																																																																																																																																																																																																																																																																																																																																																																																																																																																																																																																																																																																																																																																																																													
7	PLC	0	*																																																																																																																																																																																																																																																																																																																																																																																																																																																																																																																																																																																																																																																																																																																																																																																																																																																																																																																																																																																																																																																																																																																																																																																																																																																																																																																																																																																																																																																																																																																																																																																																																																																																																													
8	PLC	0	*																																																																																																																																																																																																																																																																																																																																																																																																																																																																																																																																																																																																																																																																																																																																																																																																																																																																																																																																																																																																																																																																																																																																																																																																																																																																																																																																																																																																																																																																																																																																																																																																																																																																																													
9	PLC	0	*																																																																																																																																																																																																																																																																																																																																																																																																																																																																																																																																																																																																																																																																																																																																																																																																																																																																																																																																																																																																																																																																																																																																																																																																																																																																																																																																																																																																																																																																																																																																																																																																																																																																																													
0	PLC	0	*																																																																																																																																																																																																																																																																																																																																																																																																																																																																																																																																																																																																																																																																																																																																																																																																																																																																																																																																																																																																																																																																																																																																																																																																																																																																																																																																																																																																																																																																																																																																																																																																																																																																																													
1	PLC	0	*																																																																																																																																																																																																																																																																																																																																																																																																																																																																																																																																																																																																																																																																																																																																																																																																																																																																																																																																																																																																																																																																																																																																																																																																																																																																																																																																																																																																																																																																																																																																																																																																																																																																																													
2	PLC	0	*																																																																																																																																																																																																																																																																																																																																																																																																																																																																																																																																																																																																																																																																																																																																																																																																																																																																																																																																																																																																																																																																																																																																																																																																																																																																																																																																																																																																																																																																																																																																																																																																																																																																																													
3	PLC	0	*																																																																																																																																																																																																																																																																																																																																																																																																																																																																																																																																																																																																																																																																																																																																																																																																																																																																																																																																																																																																																																																																																																																																																																																																																																																																																																																																																																																																																																																																																																																																																																																																																																																																																													
4	PLC	0	*																																																																																																																																																																																																																																																																																																																																																																																																																																																																																																																																																																																																																																																																																																																																																																																																																																																																																																																																																																																																																																																																																																																																																																																																																																																																																																																																																																																																																																																																																																																																																																																																																																																																																													
5	PLC	0	*																																																																																																																																																																																																																																																																																																																																																																																																																																																																																																																																																																																																																																																																																																																																																																																																																																																																																																																																																																																																																																																																																																																																																																																																																																																																																																																																																																																																																																																																																																																																																																																																																																																																																													
6	PLC	0	*																																																																																																																																																																																																																																																																																																																																																																																																																																																																																																																																																																																																																																																																																																																																																																																																																																																																																																																																																																																																																																																																																																																																																																																																																																																																																																																																																																																																																																																																																																																																																																																																																																																																																													
7	PLC	0	*																																																																																																																																																																																																																																																																																																																																																																																																																																																																																																																																																																																																																																																																																																																																																																																																																																																																																																																																																																																																																																																																																																																																																																																																																																																																																																																																																																																																																																																																																																																																																																																																																																																																																													
8	PLC	0	*																																																																																																																																																																																																																																																																																																																																																																																																																																																																																																																																																																																																																																																																																																																																																																																																																																																																																																																																																																																																																																																																																																																																																																																																																																																																																																																																																																																																																																																																																																																																																																																																																																																																																													
9	PLC	0	*																																																																																																																																																																																																																																																																																																																																																																																																																																																																																																																																																																																																																																																																																																																																																																																																																																																																																																																																																																																																																																																																																																																																																																																																																																																																																																																																																																																																																																																																																																																																																																																																																																																																																													
0	PLC	0	*																																																																																																																																																																																																																																																																																																																																																																																																																																																																																																																																																																																																																																																																																																																																																																																																																																																																																																																																																																																																																																																																																																																																																																																																																																																																																																																																																																																																																																																																																																																																																																																																																																																																																													
1	PLC	0	*																																																																																																																																																																																																																																																																																																																																																																																																																																																																																																																																																																																																																																																																																																																																																																																																																																																																																																																																																																																																																																																																																																																																																																																																																																																																																																																																																																																																																																																																																																																																																																																																																																																																																													
2	PLC	0	*																																																																																																																																																																																																																																																																																																																																																																																																																																																																																																																																																																																																																																																																																																																																																																																																																																																																																																																																																																																																																																																																																																																																																																																																																																																																																																																																																																																																																																																																																																																																																																																																																																																																																													
3	PLC	0	*																																																																																																																																																																																																																																																																																																																																																																																																																																																																																																																																																																																																																																																																																																																																																																																																																																																																																																																																																																																																																																																																																																																																																																																																																																																																																																																																																																																																																																																																																																																																																																																																																																																																																													
4	PLC	0	*																																																																																																																																																																																																																																																																																																																																																																																																																																																																																																																																																																																																																																																																																																																																																																																																																																																																																																																																																																																																																																																																																																																																																																																																																																																																																																																																																																																																																																																																																																																																																																																																																																																																																													
5	PLC	0	*																																																																																																																																																																																																																																																																																																																																																																																																																																																																																																																																																																																																																																																																																																																																																																																																																																																																																																																																																																																																																																																																																																																																																																																																																																																																																																																																																																																																																																																																																																																																																																																																																																																																																													
6	PLC	0	*																																																																																																																																																																																																																																																																																																																																																																																																																																																																																																																																																																																																																																																																																																																																																																																																																																																																																																																																																																																																																																																																																																																																																																																																																																																																																																																																																																																																																																																																																																																																																																																																																																																																																													
7	PLC	0	*																																																																																																																																																																																																																																																																																																																																																																																																																																																																																																																																																																																																																																																																																																																																																																																																																																																																																																																																																																																																																																																																																																																																																																																																																																																																																																																																																																																																																																																																																																																																																																																																																																																																																													
8	PLC	0	*																																																																																																																																																																																																																																																																																																																																																																																																																																																																																																																																																																																																																																																																																																																																																																																																																																																																																																																																																																																																																																																																																																																																																																																																																																																																																																																																																																																																																																																																																																																																																																																																																																																																																													
9	PLC	0	*																																																																																																																																																																																																																																																																																																																																																																																																																																																																																																																																																																																																																																																																																																																																																																																																																																																																																																																																																																																																																																																																																																																																																																																																																																																																																																																																																																																																																																																																																																																																																																																																																																																																																													
0	PLC	0	*																																																																																																																																																																																																																																																																																																																																																																																																																																																																																																																																																																																																																																																																																																																																																																																																																																																																																																																																																																																																																																																																																																																																																																																																																																																																																																																																																																																																																																																																																																																																																																																																																																																																																													
1	PLC	0	*																																																																																																																																																																																																																																																																																																																																																																																																																																																																																																																																																																																																																																																																																																																																																																																																																																																																																																																																																																																																																																																																																																																																																																																																																																																																																																																																																																																																																																																																																																																																																																																																																																																																																													
2	PLC	0	*																																																																																																																																																																																																																																																																																																																																																																																																																																																																																																																																																																																																																																																																																																																																																																																																																																																																																																																																																																																																																																																																																																																																																																																																																																																																																																																																																																																																																																																																																																																																																																																																																																																																																													
3	PLC	0	*																																																																																																																																																																																																																																																																																																																																																																																																																																																																																																																																																																																																																																																																																																																																																																																																																																																																																																																																																																																																																																																																																																																																																																																																																																																																																																																																																																																																																																																																																																																																																																																																																																																																																													
4	PLC	0	*																																																																																																																																																																																																																																																																																																																																																																																																																																																																																																																																																																																																																																																																																																																																																																																																																																																																																																																																																																																																																																																																																																																																																																																																																																																																																																																																																																																																																																																																																																																																																																																																																																																																																													
5	PLC	0	*																																																																																																																																																																																																																																																																																																																																																																																																																																																																																																																																																																																																																																																																																																																																																																																																																																																																																																																																																																																																																																																																																																																																																																																																																																																																																																																																																																																																																																																																																																																																																																																																																																																																																													
6	PLC	0	*																																																																																																																																																																																																																																																																																																																																																																																																																																																																																																																																																																																																																																																																																																																																																																																																																																																																																																																																																																																																																																																																																																																																																																																																																																																																																																																																																																																																																																																																																																																																																																																																																																																																																													
7	PLC	0	*																																																																																																																																																																																																																																																																																																																																																																																																																																																																																																																																																																																																																																																																																																																																																																																																																																																																																																																																																																																																																																																																																																																																																																																																																																																																																																																																																																																																																																																																																																																																																																																																																																																																																													
8	PLC	0	*																																																																																																																																																																																																																																																																																																																																																																																																																																																																																																																																																																																																																																																																																																																																																																																																																																																																																																																																																																																																																																																																																																																																																																																																																																																																																																																																																																																																																																																																																																																																																																																																																																																																																													
9	PLC	0	*																																																																																																																																																																																																																																																																																																																																																																																																																																																																																																																																																																																																																																																																																																																																																																																																																																																																																																																																																																																																																																																																																																																																																																																																																																																																																																																																																																																																																																																																																																																																																																																																																																																																																													
0	PLC	0	*																																																																																																																																																																																																																																																																																																																																																																																																																																																																																																																																																																																																																																																																																																																																																																																																																																																																																																																																																																																																																																																																																																																																																																																																																																																																																																																																																																																																																																																																																																																																																																																																																																																																																													
1	PLC	0	*																																																																																																																																																																																																																																																																																																																																																																																																																																																																																																																																																																																																																																																																																																																																																																																																																																																																																																																																																																																																																																																																																																																																																																																																																																																																																																																																																																																																																																																																																																																																																																																																																																																																																													
2	PLC	0	*																																																																																																																																																																																																																																																																																																																																																																																																																																																																																																																																																																																																																																																																																																																																																																																																																																																																																																																																																																																																																																																																																																																																																																																																																																																																																																																																																																																																																																																																																																																																																																																																																																																																																													
3	PLC	0	*																																																																																																																																																																																																																																																																																																																																																																																																																																																																																																																																																																																																																																																																																																																																																																																																																																																																																																																																																																																																																																																																																																																																																																																																																																																																																																																																																																																																																																																																																																																																																																																																																																																																																													
4	PLC	0	*																																																																																																																																																																																																																																																																																																																																																																																																																																																																																																																																																																																																																																																																																																																																																																																																																																																																																																																																																																																																																																																																																																																																																																																																																																																																																																																																																																																																																																																																																																																																																																																																																																																																																													
5	PLC	0	*																																																																																																																																																																																																																																																																																																																																																																																																																																																																																																																																																																																																																																																																																																																																																																																																																																																																																																																																																																																																																																																																																																																																																																																																																																																																																																																																																																																																																																																																																																																																																																																																																																																																																													
6	PLC	0	*																																																																																																																																																																																																																																																																																																																																																																																																																																																																																																																																																																																																																																																																																																																																																																																																																																																																																																																																																																																																																																																																																																																																																																																																																																																																																																																																																																																																																																																																																																																																																																																																																																																																																													
7	PLC	0	*																																																																																																																																																																																																																																																																																																																																																																																																																																																																																																																																																																																																																																																																																																																																																																																																																																																																																																																																																																																																																																																																																																																																																																																																																																																																																																																																																																																																																																																																																																																																																																																																																																																																																													
8	PLC	0	*																																																																																																																																																																																																																																																																																																																																																																																																																																																																																																																																																																																																																																																																																																																																																																																																																																																																																																																																																																																																																																																																																																																																																																																																																																																																																																																																																																																																																																																																																																																																																																																																																																																																																													
9	PLC	0	*																																																																																																																																																																																																																																																																																																																																																																																																																																																																																																																																																																																																																																																																																																																																																																																																																																																																																																																																																																																																																																																																																																																																																																																																																																																																																																																																																																																																																																																																																																																																																																																																																																																																																													
0	PLC	0	*																																																																																																																																																																																																																																																																																																																																																																																																																																																																																																																																																																																																																																																																																																																																																																																																																																																																																																																																																																																																																																																																																																																																																																																																																																																																																																																																																																																																																																																																																																																																																																																																																																																																																													
1	PLC	0	*																																																																																																																																																																																																																																																																																																																																																																																																																																																																																																																																																																																																																																																																																																																																																																																																																																																																																																																																																																																																																																																																																																																																																																																																																																																																																																																																																																																																																																																																																																																																																																																																																																																																																													
2	PLC	0	*																																																																																																																																																																																																																																																																																																																																																																																																																																																																																																																																																																																																																																																																																																																																																																																																																																																																																																																																																																																																																																																																																																																																																																																																																																																																																																																																																																																																																																																																																																																																																																																																																																																																																													
3	PLC	0	*																																																																																																																																																																																																																																																																																																																																																																																																																																																																																																																																																																																																																																																																																																																																																																																																																																																																																																																																																																																																																																																																																																																																																																																																																																																																																																																																																																																																																																																																																																																																																																																																																																																																																													
4	PLC	0	*																																																																																																																																																																																																																																																																																																																																																																																																																																																																																																																																																																																																																																																																																																																																																																																																																																																																																																																																																																																																																																																																																																																																																																																																																																																																																																																																																																																																																																																																																																																																																																																																																																																																																													
5	PLC	0	*																																																																																																																																																																																																																																																																																																																																																																																																																																																																																																																																																																																																																																																																																																																																																																																																																																																																																																																																																																																																																																																																																																																																																																																																																																																																																																																																																																																																																																																																																																																																																																																																																																																																																													
6	PLC	0	*																																																																																																																																																																																																																																																																																																																																																																																																																																																																																																																																																																																																																																																																																																																																																																																																																																																																																																																																																																																																																																																																																																																																																																																																																																																																																																																																																																																																																																																																																																																																																																																																																																																																																													
7	PLC	0	*																																																																																																																																																																																																																																																																																																																																																																																																																																																																																																																																																																																																																																																																																																																																																																																																																																																																																																																																																																																																																																																																																																																																																																																																																																																																																																																																																																																																																																																																																																																																																																																																																																																																																													
8	PLC	0	*																																																																																																																																																																																																																																																																																																																																																																																																																																																																																																																																																																																																																																																																																																																																																																																																																																																																																																																																																																																																																																																																																																																																																																																																																																																																																																																																																																																																																																																																																																																																																																																																																																																																																													
9	PLC	0	*																																																																																																																																																																																																																																																																																																																																																																																																																																																																																																																																																																																																																																																																																																																																																																																																																																																																																																																																																																																																																																																																																																																																																																																																																																																																																																																																																																																																																																																																																																																																																																																																																																																																																													
0	PLC	0	*																																																																																																																																																																																																																																																																																																																																																																																																																																																																																																																																																																																																																																																																																																																																																																																																																																																																																																																																																																																																																																																																																																																																																																																																																																																																																																																																																																																																																																																																																																																																																																																																																																																																																													
1	PLC	0	*																																																																																																																																																																																																																																																																																																																																																																																																																																																																																																																																																																																																																																																																																																																																																																																																																																																																																																																																																																																																																																																																																																																																																																																																																																																																																																																																																																																																																																																																																																																																																																																																																																																																																													
2	PLC	0	*																																																																																																																																																																																																																																																																																																																																																																																																																																																																																																																																																																																																																																																																																																																																																																																																																																																																																																																																																																																																																																																																																																																																																																																																																																																																																																																																																																																																																																																																																																																																																																																																																																																																																													
3	PLC	0	*																																																																																																																																																																																																																																																																																																																																																																																																																																																																																																																																																																																																																																																																																																																																																																																																																																																																																																																																																																																																																																																																																																																																																																																																																																																																																																																																																																																																																																																																																																																																																																																																																																																																																													
4	PLC	0	*																																																																																																																																																																																																																																																																																																																																																																																																																																																																																																																																																																																																																																																																																																																																																																																																																																																																																																																																																																																																																																																																																																																																																																																																																																																																																																																																																																																																																																																																																																																																																																																																																																																																																													
5	PLC	0	*																																																																																																																																																																																																																																																																																																																																																																																																																																																																																																																																																																																																																																																																																																																																																																																																																																																																																																																																																																																																																																																																																																																																																																																																																																																																																																																																																																																																																																																																																																																																																																																																																																																																																													
6	PLC	0	*																																																																																																																																																																																																																																																																																																																																																																																																																																																																																																																																																																																																																																																																																																																																																																																																																																																																																																																																																																																																																																																																																																																																																																																																																																																																																																																																																																																																																																																																																																																																																																																																																																																																																													
7	PLC	0	*																																																																																																																																																																																																																																																																																																																																																																																																																																																																																																																																																																																																																																																																																																																																																																																																																																																																																																																																																																																																																																																																																																																																																																																																																																																																																																																																																																																																																																																																																																																																																																																																																																																																																													
8	PLC	0	*																																																																																																																																																																																																																																																																																																																																																																																																																																																																																																																																																																																																																																																																																																																																																																																																																																																																																																																																																																																																																																																																																																																																																																																																																																																																																																																																																																																																																																																																																																																																																																																																																																																																																													
9	PLC	0	*																																																																																																																																																																																																																																																																																																																																																																																																																																																																																																																																																																																																																																																																																																																																																																																																																																																																																																																																																																																																																																																																																																																																																																																																																																																																																																																																																																																																																																																																																																																																																																																																																																																																																													
0	PLC	0	*																																																																																																																																																																																																																																																																																																																																																																																																																																																																																																																																																																																																																																																																																																																																																																																																																																																																																																																																																																																																																																																																																																																																																																																																																																																																																																																																																																																																																																																																																																																																																																																																																																																																																													
1	PLC	0	*																																																																																																																																																																																																																																																																																																																																																																																																																																																																																																																																																																																																																																																																																																																																																																																																																																																																																																																																																																																																																																																																																																																																																																																																																																																																																																																																																																																																																																																																																																																																																																																																																																																																																													
2	PLC	0	*																																																																																																																																																																																																																																																																																																																																																																																																																																																																																																																																																																																																																																																																																																																																																																																																																																																																																																																																																																																																																																																																																																																																																																																																																																																																																																																																																																																																																																																																																																																																																																																																																																																																																													
3	PLC	0	*																																																																																																																																																																																																																																																																																																																																																																																																																																																																																																																																																																																																																																																																																																																																																																																																																																																																																																																																																																																																																																																																																																																																																																																																																																																																																																																																																																																																																																																																																																																																																																																																																																																																																													
4	PLC	0	*																																																																																																																																																																																																																																																																																																																																																																																																																																																																																																																																																																																																																																																																																																																																																																																																																																																																																																																																																																																																																																																																																																																																																																																																																																																																																																																																																																																																																																																																																																																																																																																																																																																																																													
5	PLC	0	*																																																																																																																																																																																																																																																																																																																																																																																																																																																																																																																																																																																																																																																																																																																																																																																																																																																																																																																																																																																																																																																																																																																																																																																																																																																																																																																																																																																																																																																																																																																																																																																																																																																																																													
6	PLC	0	*																																																																																																																																																																																																																																																																																																																																																																																																																																																																																																																																																																																																																																																																																																																																																																																																																																																																																																																																																																																																																																																																																																																																																																																																																																																																																																																																																																																																																																																																																																																																																																																																																																																																																													
7	PLC	0	*																																																																																																																																																																																																																																																																																																																																																																																																																																																																																																																																																																																																																																																																																																																																																																																																																																																																																																																																																																																																																																																																																																																																																																																																																																																																																																																																																																																																																																																																																																																																																																																																																																																																																													
8	PLC	0	*																																																																																																																																																																																																																																																																																																																																																																																																																																																																																																																																																																																																																																																																																																																																																																																																																																																																																																																																																																																																																																																																																																																																																																																																																																																																																																																																																																																																																																																																																																																																																																																																																																																																																													
9	PLC	0	*																																																																																																																																																																																																																																																																																																																																																																																																																																																																																																																																																																																																																																																																																																																																																																																																																																																																																																																																																																																																																																																																																																																																																																																																																																																																																																																																																																																																																																																																																																																																																																																																																																																																																													
0	PLC	0	*																																																																																																																																																																																																																																																																																																																																																																																																																																																																																																																																																																																																																																																																																																																																																																																																																																																																																																																																																																																																																																																																																																																																																																																																																																																																																																																																																																																																																																																																																																																																																																																																																																																																																													
1	PLC	0	*																																																																																																																																																																																																																																																																																																																																																																																																																																																																																																																																																																																																																																																																																																																																																																																																																																																																																																																																																																																																																																																																																																																																																																																																																																																																																																																																																																																																																																																																																																																																																																																																																																																																																													
2	PLC	0	*																																																																																																																																																																																																																																																																																																																																																																																																																																																																																																																																																																																																																																																																																																																																																																																																																																																																																																																																																																																																																																																																																																																																																																																																																																																																																																																																																																																																																																																																																																																																																																																																																																																																																													
3	PLC	0	*																																																																																																																																																																																																																																																																																																																																																																																																																																																																																																																																																																																																																																																																																																																																																																																																																																																																																																																																																																																																																																																																																																																																																																																																																																																																																																																																																																																																																																																																																																																																																																																																																																																																																													
4	PLC	0	*																																																																																																																																																																																																																																																																																																																																																																																																																																																																																																																																																																																																																																																																																																																																																																																																																																																																																																																																																																																																																																																																																																																																																																																																																																																																																																																																																																																																																																																																																																																																																																																																																																																																																													
5	PLC	0	*																																																																																																																																																																																																																																																																																																																																																																																																																																																																																																																																																																																																																																																																																																																																																																																																																																																																																																																																																																																																																																																																																																																																																																																																																																																																																																																																																																																																																																																																																																																																																																																																																																																																																													
6	PLC	0	*																																																																																																																																																																																																																																																																																																																																																																																																																																																																																																																																																																																																																																																																																																																																																																																																																																																																																																																																																																																																																																																																																																																																																																																																																																																																																																																																																																																																																																																																																																																																																																																																																																																																																													
7	PLC	0	*																																																																																																																																																																																																																																																																																																																																																																																																																																																																																																																																																																																																																																																																																																																																																																																																																																																																																																																																																																																																																																																																																																																																																																																																																																																																																																																																																																																																																																																																																																																																																																																																																																																																																													
8	PLC	0	*																																																																																																																																																																																																																																																																																																																																																																																																																																																																																																																																																																																																																																																																																																																																																																																																																																																																																																																																																																																																																																																																																																																																																																																																																																																																																																																																																																																																																																																																																																																																																																																																																																																																																													
9	PLC	0	*																																																																																																																																																																																																																																																																																																																																																																																																																																																																																																																																																																																																																																																																																																																																																																																																																																																																																																																																																																																																																																																																																																																																																																																																																																																																																																																																																																																																																																																																																																																																																																																																																																																																																													
0	PLC	0	*																																																																																																																																																																																																																																																																																																																																																																																																																																																																																																																																																																																																																																																																																																																																																																																																																																																																																																																																																																																																																																																																																																																																																																																																																																																																																																																																																																																																																																																																																																																																																																																																																																																																																													
1	PLC	0	*																																																																																																																																																																																																																																																																																																																																																																																																																																																																																																																																																																																																																																																																																																																																																																																																																																																																																																																																																																																																																																																																																																																																																																																																																																																																																																																																																																																																																																																																																																																																																																																																																																																																																													
2	PLC	0	*																																																																																																																																																																																																																																																																																																																																																																																																																																																																																																																																																																																																																																																																																																																																																																																																																																																																																																																																																																																																																																																																																																																																																																																																																																																																																																																																																																																																																																																																																																																																																																																																																																																																																													
3	PLC	0	*																																																																																																																																																																																																																																																																																																																																																																																																																																																																																																																																																																																																																																																																																																																																																																																																																																																																																																																																																																																																																																																																																																																																																																																																																																																																																																																																																																																																																																																																																																																																																																																																																																																																																													
4	PLC	0	*																																																																																																																																																																																																																																																																																																																																																																																																																																																																																																																																																																																																																																																																																																																																																																																																																																																																																																																																																																																																																																																																																																																																																																																																																																																																																																																																																																																																																																																																																																																																																																																																																																																																																													
5	PLC	0	*																																																																																																																																																																																																																																																																																																																																																																																																																																																																																																																																																																																																																																																																																																																																																																																																																																																																																																																																																																																																																																																																																																																																																																																																																																																																																																																																																																																																																																																																																																																																																																																																																																																																																													
6	PLC	0	*																																																																																																																																																																																																																																																																																																																																																																																																																																																																																																																																																																																																																																																																																																																																																																																																																																																																																																																																																																																																																																																																																																																																																																																																																																																																																																																																																																																																																																																																																																																																																																																																																																																																																													
7	PLC	0	*																																																																																																																																																																																																																																																																																																																																																																																																																																																																																																																																																																																																																																																																																																																																																																																																																																																																																																																																																																																																																																																																																																																																																																																																																																																																																																																																																																																																																																																																																																																																																																																																																																																																																													
8	PLC	0	*																																																																																																																																																																																																																																																																																																																																																																																																																																																																																																																																																																																																																																																																																																																																																																																																																																																																																																																																																																																																																																																																																																																																																																																																																																																																																																																																																																																																																																																																																																																																																																																																																																																																																													
9	PLC	0	*																																																																																																																																																																																																																																																																																																																																																																																																																																																																																																																																																																																																																																																																																																																																																																																																																																																																																																																																																																																																																																																																																																																																																																																																																																																																																																																																																																																																																																																																																																																																																																																																																																																																																													
0	PLC	0	*																																																																																																																																																																																																																																																																																																																																																																																																																																																																																																																																																																																																																																																																																																																																																																																																																																																																																																																																																																																																																																																																																																																																																																																																																																																																																																																																																																																																																																																																																																																																																																																																																																																																																													
1	PLC	0	*																																																																																																																																																																																																																																																																																																																																																																																																																																																																																																																																																																																																																																																																																																																																																																																																																																																																																																																																																																																																																																																																																																																																																																																																																																																																																																																																																																																																																																																																																																																																																																																																																																																																																													
2	PLC	0	*																																																																																																																																																																																																																																																																																																																																																																																																																																																																																																																																																																																																																																																																																																																																																																																																																																																																																																																																																																																																																																																																																																																																																																																																																																																																																																																																																																																																																																																																																																																																																																																																																																																																																													
3	PLC	0	*																																																																																																																																																																																																																																																																																																																																																																																																																																																																																																																																																																																																																																																																																																																																																																																																																																																																																																																																																																																																																																																																																																																																																																																																																																																																																																																																																																																																																																																																																																																																																																																																																																																																																													
4	PLC	0	*																																																																																																																																																																																																																																																																																																																																																																																																																																																																																																																																																																																																																																																																																																																																																																																																																																																																																																																																																																																																																																																																																																																																																																																																																																																																																																																																																																																																																																																																																																																																																																																																																																																																																													
5	PLC	0	*																																																																																																																																																																																																																																																																																																																																																																																																																																																																																																																																																																																																																																																																																																																																																																																																																																																																																																																																																																																																																																																																																																																																																																																																																																																																																																																																																																																																																																																																																																																																																																																																																																																																																													
6	PLC	0	*																																																																																																																																																																																																																																																																																																																																																																																																																																																																																																																																																																																																																																																																																																																																																																																																																																																																																																																																																																																																																																																																																																																																																																																																																																																																																																																																																																																																																																																																																																																																																																																																																																																																																													
7	PLC	0	*																																																																																																																																																																																																																																																																																																																																																																																																																																																																																																																																																																																																																																																																																																																																																																																																																																																																																																																																																																																																																																																																																																																																																																																																																																																																																																																																																																																																																																																																																																																																																																																																																																																																																													
8	PLC	0	*																																																																																																																																																																																																																																																																																																																																																																																																																																																																																																																																																																																																																																																																																																																																																																																																																																																																																																																																																																																																																																																																																																																																																																																																																																																																																																																																																																																																																																																																																																																																																																																																																																																																																													
9	PLC	0	*																																																																																																																																																																																																																																																																																																																																																																																																																																																																																																																																																																																																																																																																																																																																																																																																																																																																																																																																																																																																																																																																																																																																																																																																																																																																																																																																																																																																																																																																																																																																																																																																																																																																																													
0	PLC	0	*																																																																																																																																																																																																																																																																																																																																																																																																																																																																																																																																																																																																																																																																																																																																																																																																																																																																																																																																																																																																																																																																																																																																																																																																																																																																																																																																																																																																																																																																																																																																																																																																																																																																																													
1	PLC	0	*																																																																																																																																																																																																																																																																																																																																																																																																																																																																																																																																																																																																																																																																																																																																																																																																																																																																																																																																																																																																																																																																																																																																																																																																																																																																																																																																																																																																																																																																																																																																																																																																																																																																																													
2	PLC	0	*																																																																																																																																																																																																																																																																																																																																																																																																																																																																																																																																																																																																																																																																																																																																																																																																																																																																																																																																																																																																																																																																																																																																																																																																																																																																																																																																																																																																																																																																																																																																																																																																																																																																																													
3	PLC	0	*																																																																																																																																																																																																																																																																																																																																																																																																																																																																																																																																																																																																																																																																																																																																																																																																																																																																																																																																																																																																																																																																																																																																																																																																																																																																																																																																																																																																																																																																																																																																																																																																																																																																																													
4	PLC	0	*																																																																																																																																																																																																																																																																																																																																																																																																																																																																																																																																																																																																																																																																																																																																																																																																																																																																																																																																																																																																																																																																																																																																																																																																																																																																																																																																																																																																																																																																																																																																																																																																																																																																																													
5	PLC	0	*																																																																																																																																																																																																																																																																																																																																																																																																																																																																																																																																																																																																																																																																																																																																																																																																																																																																																																																																																																																																																																																																																																																																																																																																																																																																																																																																																																																																																																																																																																																																																																																																																																																																																													
6	PLC	0	*																																																																																																																																																																																																																																																																																																																																																																																																																																																																																																																																																																																																																																																																																																																																																																																																																																																																																																																																																																																																																																																																																																																																																																																																																																																																																																																																																																																																																																																																																																																																																																																																																																																																																													
7	PLC	0	*																																																																																																																																																																																																																																																																																																																																																																																																																																																																																																																																																																																																																																																																																																																																																																																																																																																																																																																																																																																																																																																																																																																																																																																																																																																																																																																																																																																																																																																																																																																																																																																																																																																																																													
8	PLC	0	*																																																																																																																																																																																																																																																																																																																																																																																																																																																																																																																																																																																																																																																																																																																																																																																																																																																																																																																																																																																																																																																																																																																																																																																																																																																																																																																																																																																																																																																																																																																																																																																																																																																																																													
9	PLC	0	*																																																																																																																																																																																																																																																																																																																																																																																																																																																																																																																																																																																																																																																																																																																																																																																																																																																																																																																																																																																																																																																																																																																																																																																																																																																																																																																																																																																																																																																																																																																																																																																																																																																																																													
0	PLC	0	*																																																																																																																																																																																																																																																																																																																																																																																																																																																																																																																																																																																																																																																																																																																																																																																																																																																																																																																																																																																																																																																																																																																																																																																																																																																																																																																																																																																																																																																																																																																																																																																																																																																																																													
1	PLC	0	*																																																																																																																																																																																																																																																																																																																																																																																																																																																																																																																																																																																																																																																																																																																																																																																																																																																																																																																																																																																																																																																																																																																																																																																																																																																																																																																																																																																																																																																																																																																																																																																																																																																																																													
2	PLC	0	*																																																																																																																																																																																																																																																																																																																																																																																																																																																																																																																																																																																																																																																																																																																																																																																																																																																																																																																																																																																																																																																																																																																																																																																																																																																																																																																																																																																																																																																																																																																																																																																																																																																																																													
3	PLC	0	*																																																																																																																																																																																																																																																																																																																																																																																																																																																																																																																																																																																																																																																																																																																																																																																																																																																																																																																																																																																																																																																																																																																																																																																																																																																																																																																																																																																																																																																																																																																																																																																																																																																																																													
4	PLC	0	*																																																																																																																																																																																																																																																																																																																																																																																																																																																																																																																																																																																																																																																																																																																																																																																																																																																																																																																																																																																																																																																																																																																																																																																																																																																																																																																																																																																																																																																																																																																																																																																																																																																																																													
5	PLC	0	*																																																																																																																																																																																																																																																																																																																																																																																																																																																																																																																																																																																																																																																																																																																																																																																																																																																																																																																																																																																																																																																																																																																																																																																																																																																																																																																																																																																																																																																																																																																																																																																																																																																																																													
6	PLC	0	*																																																																																																																																																																																																																																																																																																																																																																																																																																																																																																																																																																																																																																																																																																																																																																																																																																																																																																																																																																																																																																																																																																																																																																																																																																																																																																																																																																																																																																																																																																																																																																																																																																																																																													
7	PLC	0	*																																																																																																																																																																																																																																																																																																																																																																																																																																																																																																																																																																																																																																																																																																																																																																																																																																																																																																																																																																																																																																																																																																																																																																																																																																																																																																																																																																																																																																																																																																																																																																																																																																																																																													
8	PLC	0	*																																																																																																																																																																																																																																																																																																																																																																																																																																																																																																																																																																																																																																																																																																																																																																																																																																																																																																																																																																																																																																																																																																																																																																																																																																																																																																																																																																																																																																																																																																																																																																																																																																																																																													
9	PLC	0	*																																																																																																																																																																																																																																																																																																																																																																																																																																																																																																																																																																																																																																																																																																																																																																																																																																																																																																																																																																																																																																																																																																																																																																																																																																																																																																																																																																																																																																																																																																																																																																																																																																																																																													
0	PLC	0	*																																																																																																																																																																																																																																																																																																																																																																																																																																																																																																																																																																																																																																																																																																																																																																																																																																																																																																																																																																																																																																																																																																																																																																																																																																																																																																																																																																																																																																																																																																																																																																																																																																																																																													
1	PLC	0	*																																																																																																																																																																																																																																																																																																																																																																																																																																																																																																																																																																																																																																																																																																																																																																																																																																																																																																																																																																																																																																																																																																																																																																																																																																																																																																																																																																																																																																																																																																																																																																																																																																																																																													
2	PLC	0	*																																																																																																																																																																																																																																																																																																																																																																																																																																																																																																																																																																																																																																																																																																																																																																																																																																																																																																																																																																																																																																																																																																																																																																																																																																																																																																																																																																																																																																																																																																																																																																																																																																																																																													
3	PLC	0	*																																																																																																																																																																																																																																																																																																																																																																																																																																																																																																																																																																																																																																																																																																																																																																																																																																																																																																																																																																																																																																																																																																																																																																																																																																																																																																																																																																																																																																																																																																																																																																																																																																																																																													
4	PLC	0	*																																																																																																																																																																																																																																																																																																																																																																																																																																																																																																																																																																																																																																																																																																																																																																																																																																																																																																																																																																																																																																																																																																																																																																																																																																																																																																																																																																																																																																																																																																																																																																																																																																																																																													
5	PLC	0	*																																																																																																																																																																																																																																																																																																																																																																																																																																																																																																																																																																																																																																																																																																																																																																																																																																																																																																																																																																																																																																																																																																																																																																																																																																																																																																																																																																																																																																																																																																																																																																																																																																																																																													
6	PLC	0	*																																																																																																																																																																																																																																																																																																																																																																																																																																																																																																																																																																																																																																																																																																																																																																																																																																																																																																																																																																																																																																																																																																																																																																																																																																																																																																																																																																																																																																																																																																																																																																																																																																																																																													
7	PLC	0	*																																																																																																																																																																																																																																																																																																																																																																																																																																																																																																																																																																																																																																																																																																																																																																																																																																																																																																																																																																																																																																																																																																																																																																																																																																																																																																																																																																																																																																																																																																																																																																																																																																																																																													
8	PLC	0	*																																																																																																																																																																																																																																																																																																																																																																																																																																																																																																																																																																																																																																																																																																																																																																																																																																																																																																																																																																																																																																																																																																																																																																																																																																																																																																																																																																																																																																																																																																																																																																																																																																																																																													
9	PLC	0	*																																																																																																																																																																																																																																																																																																																																																																																																																																																																																																																																																																																																																																																																																																																																																																																																																																																																																																																																																																																																																																																																																																																																																																																																																																																																																																																																																																																																																																																																																																																																																																																																																																																																																													
0	PLC	0	*																																																																																																																																																																																																																																																																																																																																																																																																																																																																																																																																																																																																																																																																																																																																																																																																																																																																																																																																																																																																																																																																																																																																																																																																																																																																																																																																																																																																																																																																																																																																																																																																																																																																																													
1	PLC	0	*																																																																																																																																																																																																																																																																																																																																																																																																																																																																																																																																																																																																																																																																																																																																																																																																																																																																																																																																																																																																																																																																																																																																																																																																																																																																																																																																																																																																																																																																																																																																																																																																																																																																																													
2	PLC	0	*																																																																																																																																																																																																																																																																																																																																																																																																																																																																																																																																																																																																																																																																																																																																																																																																																																																																																																																																																																																																																																																																																																																																																																																																																																																																																																																																																																																																																																																																																																																																																																																																																																																																																													
3	PLC	0	*																																																																																																																																																																																																																																																																																																																																																																																																																																																																																																																																																																																																																																																																																																																																																																																																																																																																																																																																																																																																																																																																																																																																																																																																																																																																																																																																																																																																																																																																																																																																																																																																																																																																																													
4	PLC	0	*																																																																																																																																																																																																																																																																																																																																																																																																																																																																																																																																																																																																																																																																																																																																																																																																																																																																																																																																																																																																																																																																																																																																																																																																																																																																																																																																																																																																																																																																																																																																																																																																																																																																																													
5	PLC	0	*																																																																																																																																																																																																																																																																																																																																																																																																																																																																																																																																																																																																																																																																																																																																																																																																																																																																																																																																																																																																																																																																																																																																																																																																																																																																																																																																																																																																																																																																																																																																																																																																																																																																																													
6	PLC	0	*																																																																																																																																																																																																																																																																																																																																																																																																																																																																																																																																																																																																																																																																																																																																																																																																																																																																																																																																																																																																																																																																																																																																																																																																																																																																																																																																																																																																																																																																																																																																																																																																																																																																																													
7	PLC	0																																																																																																																																																																																																																																																																																																																																																																																																																																																																																																																																																																																																																																																																																																																																																																																																																																																																																																																																																																																																																																																																																																																																																																																																																																																																																																																																																																																																																																																																																																																																																																																																																																																																																														