

# MODULAR CONNECTORS

Dip Type

CL 222 TM

Straight Dip Type

TM3R-6-\*(50)

CL No.	Part No.	RoHS
222-0114-3-50	TM3R-66(50)	YES
222-0071-2-50	TM3R-64(50)	

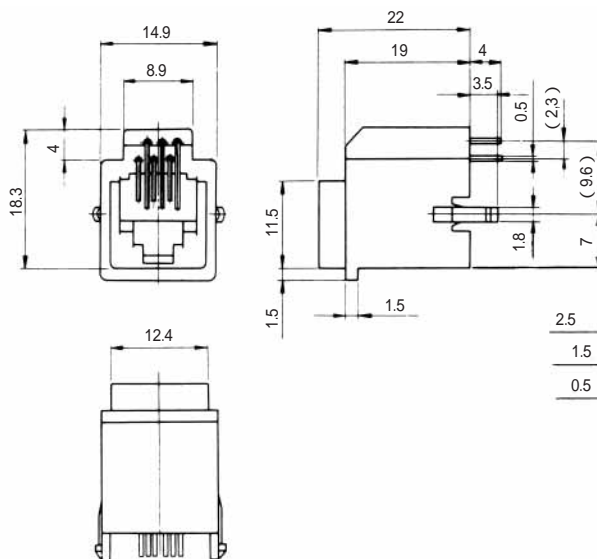
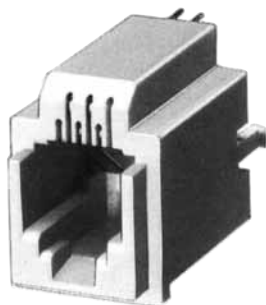

PCB mounting hole layout  
(Connector mounting side)

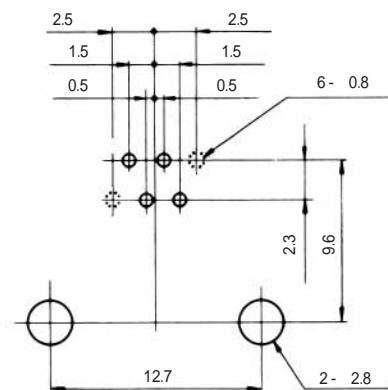

Note1: Standard finish color is vanilla white.

Note2: The drawing is shown sample of TM3R-66(50).

TM3RA-\*\*(50)

CL No.	Part No.	A	B	C	RoHS
222-0521-7-50	TM3RA-44(50)	12.9	6.9	10.4	YES
222-0567-8-50	TM3RA-62(50)	14.9	8.9	12.4	
222-0584-7-50	TM3RA-64(50)	14.9	8.9	12.4	
222-0770-1-50	TM3RA-66(50)	14.9	8.9	12.4	

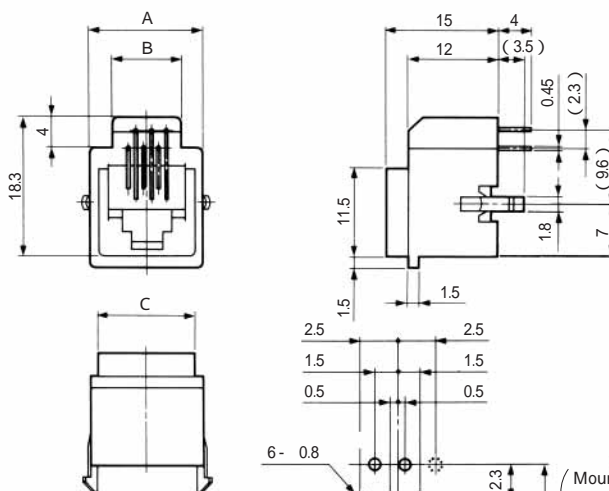
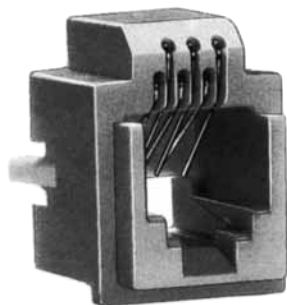

PCB mounting hole layout  
(Connector mounting side)

TM3RA-44

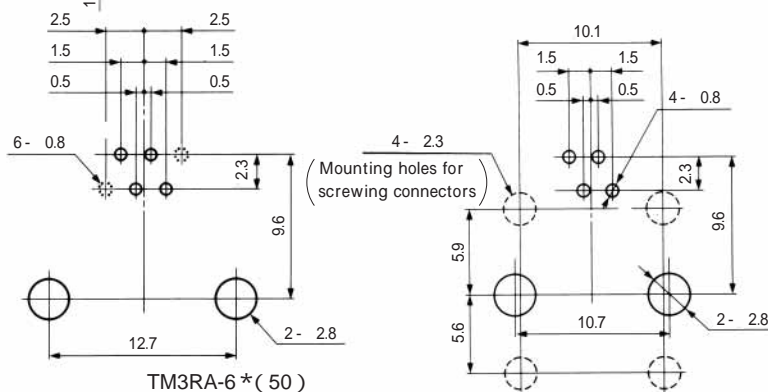

Note1: Standard finish color is vanilla white.

Note2: The drawing is shown sample of TM3RA-66(50).

# MODULAR CONNECTORS

CL 222 TM

## TM3RA-88( 50 )

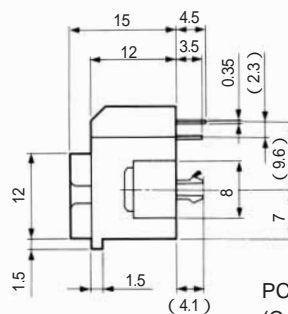
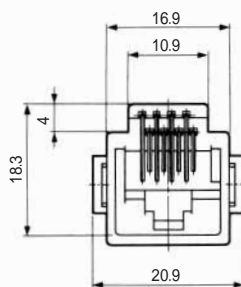
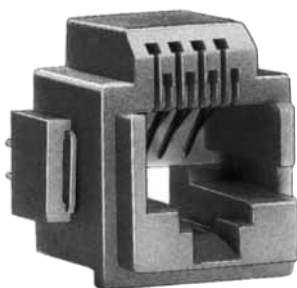

PCB mounting hole layout  
(Connector mounting side)

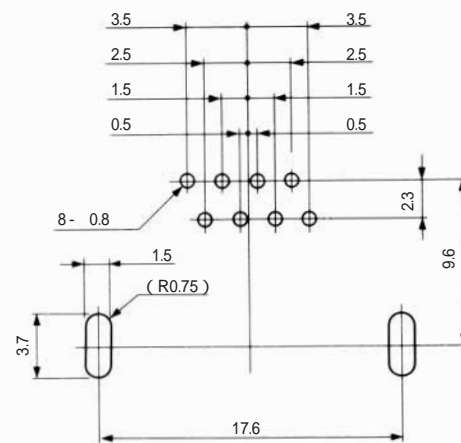
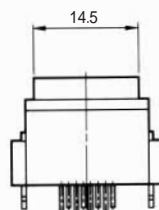

CL No.	Part No.	RoHS
222-1012-9-50	TM3RA-88( 50 )	YES

Note1: ( 50 )Stick packaging... 27 units.

Note2: Standard finish color is vanilla white.

## TM3RA1- \* \*( \* \* )

CL No.	Part No.	A	B	C	D	RoHS
222-1374-0-67	TM3RA1-44( 67 )	12.9	6.9	10.4	11	YES
222-1375-2-60	TM3RA1-62( 60 )	14.9	8.9	12.4	13	
222-1376-5-67	TM3RA1-64( 67 )	14.9	8.9	12.4	13	
222-1377-8-67	TM3RA1-66( 67 )	14.9	8.9	12.4	13	

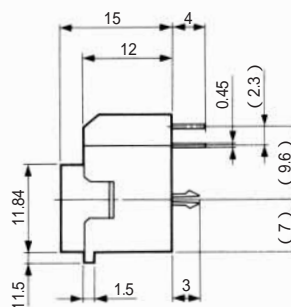
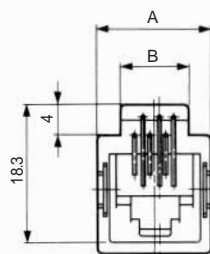

PCB mounting hole layout  
(Connector mounting side)

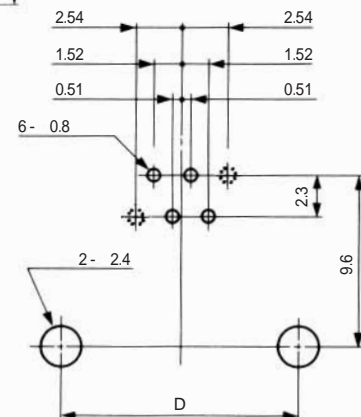
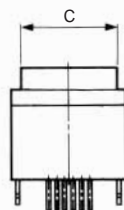

Note1:( 67 )Stick packaging, type 44 .... 42 units.  
 type 6 \* ... 36 units.

Note2: Standard finish color is black.

Note3: The drawing is shown sample of TM3RA1-66( 67 ).

# MODULAR CONNECTORS

CL 222 TM

## Gang-Jacks Straight Dip Type

### TM2RE-06 \* \*( 50 )

CL No.	Part No.	RoHS
222-1286-4-50	TM2RE-0602( 50 )	YES
222-1391-9-50	TM2RE-0604( 50 )	
222-1422-0-50	TM2RE-0606( 50 )	

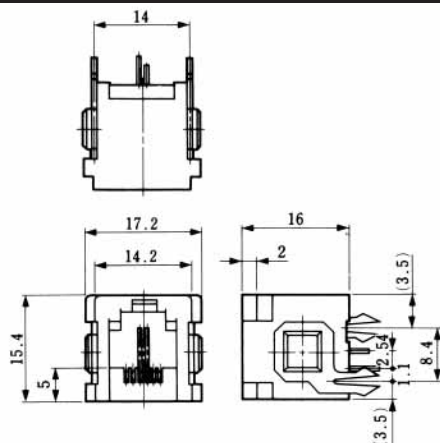
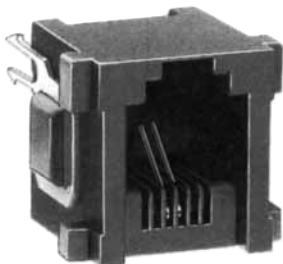

PCB mounting hole layout  
(Connector mounting side)

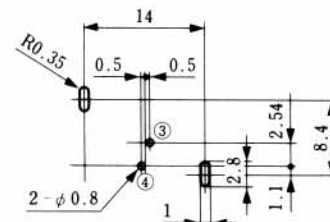

TM2RE-0602( 50 )

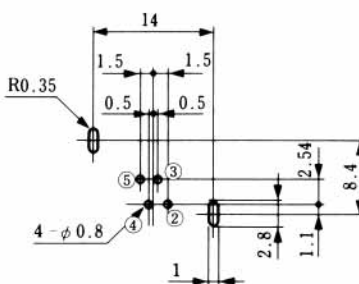

TM2RE-0604( 50 )

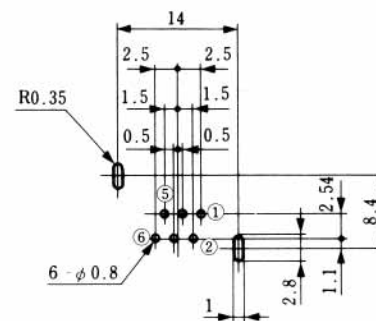

TM2RE-0606( 50 )

Note 1: Standard finish color is gray.

Note 2: The drawing is shown sample of TM2RE-0602( 50 ).

### TM2RE-12 \* \*( 50 )

CL No.	Part No.	RoHS
222-0592-5-50	TM2RE-1204( 50 )	YES
222-0756-0-50	TM2RE-1208( 50 )	
222-0757-3-50	TM2RE-1212( 50 )	

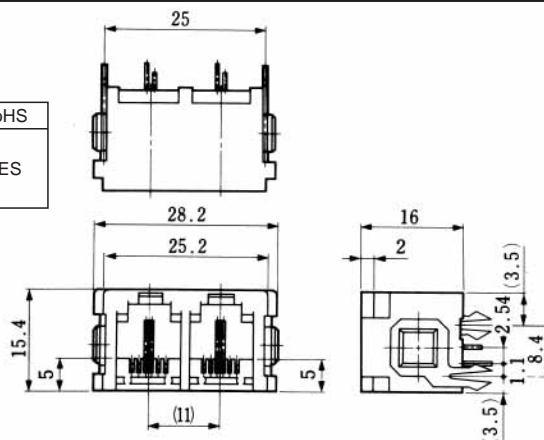
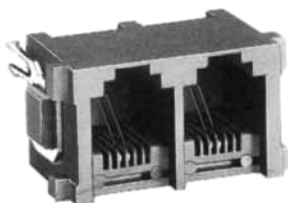

PCB mounting hole layout  
(Connector mounting side)

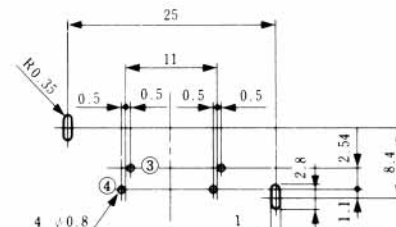

TM2RE-1204( 50 )

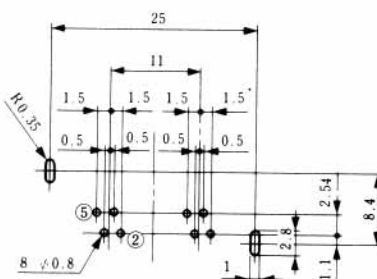

TM2RE-1208( 50 )

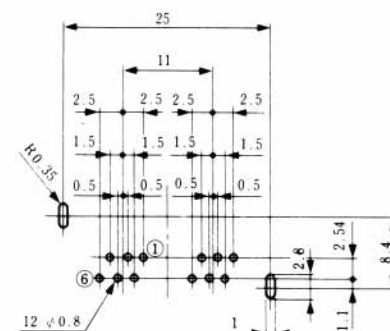

TM2RE-1212( 50 )

Note 1: Standard finish color is gray.

Note 2: The drawing is shown sample of TM2RE-1204( 50 ).



# MODULAR CONNECTORS

CL 222 TM

## TM3RA1-1010A( 50 )

CL No.	Part No.	RoHS
222-2526-1-50	TM3RA1-1010A( 50 )	YES

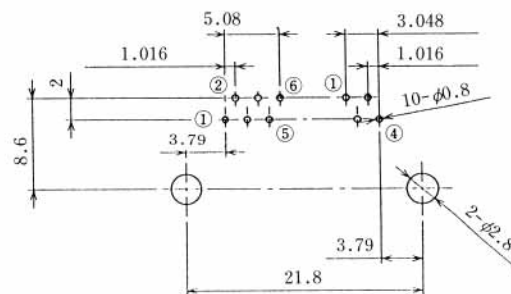
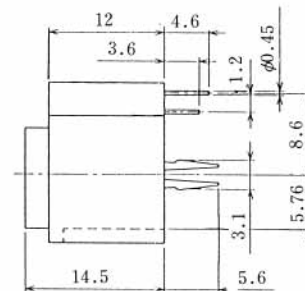
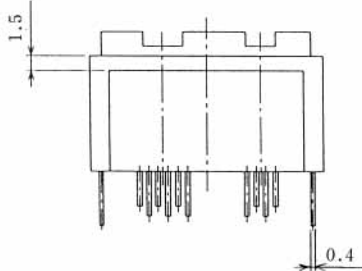
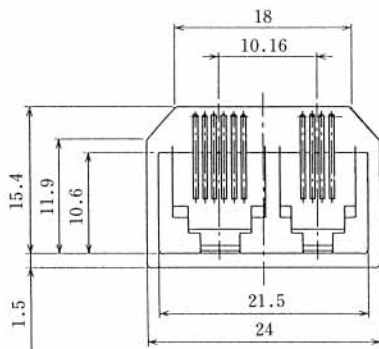
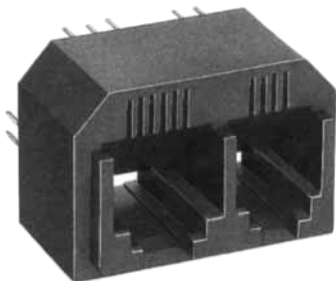

PCB mounting hole layout  
(Connector mounting side)

Note : Standard finish color is black.

## TM3RB1-1010( 50 )

CL No.	Part No.	RoHS
222-2598-2-50	TM3RB1-1010( 50 )	YES

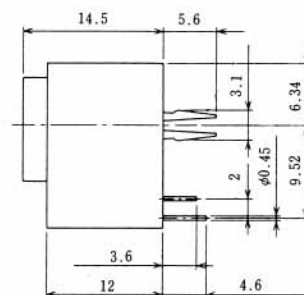
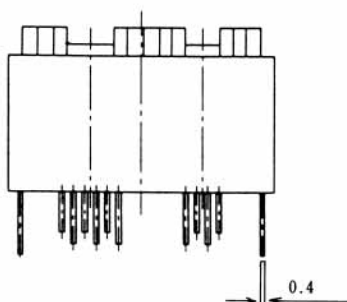
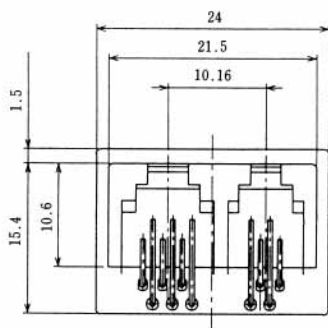
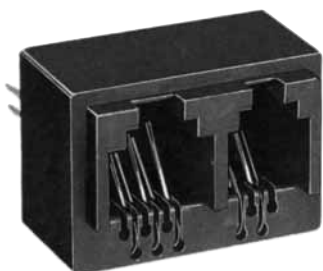

PCB mounting hole layout  
(Connector mounting side)

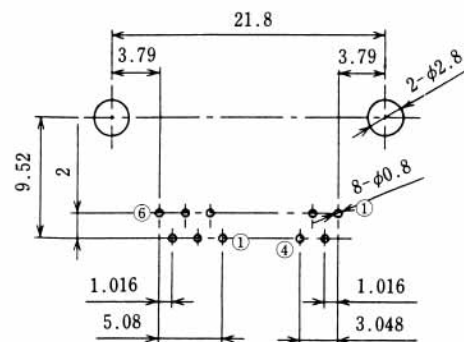

Note : Standard finish color is black.