

Single Slot SMT Connectors For Card-Bus Based PC Cards

IC11S Series

PC Card Standard Compliant

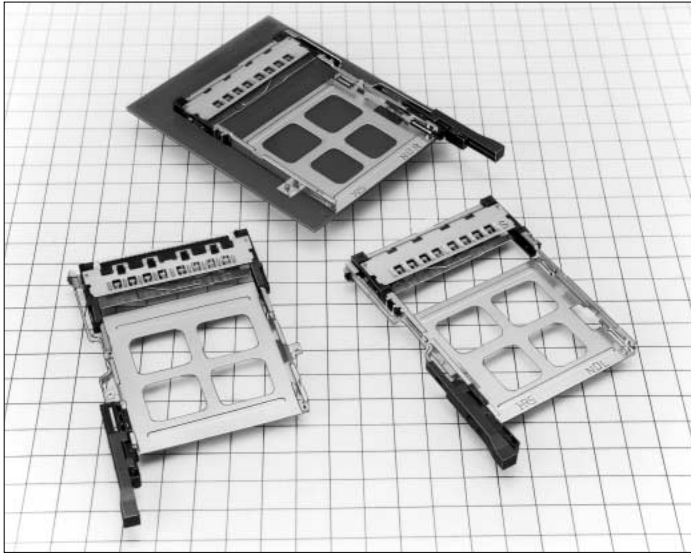

■ Features

1. Meets requirements of the PC card standard

Grounding reliability, required for high-speed signal transmission, is guaranteed with a ground plate and 8 grounding contacts. Type I, II and III PC cards can be used.

2. Board space saving

Small size, efficient use of materials reduced board mounting area allowing reduction in conductive pattern-prohibited areas.

3. Low profile

Reduced overall height allows it to be incorporated in very small devices.

4. Efficient and reliable ejection mechanism

Our unique ejection mechanism design allows the PC card to be reliably ejected at the distance sufficient for easy hand-removal.

5. Wide variety of options

- Mounting: Standard - top of the PCB, Reverse – under the PCB
- Ejection buttons: Rigid, Folding, Pop-up. All can be left or right side.
- Standoff version: 2.2mm above the board surface, allowing space for other components to be mounted under the connector.

6. Light weight

Pop-up button version 2 connector is 12% lighter than comparable connector on version 1.

■ Applications

Notebook PCs, desktop PCs, audio/video equipment and other devices utilizing PC cards.

Low profile



Wide variety of options

(1) Board Mounting

- ① Standard type
- ② Reverse type

(2) Eject button type

- ① Rigid
- ② Folding
- ③ Pop-up (Version 1, 2)

(3) Position of eject button

- ① Right
- ② Left

(4) Standoffs

- ① None
- ② 2.2mm



Standard type



Reverse type

Product Specifications

Ratings	Current rating	0.5A	Operating temperature	-55°C to +85°C(Note.1)	Storage temperature	-40°C to +70°C(Note.2)
	Voltage rating	125V AC	Operating humidity	Relative humidity 95% max. (No condensation)	Storage humidity	40% to 70%(Note.2)

Item	Specification	Conditions
1.Insulation resistance	1000MΩ min.	500V DC
2.Withstanding voltage	No flashover or insulation breakdown.	500V AC
3.Contact resistance	60mΩ max. (initial value)	1mA
4.Vibration	No electrical discontinuity of 100ns or more	Frequency: 10 to 2000 Hz, full amplitude of 1.52 mm or acceleration of 147 m/s ² (peak), 4 hours in each of the 3 directions.
5.Humidity (Steady state)	Insulation resistance: 100MΩ min.	96 hours at temperature of 40°C and humidity of 90% to 95%
6.Temperature cycle	Insulation resistance: 100MΩ min.	Temperature: -55°C → +5°C to +35°C → +85°C → +5°C to +35°C Duration: 30 → 5 max. → 30 → 5 max. (Minutes) 5 cycles
7.Durability (Insertion/withdrawal)	Variations from initial contact resistance: 20mΩ max.	10000 cycles at 400 to 600 cycles per hour
8.Resistance to Soldering heat	No deformation of components affecting performance.	Reflow: At the recommended temperature profile
		Manual soldering: 300°C for 3 seconds

Note 1: Includes temperature rise caused by current flow.

Note 2: The term "storage" refers to products stored for long period of time prior to mounting and use. Operating Temperature Range and Humidity range covers non- conducting condition of installed connectors in storage, shipment or during transportation.

Materials / Finish

●SMT unit

Parts		Material	Finish	Remarks
Insulator		PPS	Color : Black	UL94V-0
Terminal	Card connected section	Brass	Contact area: Gold plated Termination area: Tin-lead plated	—
	Ground plate	Phosphor bronze	Contact area: Gold plated Termination area: Tin-lead plated	—
Eject metal components		Stainless steel	—	—

●Guide unit

Description		Material	Finish	Remarks	
Guide plate		Stainless steel	—	—	
Pushrod		Stainless steel	—	—	
Eject button	Rigid button	Body	PBT	Color : Black UL94V-0	
		Body	PBT	Color: Black UL94V-0	
	Foldering button	Spring	Stainless steel	—	—
		Spring Pin	Stainless steel	—	—
		Body	PBT	Color: Black UL94V-0	
	Pop-up Version 1	Frame metal	Stainless steel	—	—
		Spring	Steel	—	—
Pin		Brass	Nickel plated	—	
Nut (Note)		Steel	—	M2x0.4	
Eject button	Pop-up Version 2	Body	PBT	Color: Black UL94V-0	
		Spring	Steel	—	
		Cam	Zinc alloy	—	

Note: Rectangular nut is integrated in the guide unit (Pop-up button, Version 2 connectors).

■ Ordering Information

● SMT Unit

IC11S
①
A
②
-
68
③
PLR
④
-
1.27SF
⑤
-
EJ
⑥
R
⑦
(71)
⑧

<p>① Series name : IC11S</p>	<p>⑤ 1.27SF : 1.27mm pitch SMT connector (Note)</p>
<p>② Standoff type Blank : none A : 2.2mm</p>	<p>⑥ With ejector</p>
<p>③ Number of contacts : 68 (Note)</p>	<p>⑦ Eject button positions R : right L : left</p>
<p>④ Board Mounting type PL : standard type PLR : reverse type</p>	<p>⑧ Product specification code Blank : Tin-lead plated (71) : Lead free plated Note: 68 and 1.27 are not used in the part number for the lead-free type.</p>

● Guide Unit

IC11S
⑨
A
⑩
-
BUR
⑪
-
PNEJ
⑫
R
⑬

<p>⑨ Series name : IC11S</p>	<p>⑫ Eject button type EJ : Rigid FEJ : Folding PEJ : Pop-up, Version 1 PNEJ : Pop-up, Version 2</p>
<p>⑩ Standoff type Blank: none A : 2.2mm</p>	<p>⑬ Eject button positions R : right L : left</p>
<p>⑪ Board Mounting type BD : standard type BUR : reverse type</p>	

Note: In this Series the SMT unit and the Guide unit must be used in combinations shown below.
 Other combinations cannot be used.

- Series name (① ⇔ ⑨)
- Standoff type (② ⇔ ⑩)
- Board Mounting type (④ ⇔ ⑪)
- Eject button positions (⑦ ⇔ ⑬)

Standard Right rigid button

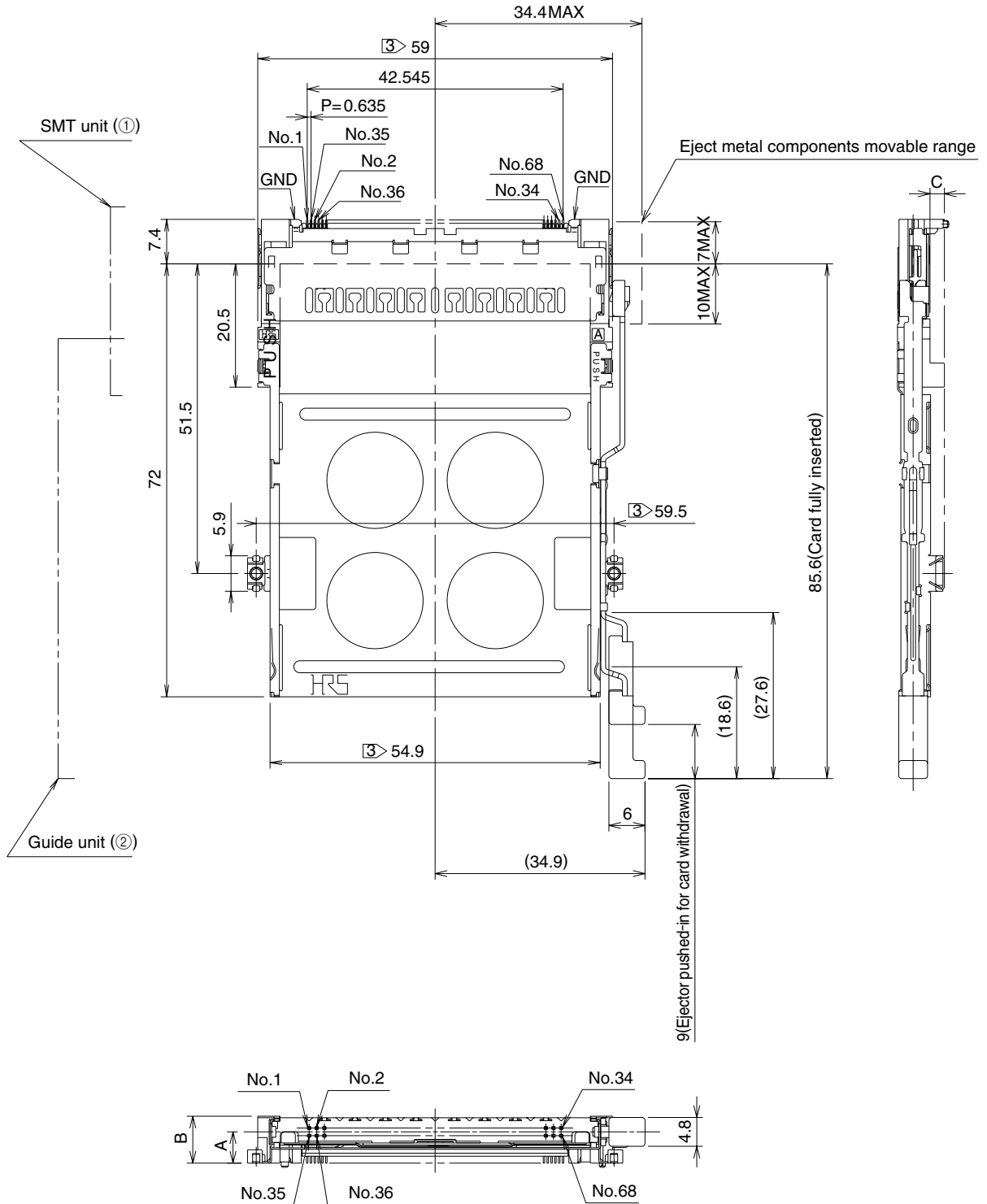

Standoff type	SMT unit ①		Guide unit ②		A (mm)	B (mm)	C (mm)	Weight (g)
	Part Number	CL No.	Part Number	CL No.				
None	IC11S-68PL-1.27SF-EJR	640-1007-3	IC11S-BD-EJR	640-1071-2	3	5.6	0.1	12.7
2.2mm	IC11SA-68PL-1.27SF-EJR	640-1009-9	IC11SA-BD-EJR	640-1073-8	5.2	7.8	2.3	13.1

Note 1: All illustrations show the SMT unit (1) and Guide unit (2) assembled.

Note 2: Dimensions for card insertion are in accordance with "PC card standard".

3 > : Indicated dimensions are symmetrical to the center of the card insertion slot.

Standard Left rigid button

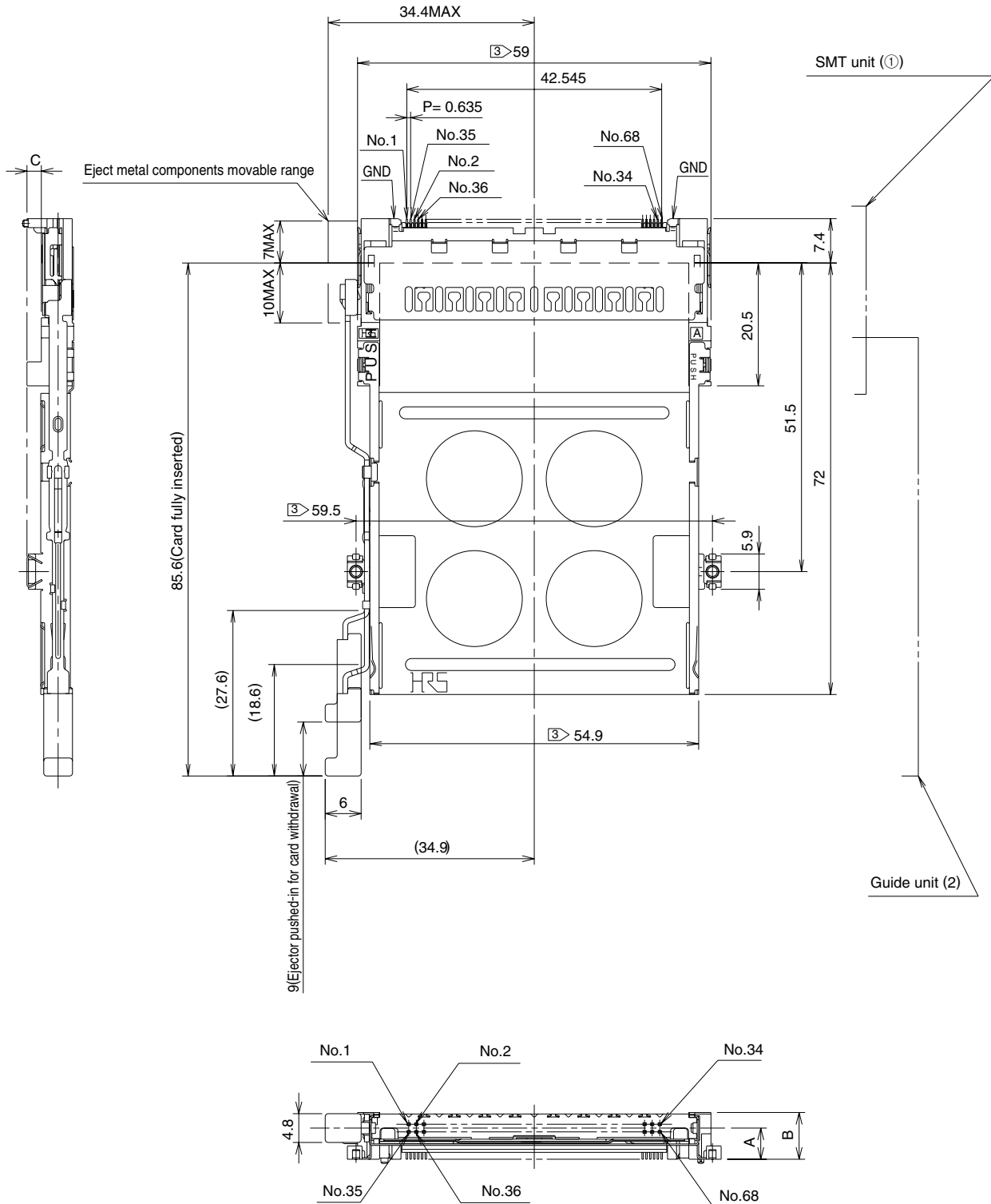

Standoff type	SMT unit ①		Guide unit ②		A (mm)	B (mm)	C (mm)	Weight (g)
	Part Number	CL No.	Part Number	CL No.				
None	IC11S-68PL-1.27SF-EJL	640-1008-6	IC11S-BD-EJL	640-1072-5	3	5.6	0.1	12.7
2.2mm	IC11SA-68PL-1.27SF-EJL	640-1010-8	IC11SA-BD-EJL	640-1074-0	5.2	7.8	2.3	13.1

Note 1: All illustrations show the SMT unit (①) and Guide unit (②) assembled.

Note 2: Dimensions for card insertion are in accordance with "PC card standard".

③ : Indicated dimensions are symmetrical to the center of the card insertion slot.

Standard Right folding button

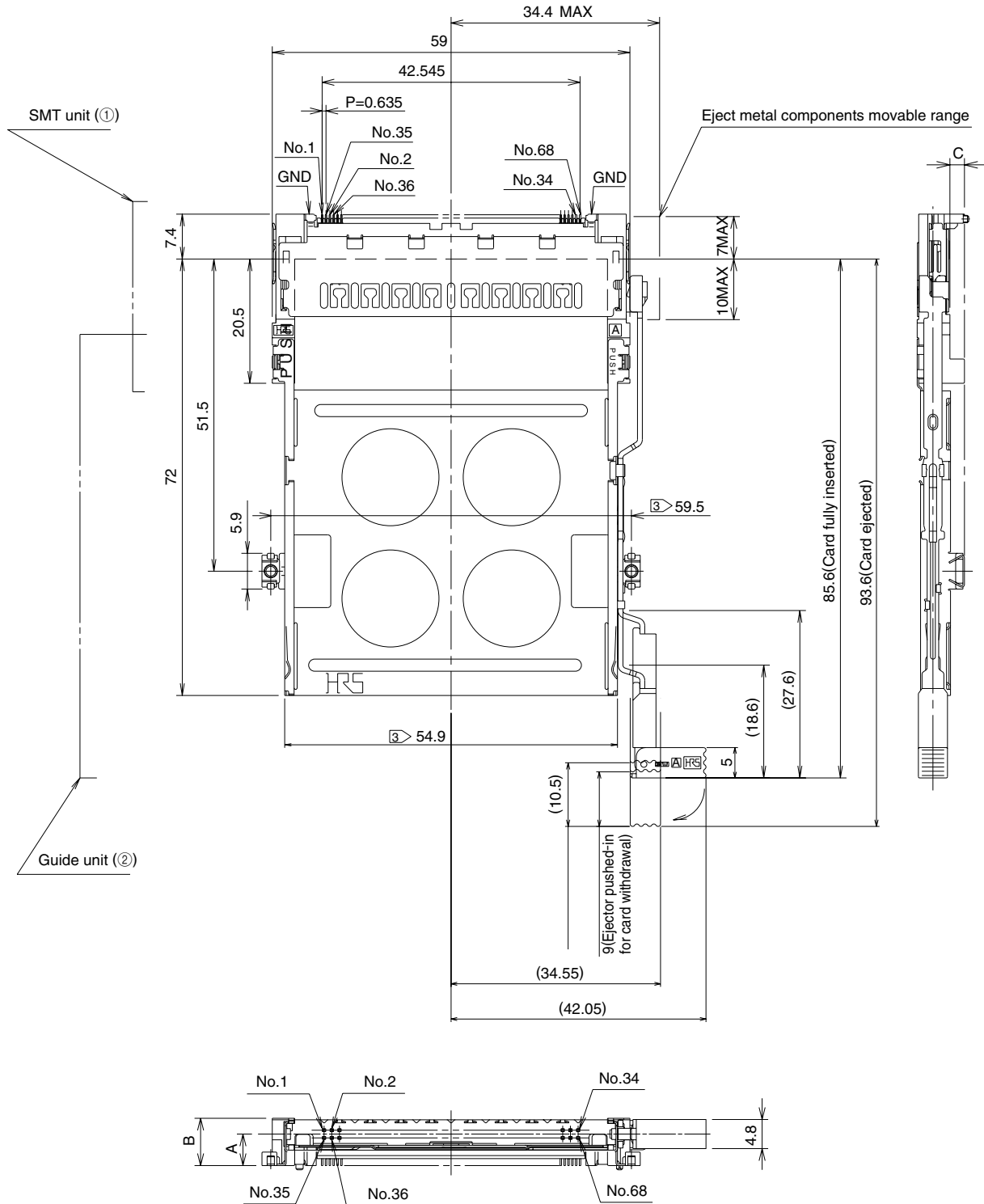

Standoff type	SMT unit ①		Guide unit ②		A (mm)	B (mm)	C (mm)	Weight (g)
	Part Number	CL No.	Part Number	CL No.				
None	IC11S-68PL-1.27SF-EJR	640-1007-3	IC11S-BD-FEJR	640-1075-3	3	5.6	0.1	13.1
2.2mm	IC11SA-68PL-1.27SF-EJR	640-1009-9	IC11SA-BD-FEJR	640-1077-9	5.2	7.8	2.3	13.5

Note 1: All illustrations show the SMT unit (①) and Guide unit (②) assembled.

Note 2: Dimensions for card insertion are in accordance with "PC card standard".

③ : Indicated dimensions are symmetrical to the center of the card insertion slot.

Standard Left folding button

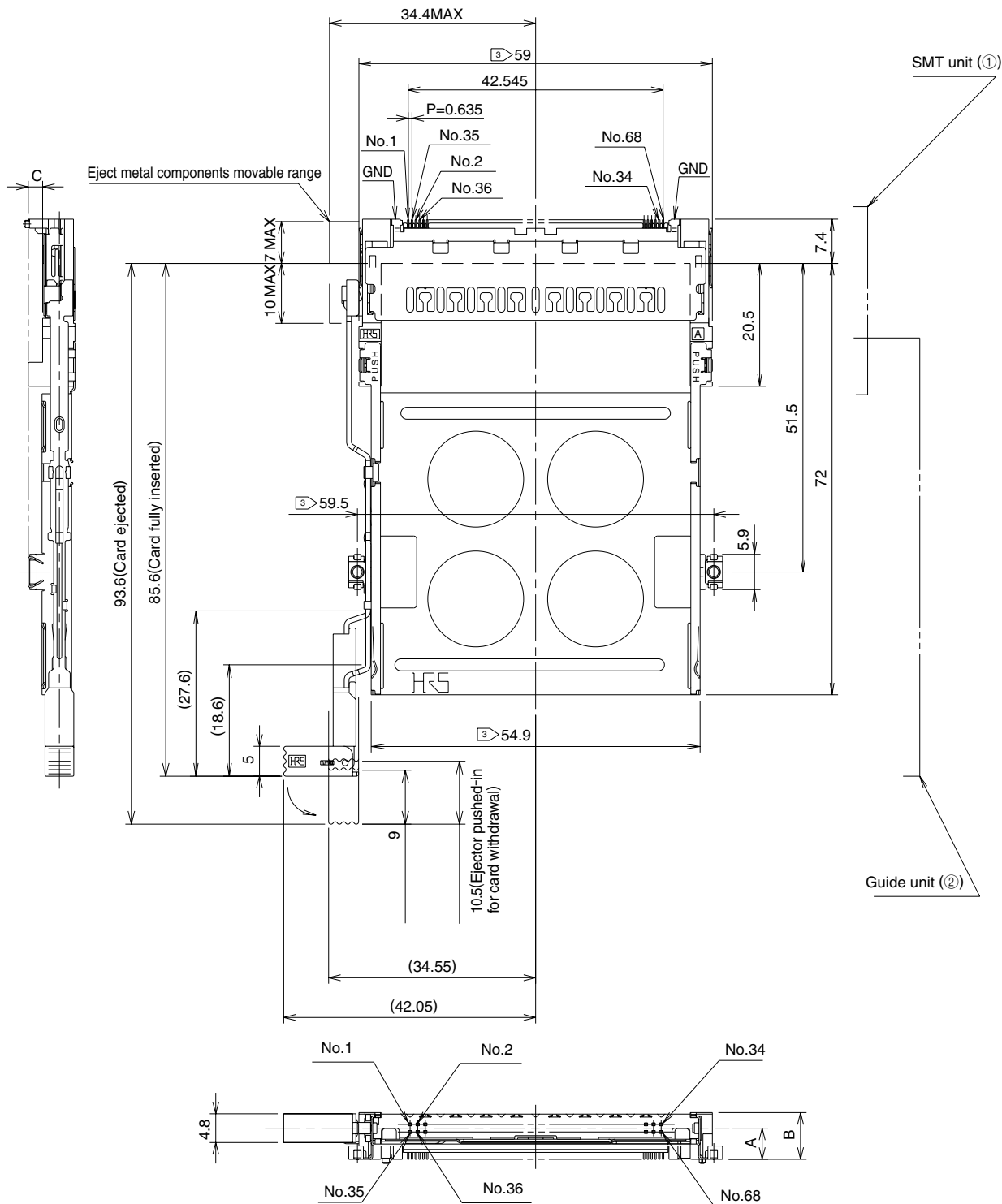

Standoff type	SMT unit ①		Guide unit ②		A (mm)	B (mm)	C (mm)	Weight (g)
	Part Number	CL No.	Part Number	CL No.				
None	IC11S-68PL-1.27SF-EJL	640-1008-6	IC11S-BD-FEJL	640-1076-6	3	5.6	0.1	13.1
2.2mm	IC11SA-68PL-1.27SF-EJL	640-1010-8	IC11SA-BD-FEJL	640-1078-1	5.2	7.8	2.3	13.5

Note 1: All illustrations show the SMT unit (①) and Guide unit (②) assembled.

Note 2: Dimensions for card insertion are in accordance with "PC card standard".

③ : Indicated dimensions are symmetrical to the center of the card insertion slot.

Standard Right Pop-up button (Version 1)

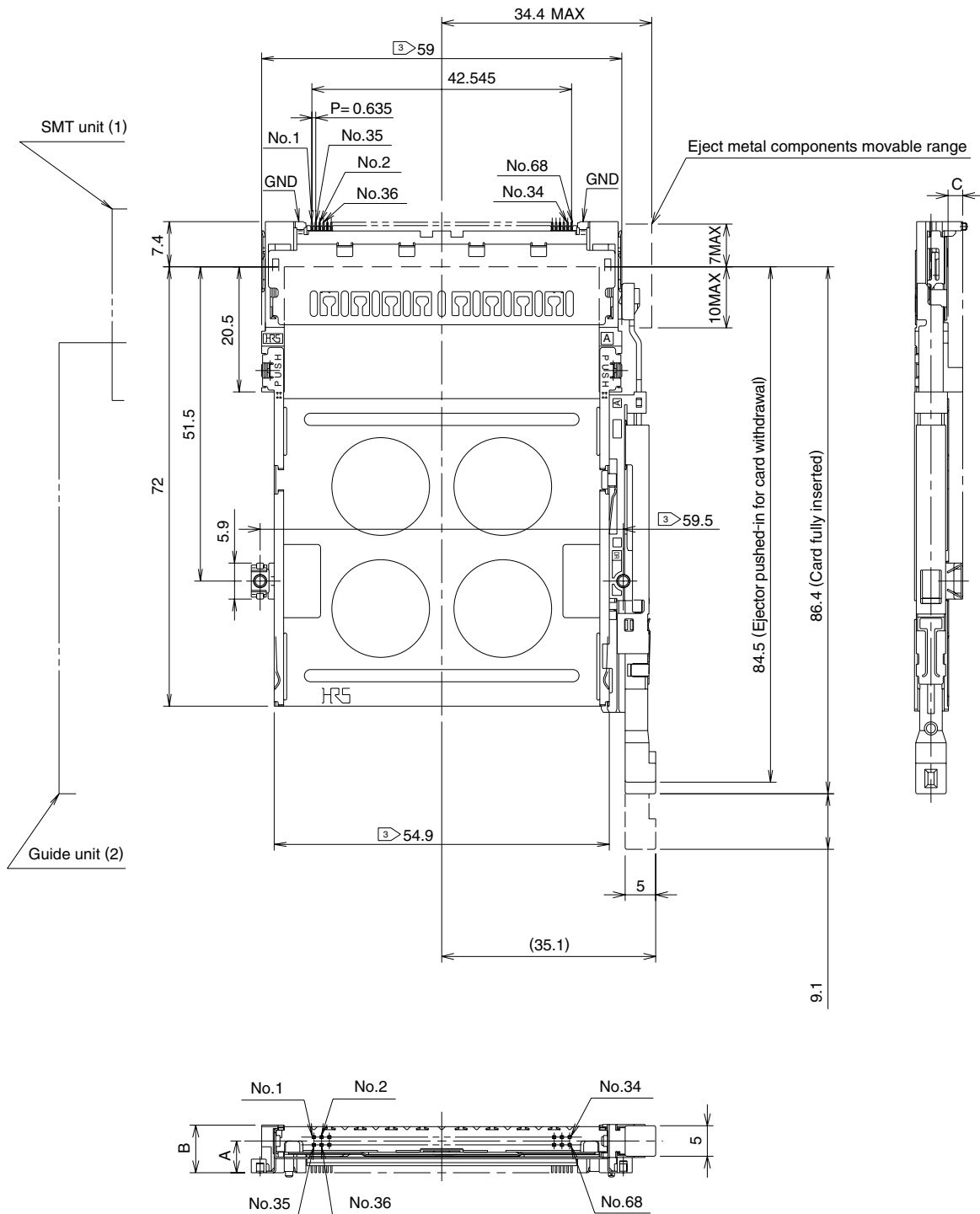

Standoff type	SMT unit ①		Guide unit ②		A (mm)	B (mm)	C (mm)	Weight (g)
	Part Number	CL No.	Part Number	CL No.				
None	IC11S-68PL-1.27SF-EJR	640-1007-3	IC11S-BD-PEJR	640-1081-6	3	5.7	0.1	14.7
2.2mm	IC11SA-68PL-1.27SF-EJR	640-1009-9	IC11SA-BD-PEJR	640-1083-1	5.2	7.9	2.3	15.1

Note 1: All illustrations show the SMT unit (①) and Guide unit (②) assembled.

Note 2: Dimensions for card insertion are in accordance with "PC card standard".

③ : Indicated dimensions are symmetrical to the center of the card insertion slot.

Standard Left Pop-up button (Version 1)

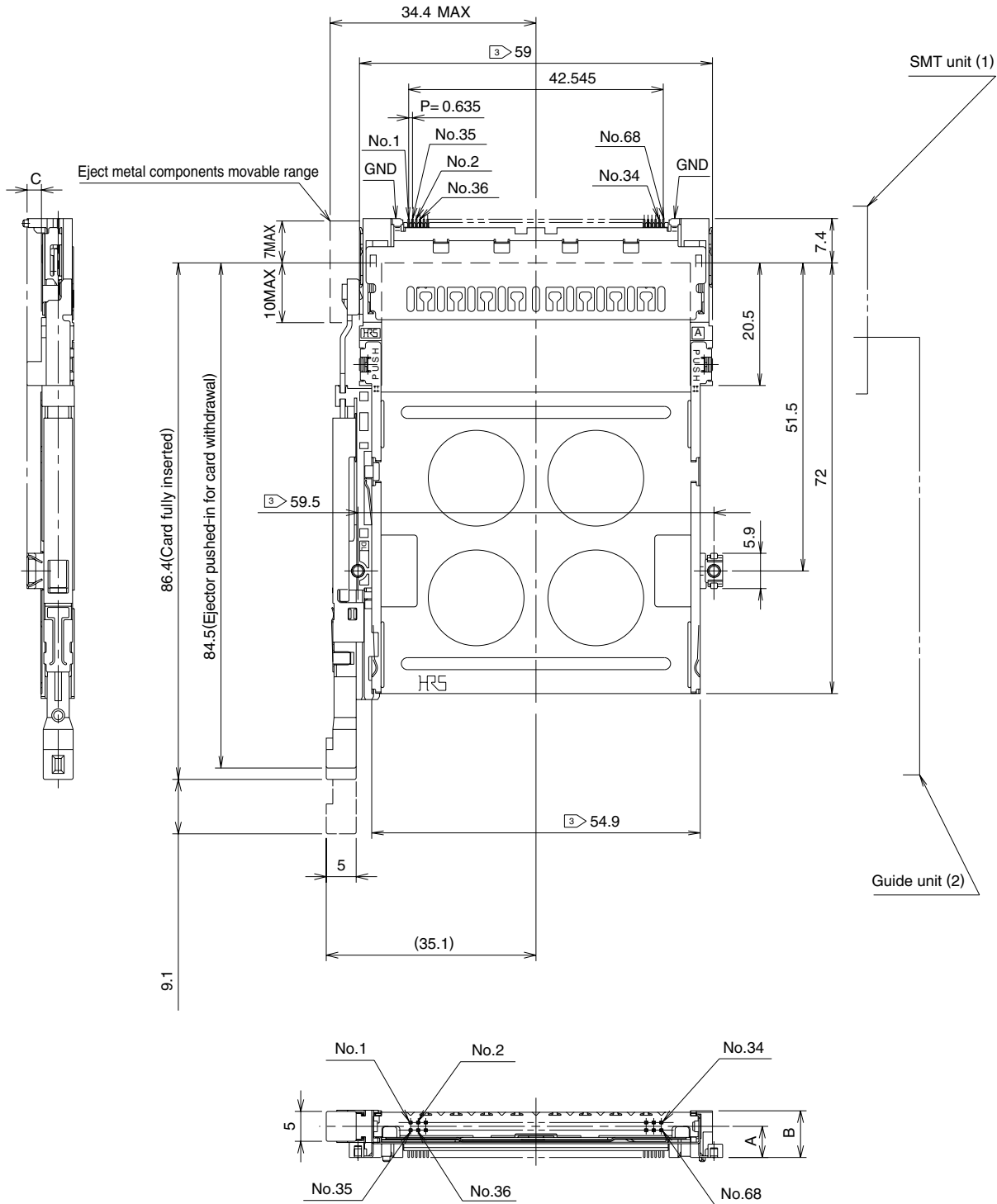

Standoff type	SMT unit ①		Guide unit ②		A (mm)	B (mm)	C (mm)	Weight (g)
	Part Number	CL No.	Part Number	CL No.				
None	IC11S-68PL-1.27SF-EJL	640-1008-6	IC11S-BD-PEJL	640-1082-9	3	5.7	0.1	14.7
2.2mm	IC11SA-68PL-1.27SF-EJL	640-1010-8	IC11SA-BD-PEJL	640-1084-4	5.2	7.9	2.3	15.1

Note 1: All illustrations show the SMT unit (①) and Guide unit (②) assembled.

Note 2: Dimensions for card insertion are in accordance with "PC card standard".

③ : Indicated dimensions are symmetrical to the center of the card insertion slot.

Standard Right Pop-up button (Version 2)

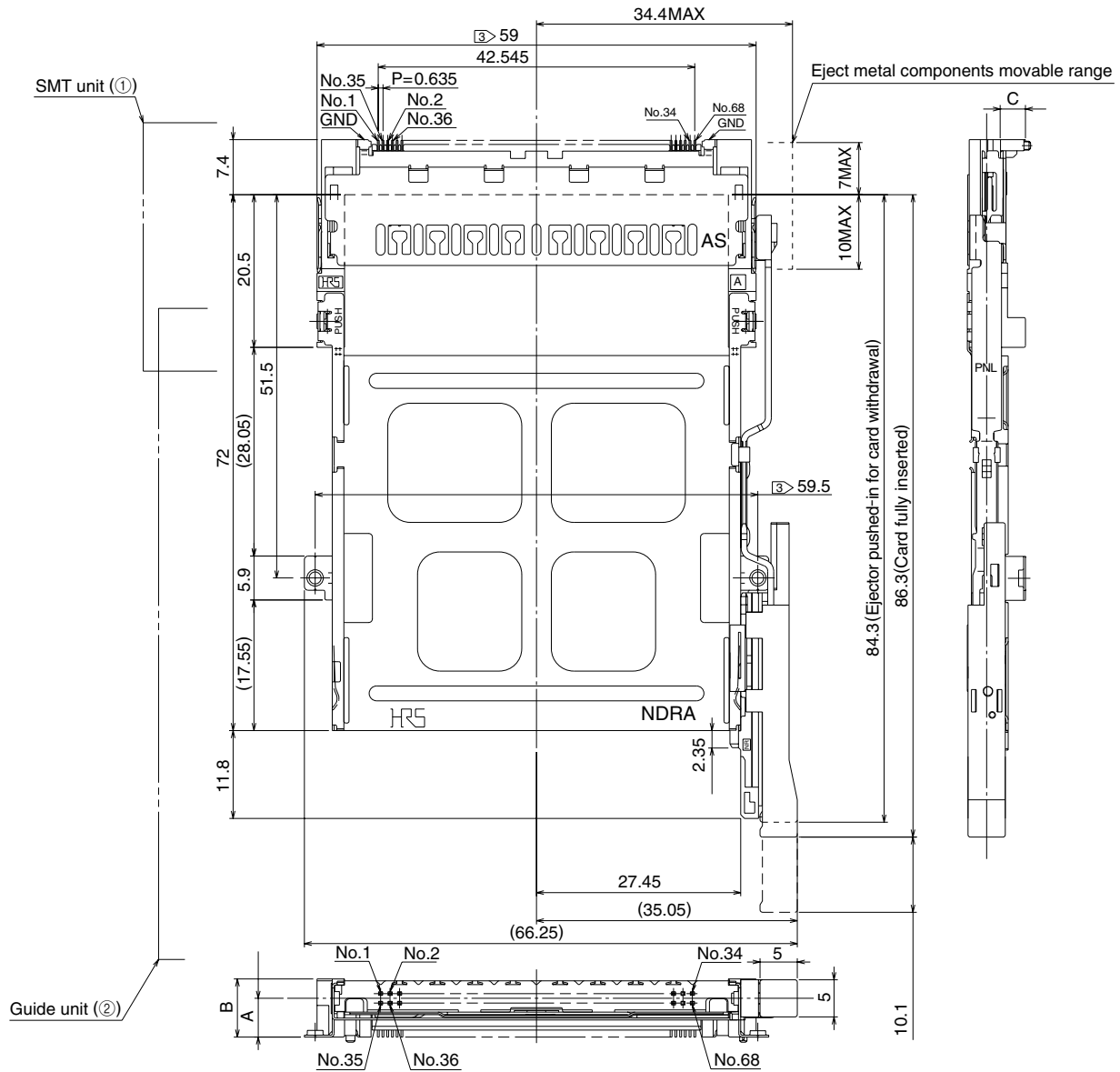

Standoff type	SMT unit ①		Guide unit ②		A (mm)	B (mm)	C (mm)	Weight (g)
	Part Number	CL No.	Part Number	CL No.				
None	IC11S-68PL-1.27SF-EJR	640-1007-3	IC11S-BD-PNEJR	640-1251-4	3	5.6	0.1	13.1
2.2mm	IC11SA-68PL-1.27SF-EJR	640-1009-9	IC11SA-BD-PNEJR	640-1253-0	5.2	7.8	2.3	13.6

Note 1: All illustrations show the SMT unit (①) and Guide unit (②) assembled.

Note 2: Dimensions for card insertion are in accordance with "PC card standard".

③ : Indicated dimensions are symmetrical to the center of the card insertion slot.

Standard Left Pop-up button (Version 2)

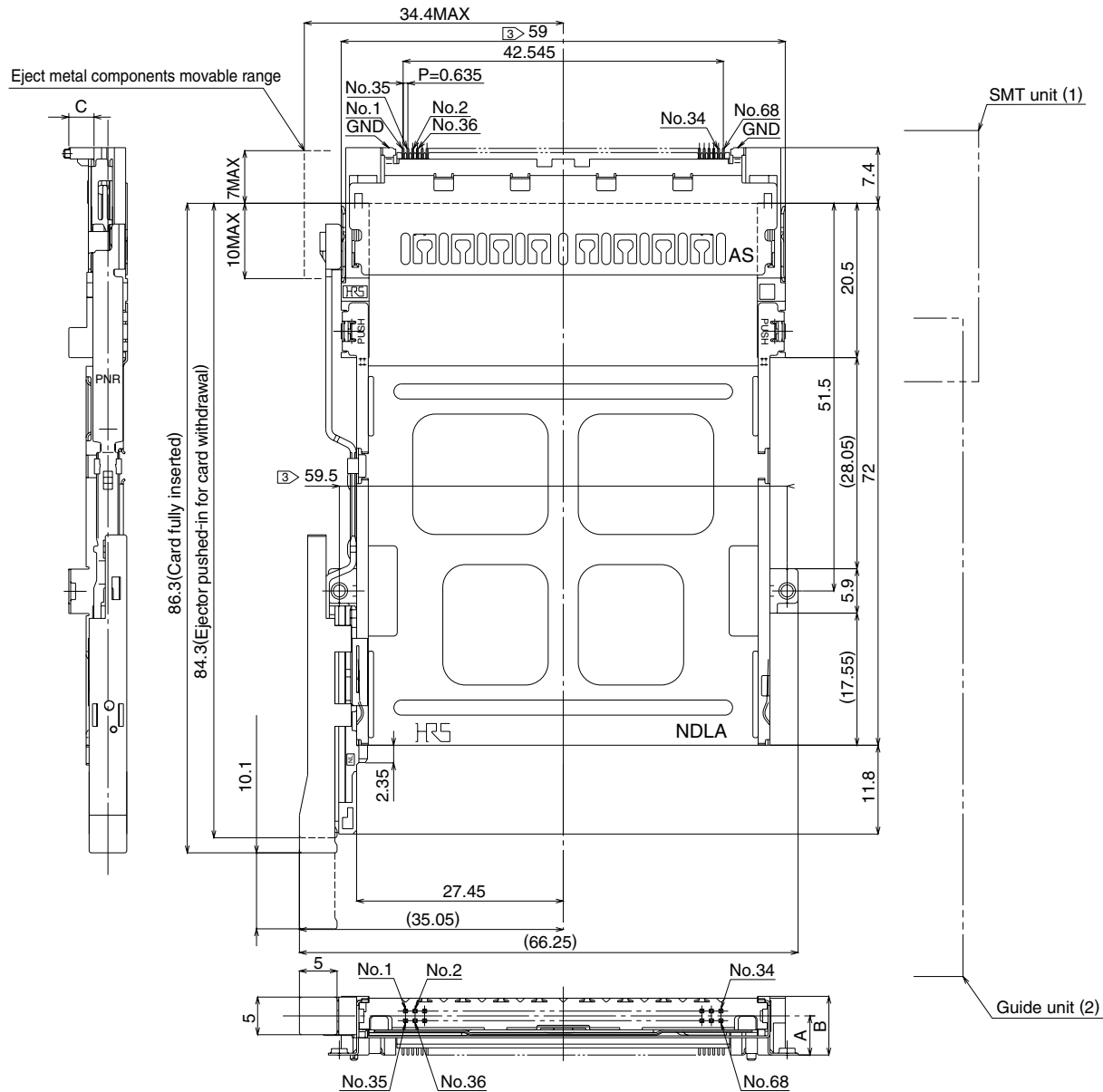

Standoff type	SMT unit ①		Guide unit ②		A (mm)	B (mm)	C (mm)	Weight (g)
	Part Number	CL No.	Part Number	CL No.				
None	IC11S-68PL-1.27SF-EJL	640-1008-6	IC11S-BD-PNEJL	640-1252-7	3	5.6	0.1	13.1
2.2mm	IC11SA-68PL-1.27SF-EJL	640-1010-8	IC11SA-BD-PNEJL	640-1254-2	5.2	7.8	2.3	13.6

Note 1: All illustrations show the SMT unit (①) and Guide unit (②) assembled.

Note 2: Dimensions for card insertion are in accordance with "PC card standard".

③ : Indicated dimensions are symmetrical to the center of the card insertion slot.

Reverse Right rigid button

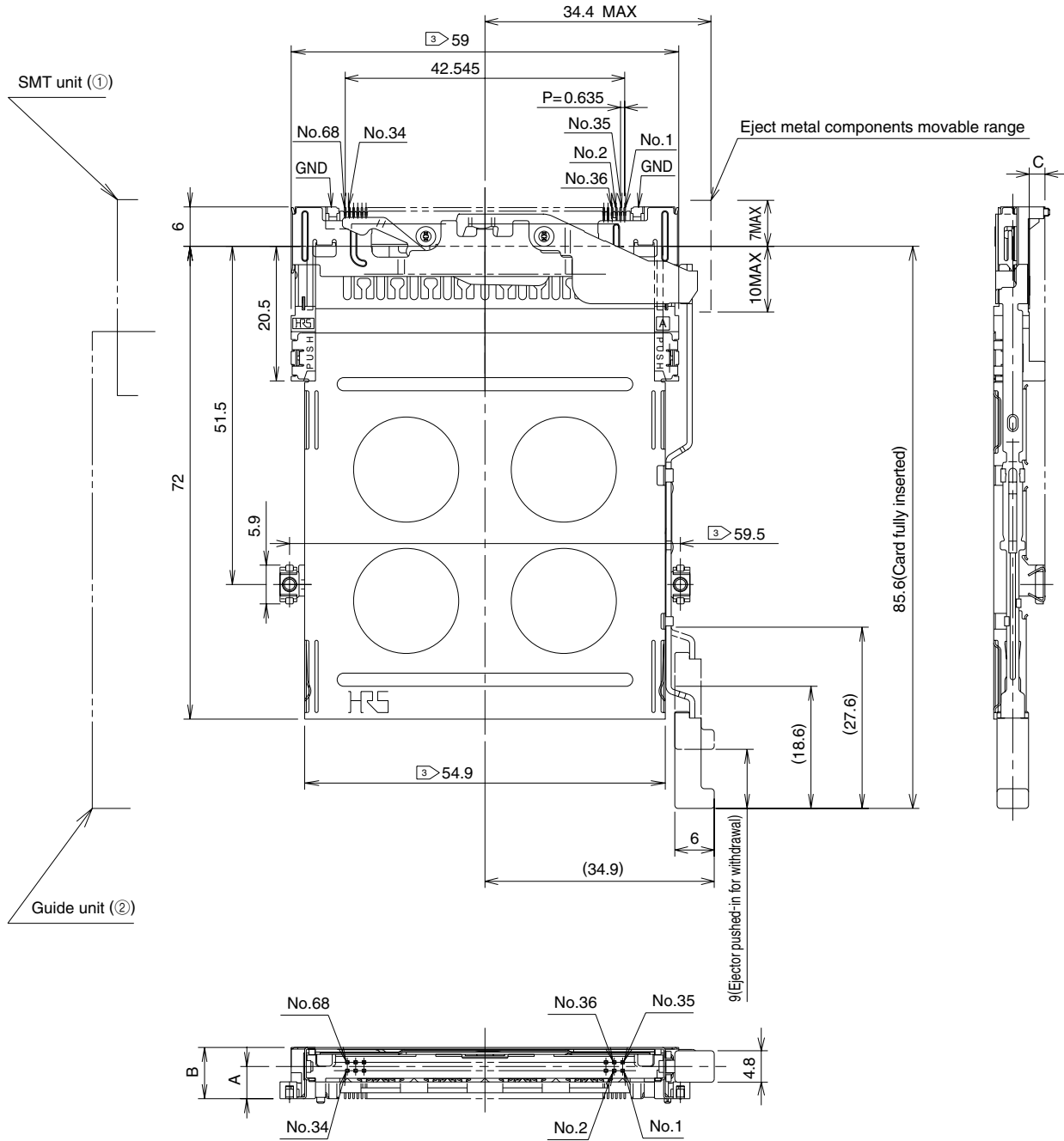

Standoff type	SMT unit ①		Guide unit ②		A (mm)	B (mm)	C (mm)	Weight (g)
	Part Number	CL No.	Part Number	CL No.				
None	IC11S-68PLR-1.27SF-EJR	640-1003-2	IC11S-BUR-EJR	640-1055-6	2.7	5.6	0.1	13.1
2.2mm	IC11SA-68PLR-1.27SF-EJR	640-1005-8	IC11SA-BUR-EJR	640-1057-1	4.9	7.8	2.3	13.6

Note 1: All illustrations show the SMT unit (①) and Guide unit (②) assembled.

Note 2: Dimensions for card insertion are in accordance with "PC card standard".

③ : Indicated dimensions are symmetrical to the center of the card insertion slot.

Reverse Left rigid button

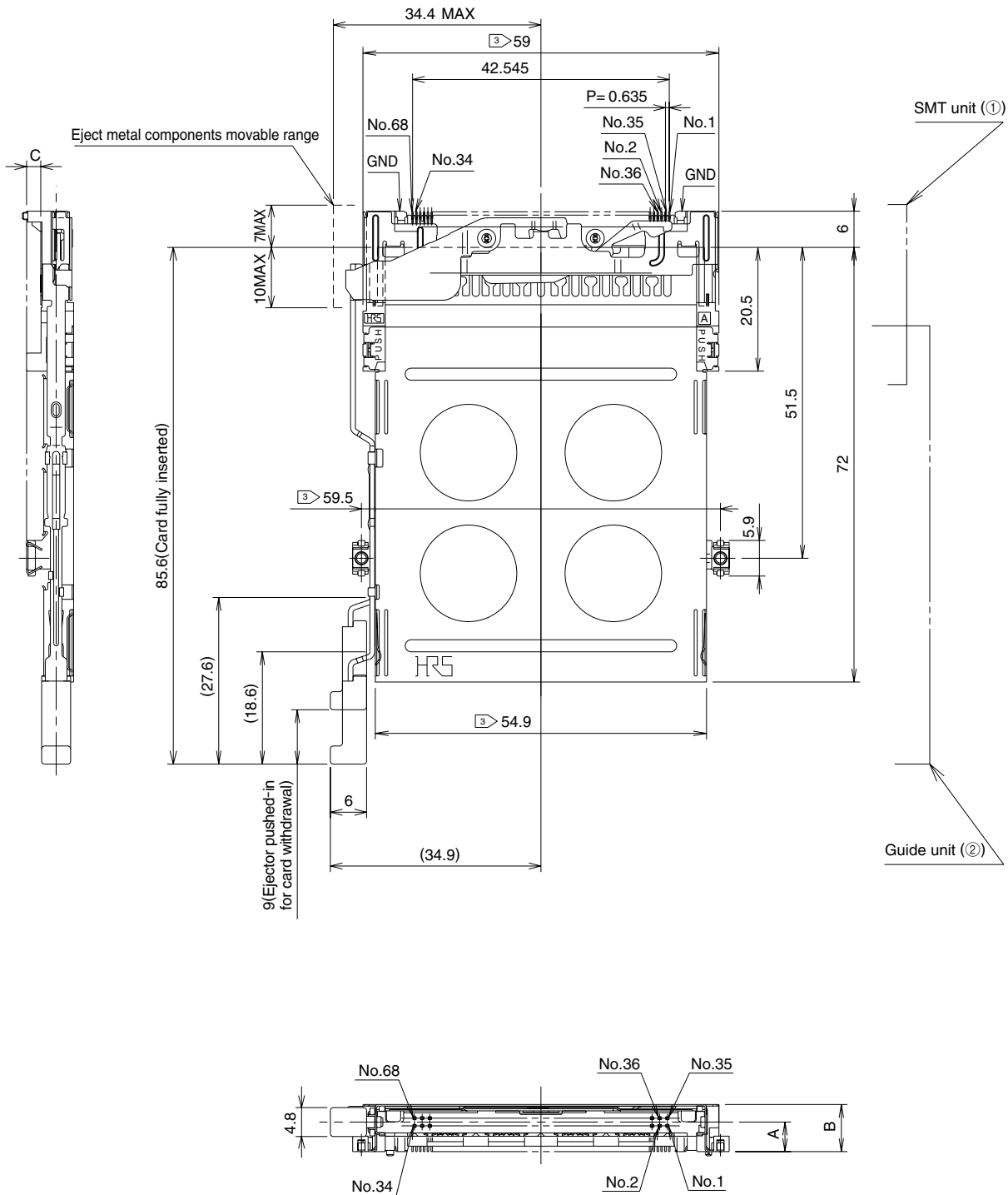

Standoff type	SMT unit ①		Guide unit ②		A (mm)	B (mm)	C (mm)	Weight (g)
	Part Number	CL No.	Part Number	CL No.				
None	IC11S-68PLR-1.27SF-EJL	640-1004-5	IC11S-BUR-EJL	640-1056-9	2.7	5.6	0.1	13.1
2.2mm	IC11SA-68PLR-1.27SF-EJL	640-1006-0	IC11SA-BUR-EJL	640-1058-4	4.9	7.8	2.3	13.6

Note 1: All illustrations show the SMT unit (①) and Guide unit (②) assembled.

Note 2: Dimensions for card insertion are in accordance with "PC card standard".

③ : Indicated dimensions are symmetrical to the center of the card insertion slot.

Reverse

Right folding button

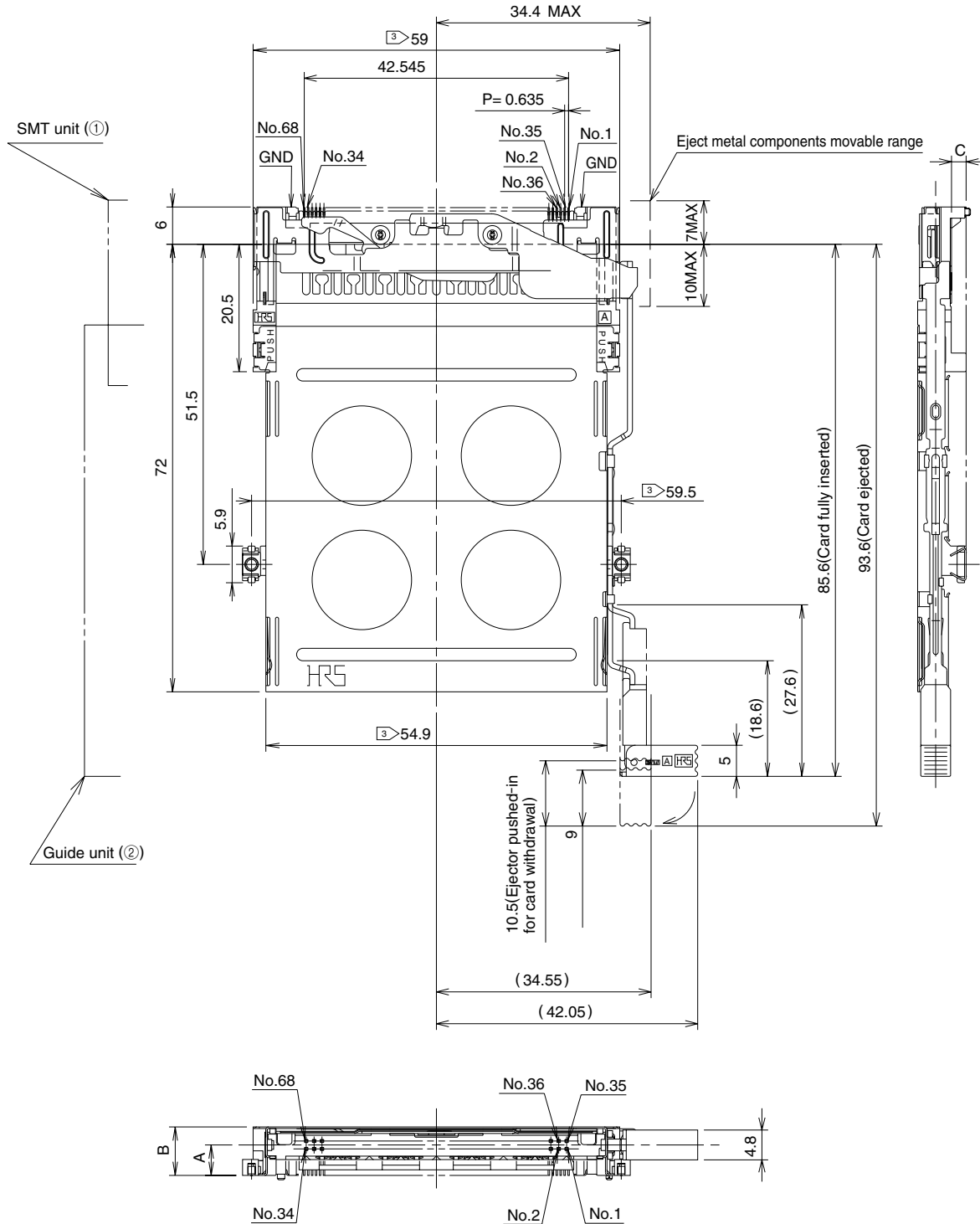

Standoff type	SMT unit ①		Guide unit ②		A (mm)	B (mm)	C (mm)	Weight (g)
	Part Number	CL No.	Part Number	CL No.				
None	IC11S-68PLR-1.27SF-EJR	640-1003-2	IC11S-BUR-FEJR	640-1059-7	2.7	5.6	0.1	13.5
2.2mm	IC11SA-68PLR-1.27SF-EJR	640-1005-8	IC11SA-BUR-FEJR	640-1061-9	4.9	7.8	2.3	14

Note 1: All illustrations show the SMT unit (①) and Guide unit (②) assembled.

Note 2: Dimensions for card insertion are in accordance with "PC card standard".

③ : Indicated dimensions are symmetrical to the center of the card insertion slot.

Reverse

Left folding button

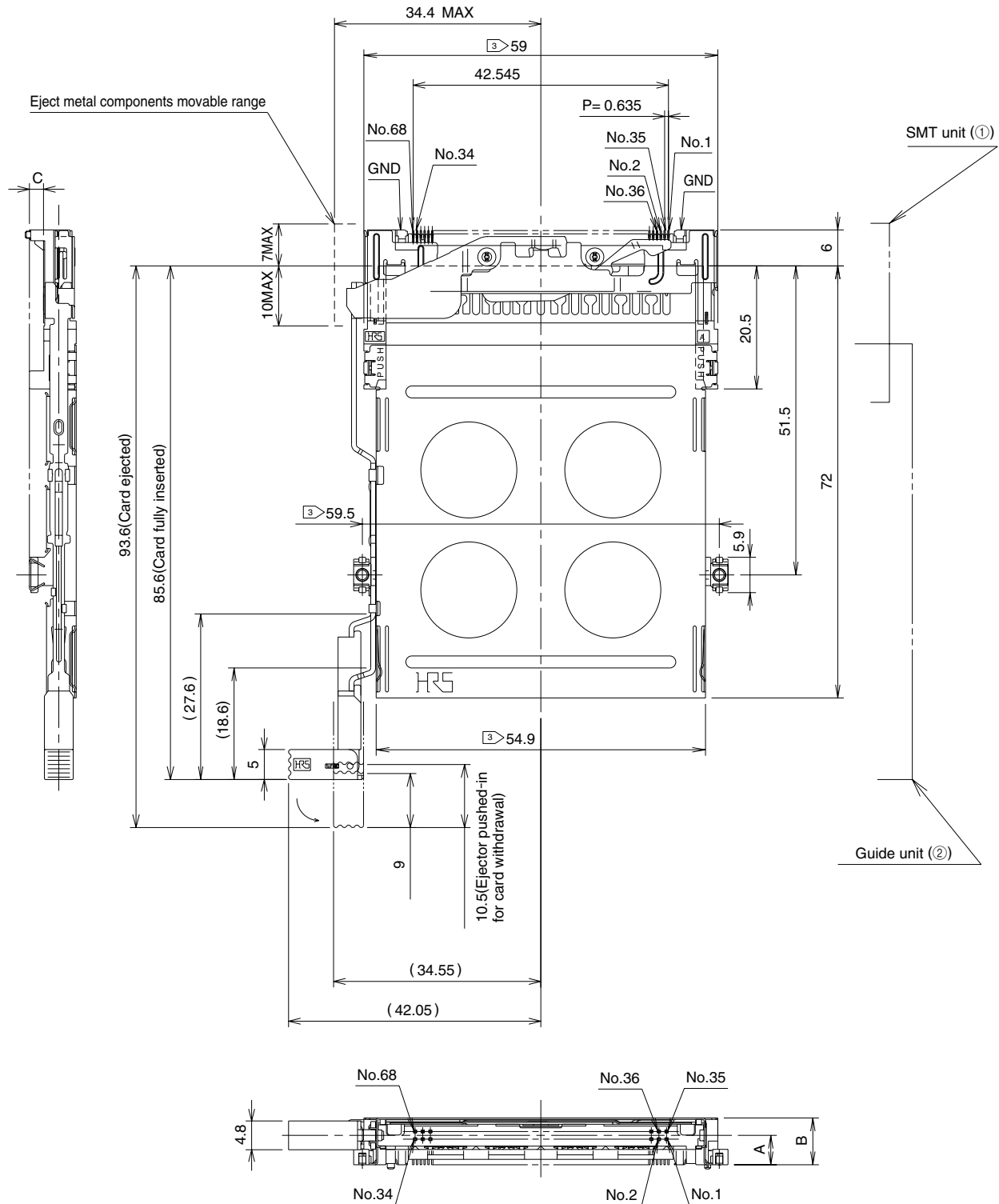

Standoff type	SMT unit ①		Guide unit ②		A (mm)	B (mm)	C (mm)	Weight (g)
	Part Number	CL No.	Part Number	CL No.				
None	IC11S-68PLR-1.27SF-EJL	640-1004-5	IC11S-BUR-FEJL	640-1060-6	2.7	5.6	0.1	13.5
2.2mm	IC11SA-68PLR-1.27SF-EJL	640-1006-0	IC11SA-BUR-FEJL	640-1062-1	4.9	7.8	2.3	14

Note 1: All illustrations show the SMT unit (①) and Guide unit (②) assembled.

Note 2: Dimensions for card insertion are in accordance with "PC card standard".

③ : Indicated dimensions are symmetrical to the center of the card insertion slot.

Reverse

Right Pop-up button (Version 1)

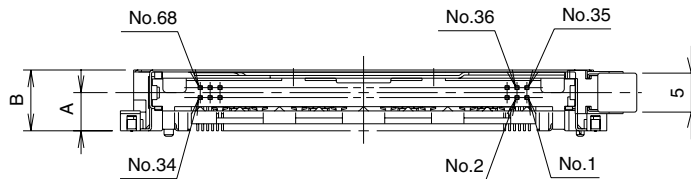
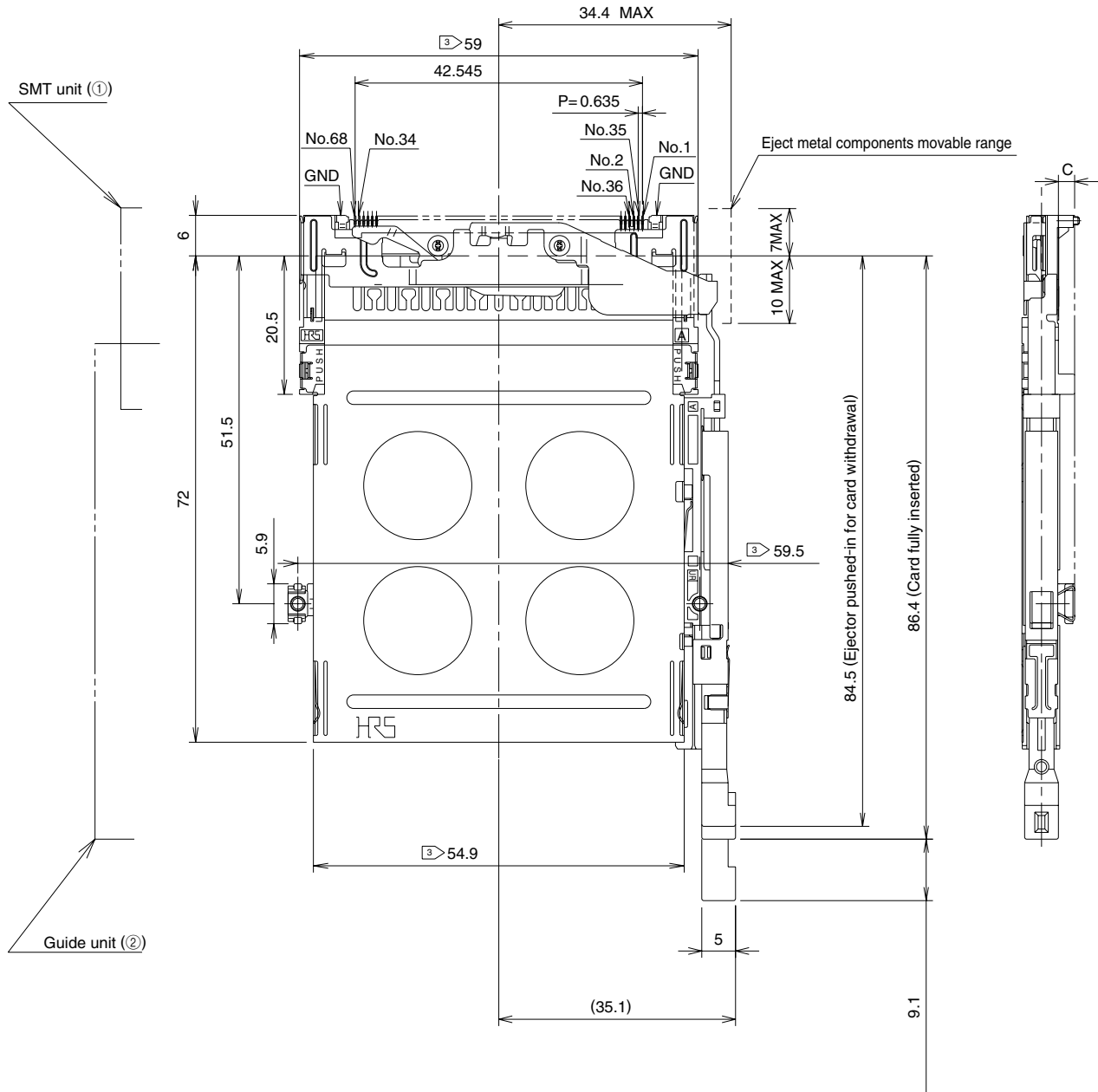

Standoff type	SMT unit ①		Guide unit ②		A (mm)	B (mm)	C (mm)	Weight (g)
	Part Number	CL No.	Part Number	CL No.				
None	IC11S-68PLR-1.27SF-EJR	640-1003-2	IC11S-BUR-PEJR	640-1065-0	2.7	5.6	0.1	15.1
2.2mm	IC11SA-68PLR-1.27SF-EJR	640-1005-8	IC11SA-BUR-PEJR	640-1067-5	4.9	7.8	2.3	15.6

Note 1: All illustrations show the SMT unit (①) and Guide unit (②) assembled.

Note 2: Dimensions for card insertion are in accordance with "PC card standard".

③ : Indicated dimensions are symmetrical to the center of the card insertion slot.

◆PCB mounting pattern

●Standard

●Without Standoff

(Right button)

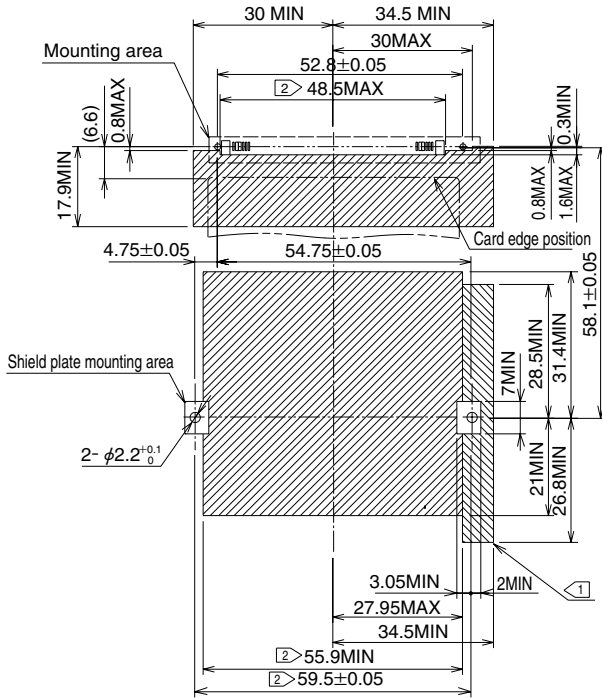

●Without standoff

(left button)

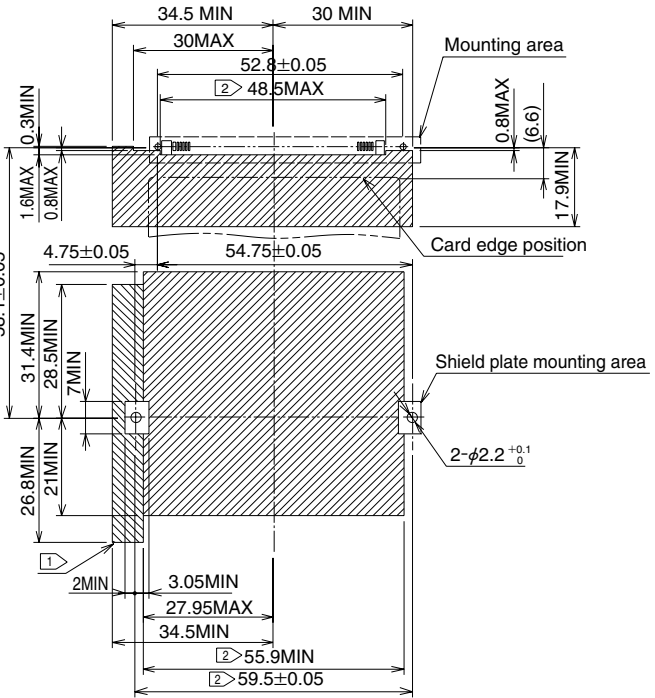

●Standoff 2.2mm

(Common to both Right & left buttons)

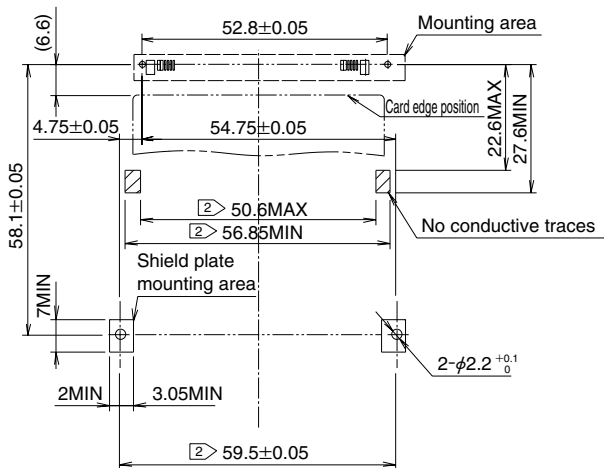

Note1) line pattern indicates conductive pattern prohibition area.

line pattern indicates conductive pattern prohibition area only when the IC11S-BD-PEJ card guide module is used.

Indicated dimensions are symmetrical to the center of the card insertion slot.

◆PCB mounting pattern Pop-up button (Version 2)

●Standard

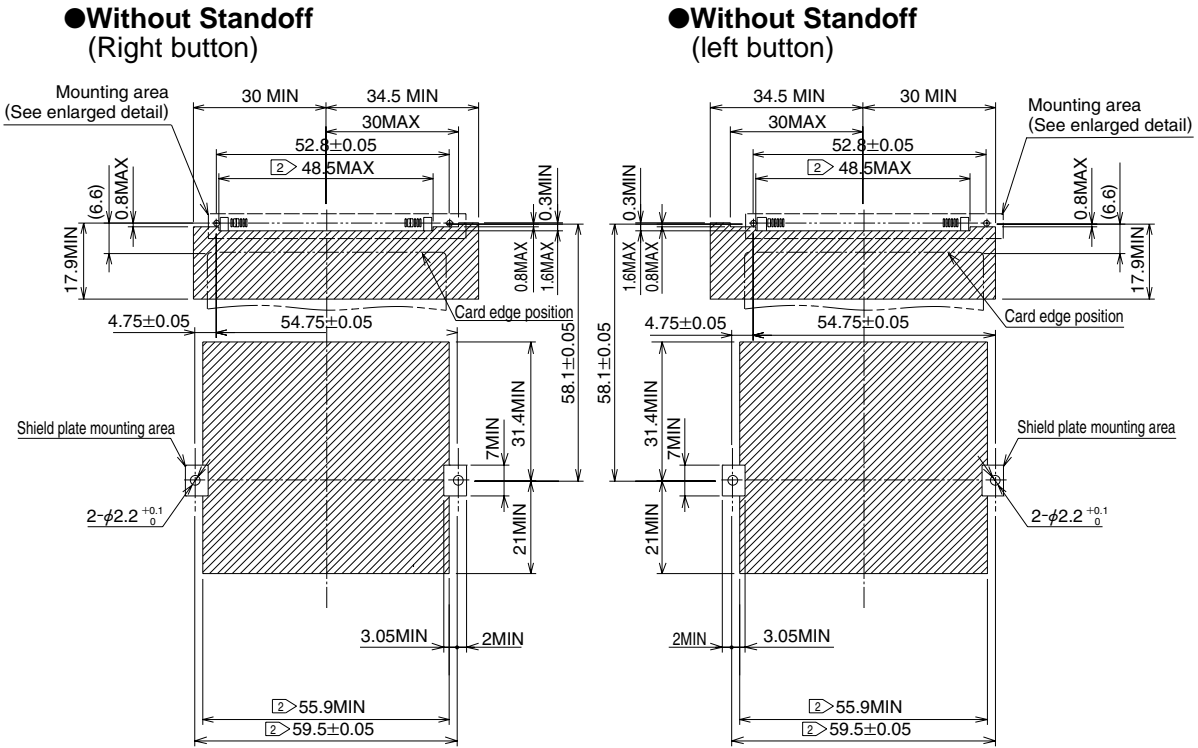

●Standoff 2.2mm (common to both Right and left buttons)

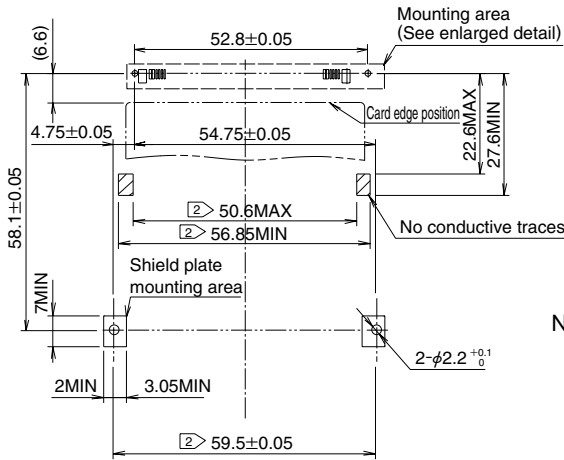

Note1) line pattern indicates conductive pattern prohibition area.
 ②) Indicated dimensions are symmetrical to the center of the card insertion slot..

◆PCB mounting pattern (Enlarged detail)

●Standard

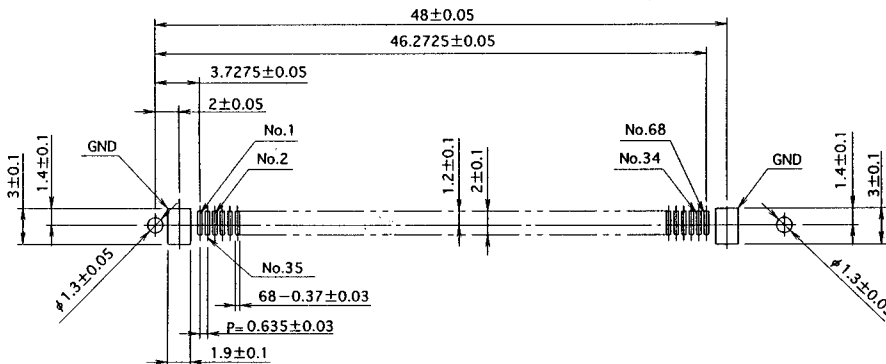

●Reverse

●Without Standoff

(Right button)

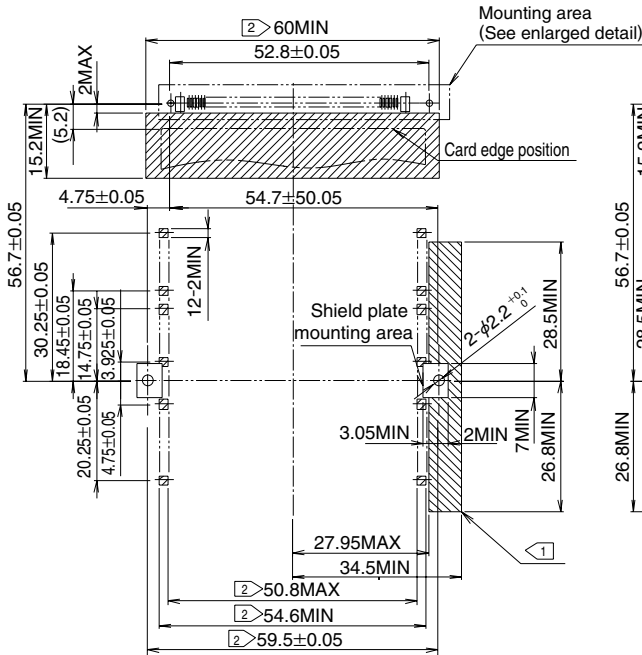

●Without standoff

(left button)

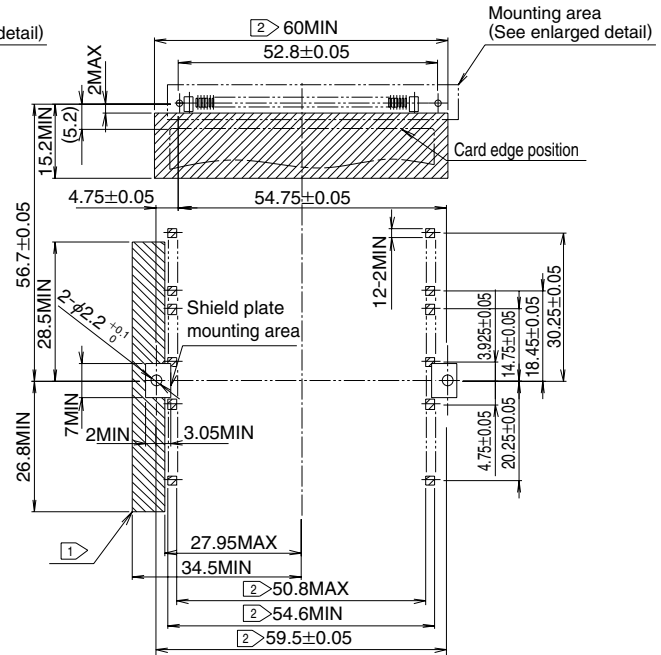

●Standoff 2.2mm

(common to both right and left buttons)

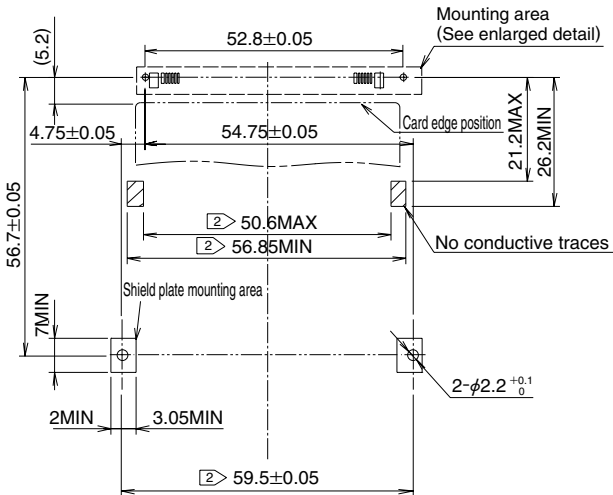

Note1) line pattern indicates conductive pattern prohibition area.

line pattern indicates conductive pattern prohibition area only when the IC11S-BD-PEJ card guide module is used.

Indicated dimensions are symmetrical to the center of the card insertion slot.

Pop-up button (Version 2)

● Reverse

● Without Standoff

(Common to both Right & left buttons)

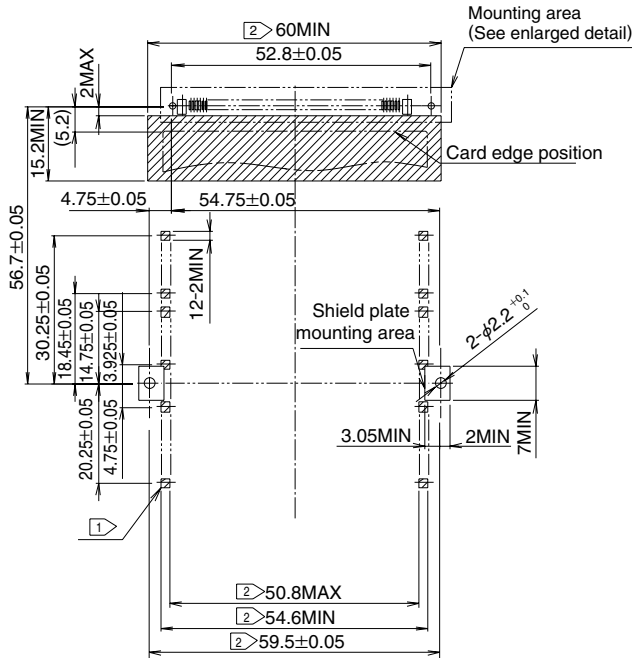

● Standoff 2.2mm

(common to both right and left buttons)

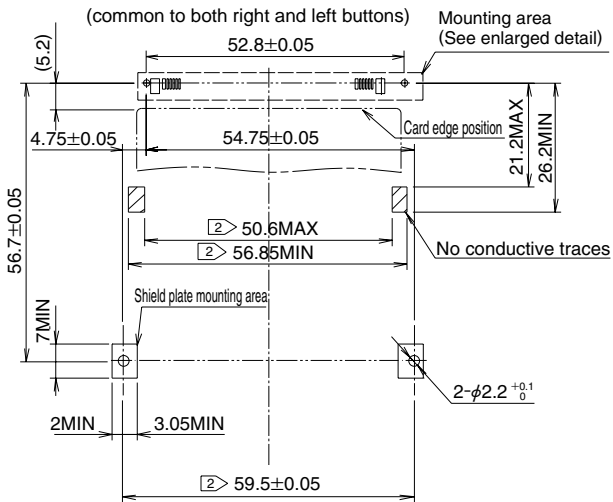

Note1) line pattern indicates conductive pattern prohibition area.
) Indicated dimensions are symmetrical to the center of the card insertion slot..

◆ PCB mounting pattern (Enlarged detail)

● Reverse

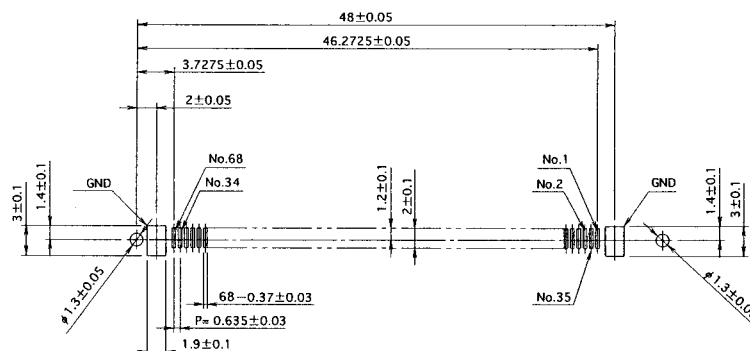

◆ Installation on the Board (Standard type)

(1) Mount the SMT unit on the board

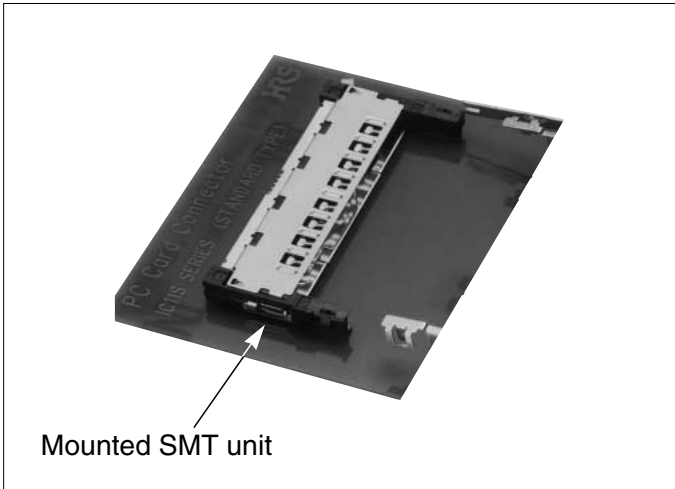

(2) Align the locking tab on the Guide unit over the opening on the SMT unit

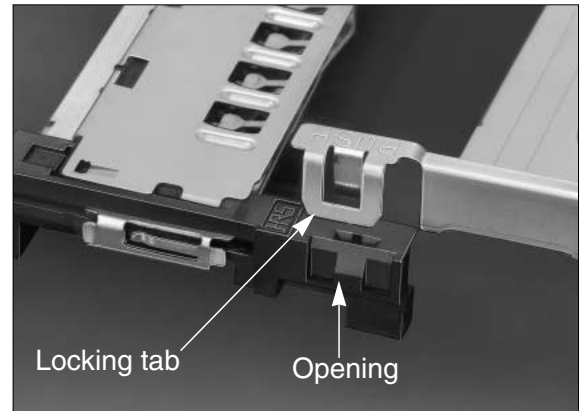
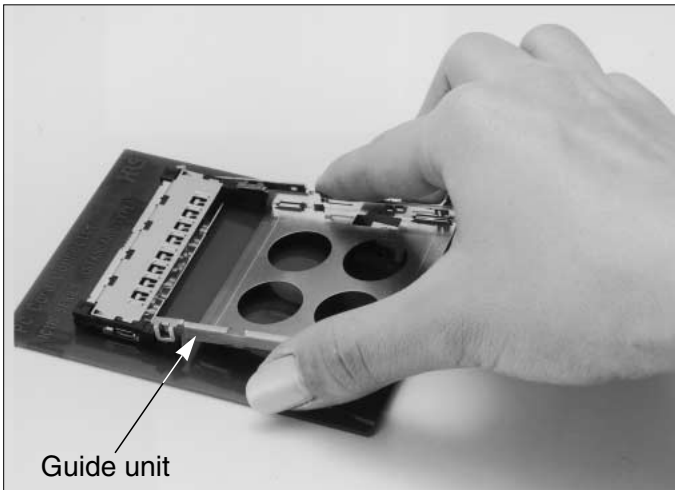

(3) Holding the Guide unit as shown press it firmly down until both parts are securely locked together. Audible “click” will be heard.

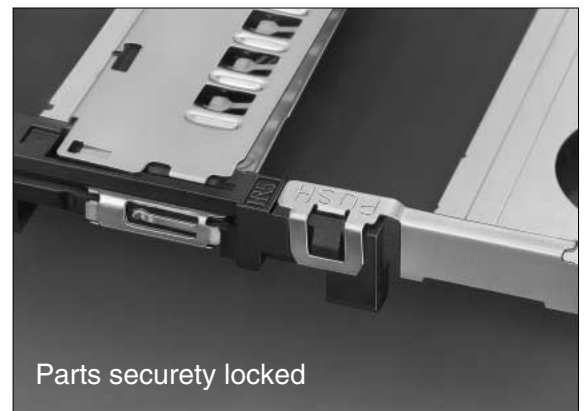
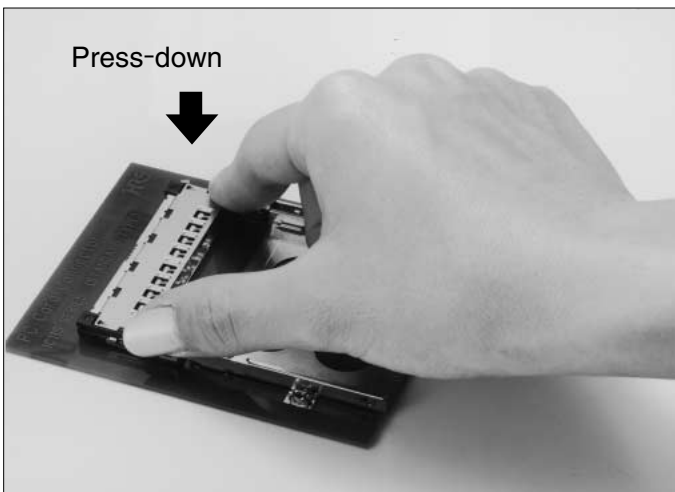

Note: To avoid damage or deformation of parts, DO NOT apply pressure at any other area.

(4) Use screws to fasten the guide unit at two places from the bottom of the board.

Screw size	Pitch	Recommended Torque
M2	0.4	0.14 ~ 0.18 (N · m)

◆ Installation on the Board (Reverse type)

(1) Mount the SMT unit on the board

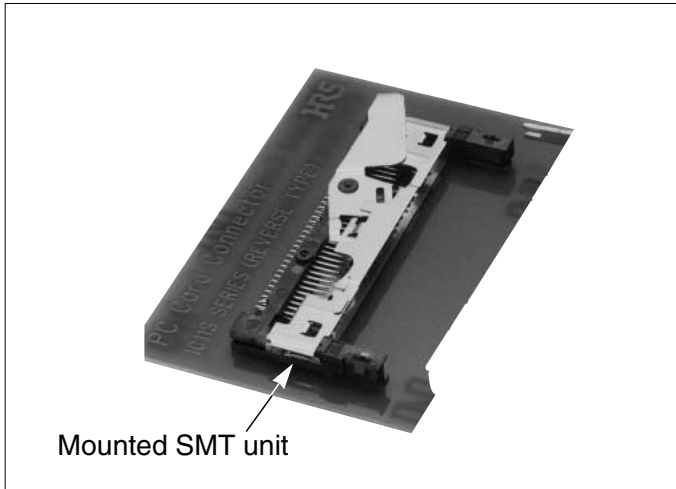

(2) Align the locking tab on the Guide unit over the opening on the SMT unit

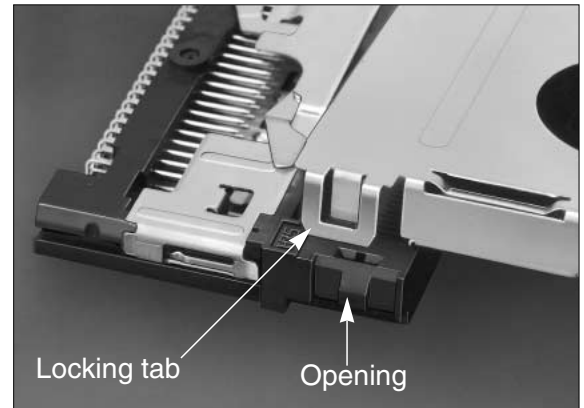
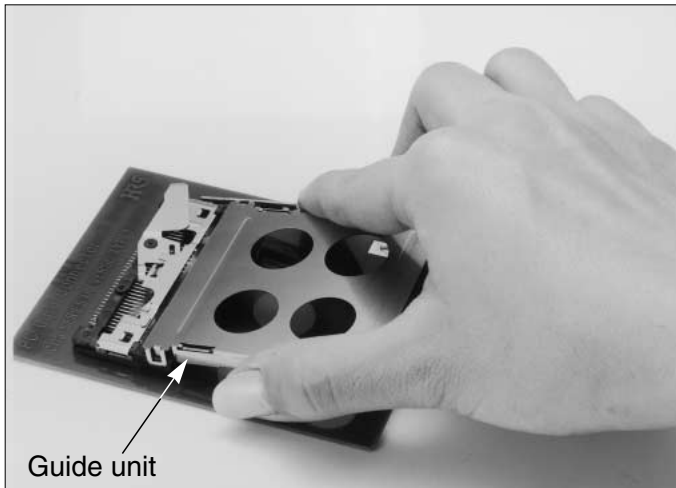

(3) Holding the Guide unit as shown press it firmly down until both parts are securely locked together. Audible “click” will be heard.

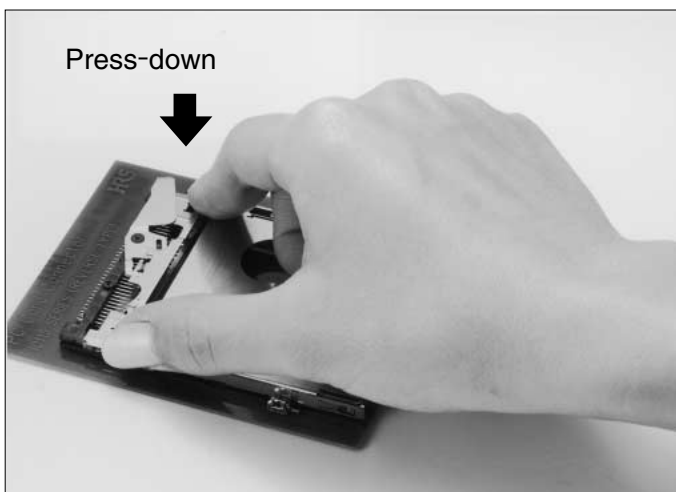

Note: To avoid damage or deformation of parts, DO NOT apply pressure at any other area.

(4) Use screws to fasten the guide unit at two places from the bottom of the board.

Screw size	Pitch	Recommended Torque
M2	0.4	0.14 ~ 0.18 (N · m)

◆Precautionary installation notes

1. Make sure that the position of the stroke arm (on the SMT unit) and the push rod (on the Guide unit) are in positions as shown on the photograph below (as delivered).
2. Should they be in other positions, move them into correct one.
3. Metal components of these connector assemblies have sharp edges. Use caution when handling, installing or disassembling.
4. Solder reflow operation cannot be performed with the Guide unit installed.

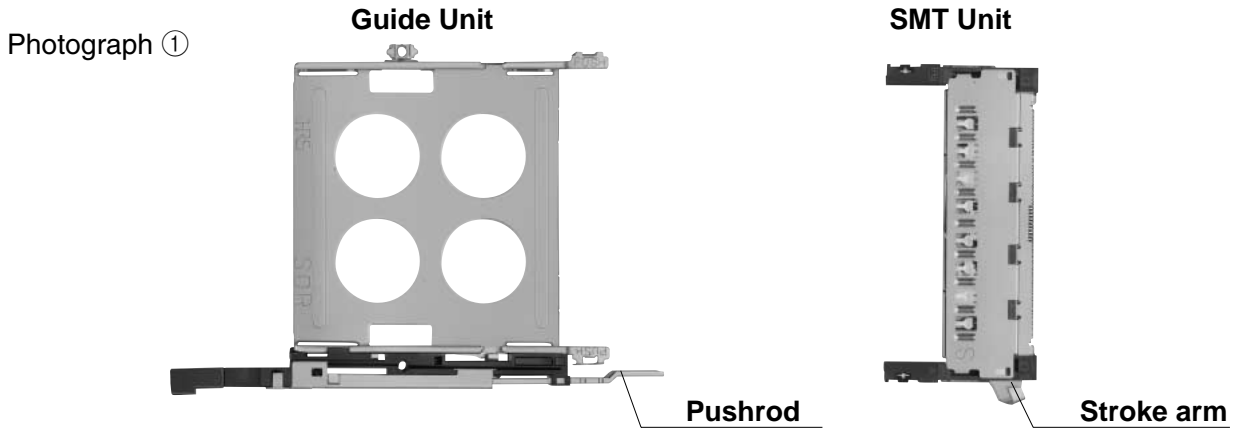

After assembling the SMT unit and the guide unit, they will appear as shown below.

- Push rod and stroke arm connected
(Card to be inserted)

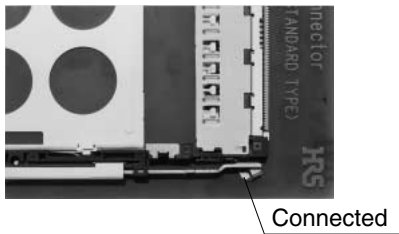

- Push rod and stroke arm connected
(Card ready for ejection)

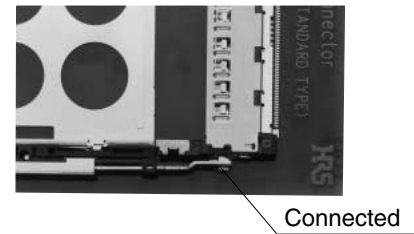

◆ Recommended temperature profile

● Common to lead-free solder paste

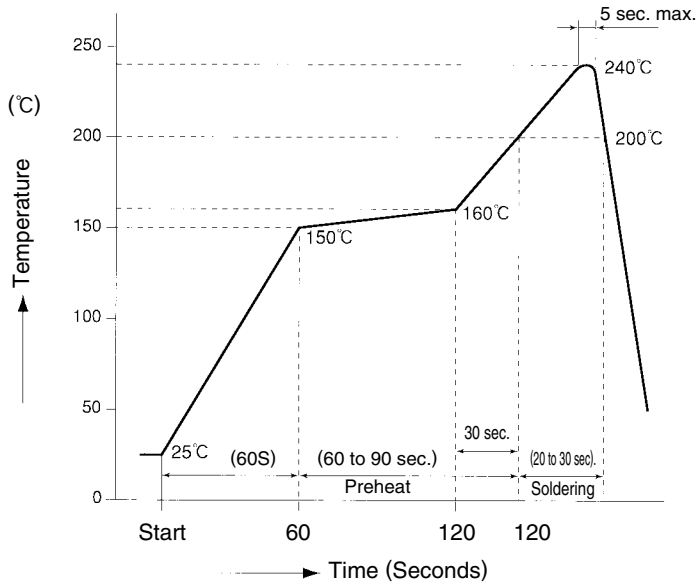

<Recommended conditions>

Reflow system	: IR reflow
Solder composition	: Paste, 63%Sn/37%Pb (Flux content 9wt%)
Test board	: Glass epoxy 80mm×125mm×1.6mm thick
Metal mask	: 0.15mm thick

The temperature profiles are based on the above conditions.

In individual applications the actual temperature may vary, depending on solder paste type, volume/thickness and board size/thickness. Consult your solder paste and equipment manufacturer for specific recommendations.