

DATE DRAWN BY: S.M. BROWN
 DESIGNED BY: S.M. BROWN
 CHECKED BY: S.M. BROWN
 APPROVED BY: S.M. BROWN

REV. NO.		DESCRIPTION		DATE	BY	APP'D
0	1	RELEASED PER 6312-0630-04				

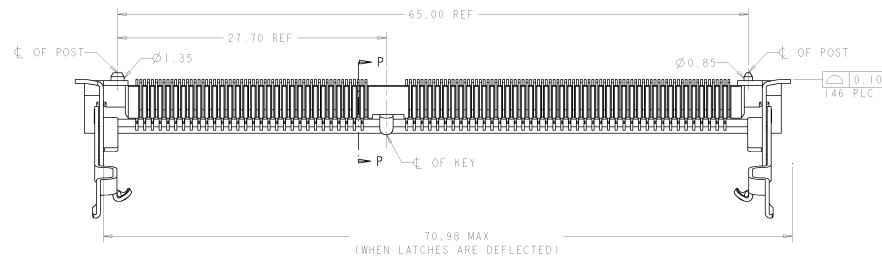

- △ MATERIAL: HOUSING: HIGH TEMPERATURE PLASTIC - NATURAL
 LATCHES: STAINLESS STEEL UNS S30100
 CONTACTS: PHOSPHOROUS BRONZE
 SOLDER LEADS: PHOSPHOROUS BRONZE
- △ FINISH: SOLDER LEADS: GOLD 0.00025 MIN IN CONTACT AREA
 ALL OVER 0.00130 MIN THICK NICKEL
 LATCHES: MATTE TIN 0.0025 MIN OVER
 NICKEL 0.00130 MIN.
- △ MODULE BOARD PAD FINISH: FOR OPTIMUM PERFORMANCE
 SMOOTH AND FLAT
 0.00075 MIN THICK GOLD OVER
 0.00200 MIN THICK NICKEL.

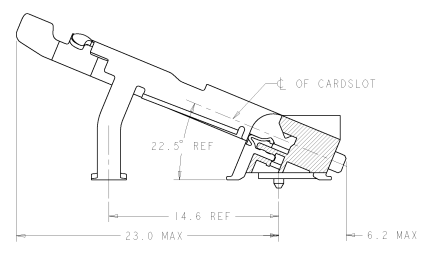
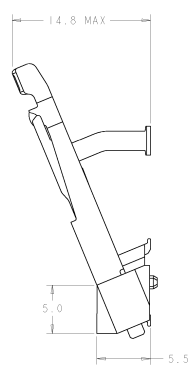
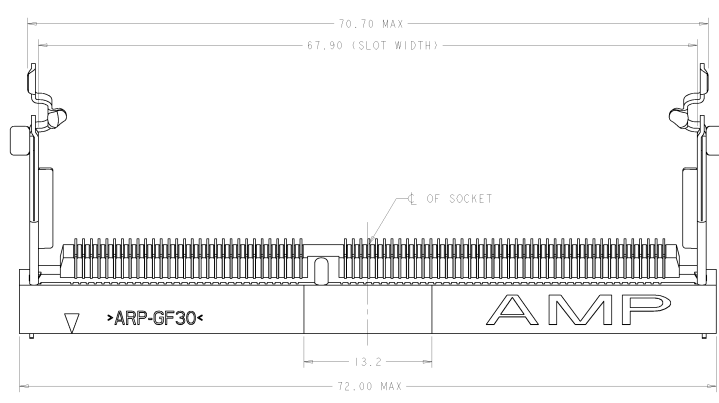

SECTION P-P
 SCALE 6:1

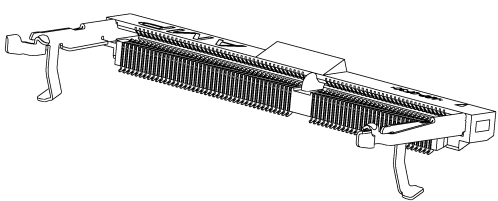

DRAM 3.3V	144	6368063-1
POWER SUPPLY	POSN	PART NUMBER

MATERIAL		FINISH		TOLERANCES		SURFACE FINISH		MATERIAL	
PLC	146	PLC	146	PLC	146	PLC	146	PLC	146
AMP Incorporated	AMP Incorporated	AMP Incorporated	AMP Incorporated	AMP Incorporated	AMP Incorporated	AMP Incorporated	AMP Incorporated	AMP Incorporated	AMP Incorporated

REV	DATE	DESCRIPTION	BY	CHK	APP
0		REVISIONS			
1		SEE SHEET 1			

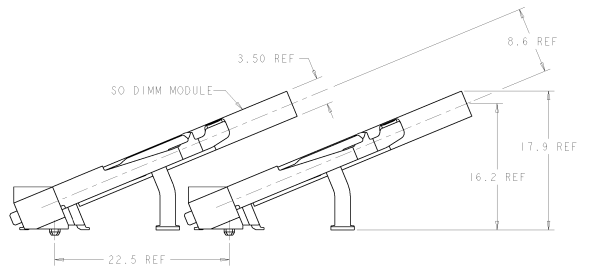
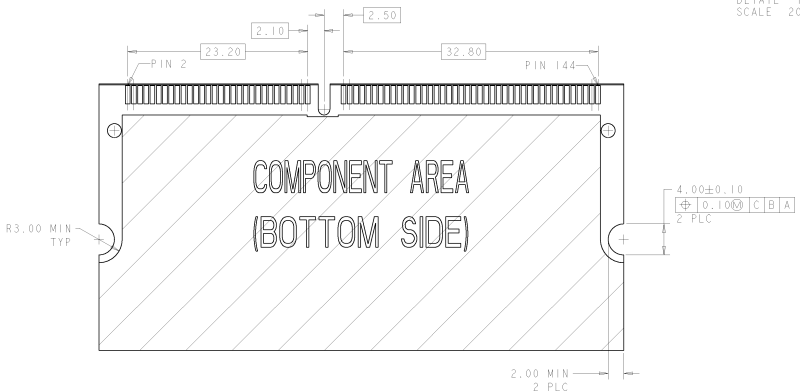
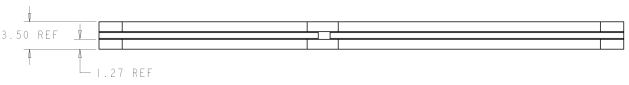
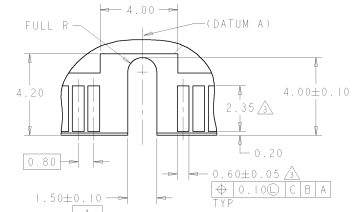
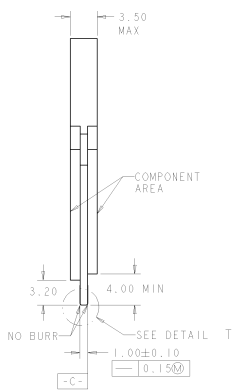
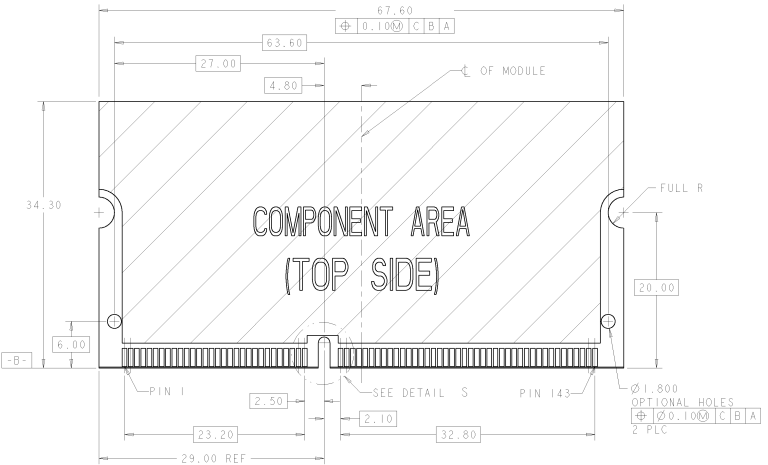

MFG: TONY ELECTRONICS CORPORATION PART: SO DIMM MODULE REV: 0 DATE: 12/15/2010	MFG: TONY ELECTRONICS CORPORATION PART: SO DIMM MODULE REV: 0 DATE: 12/15/2010	MFG: TONY ELECTRONICS CORPORATION PART: SO DIMM MODULE REV: 0 DATE: 12/15/2010	Tyco ANGELED S.O. DIMM SOCKET ASSEMBLY 0.8mm PITCH 144 POSN, 22.5 DEGREES TILT FOR DRAM TYPE MODULE	MFG: TONY ELECTRONICS CORPORATION PART: SO DIMM MODULE REV: 0 DATE: 12/15/2010
---	---	---	---	---

DATE: 08/20/2003
 BY: [signature]
 P.C. BOARD OUTLINE

REV	DATE	DESCRIPTION	BY	CHK	APP
0		REVISIONS			
		DESCRIPTION			
		DATE			
		BY			
		CHK			
		APP			

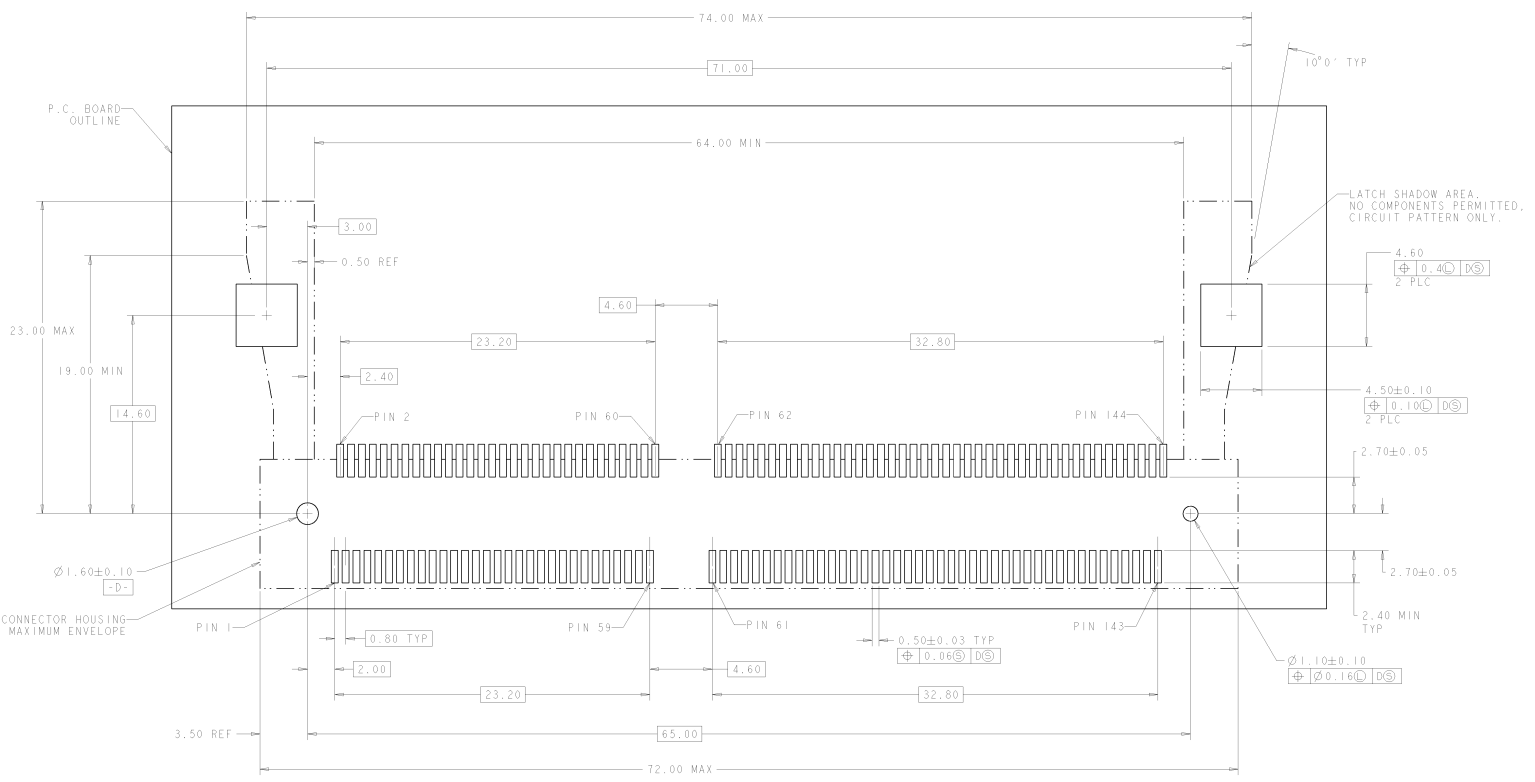

RECOMMENDED MOTHERBOARD FOOTPRINT
 SCALE 7:1

REV	DATE	DESCRIPTION	BY	CHK	APP
0		REVISIONS			
		DESCRIPTION			
		DATE			
		BY			
		CHK			
		APP			

REV	DATE	DESCRIPTION	BY	CHK	APP
0		REVISIONS			
		DESCRIPTION			
		DATE			
		BY			
		CHK			
		APP			

REV	DATE	DESCRIPTION	BY	CHK	APP
0		REVISIONS			
		DESCRIPTION			
		DATE			
		BY			
		CHK			
		APP			