

### C702A Landing Contact Full Smart Card Connectors

The Landing Contacts ensure a rugged construction that will not scratch the card surface simultaneously offering high durability.

#### Electrical

Contact resistance - < 100 mΩ  
 Switch resistance - < 200 mΩ  
 Insulation - > 10<sup>9</sup> Ω  
 High Voltage resistance - 500VAC 1 min  
 Unlock Solenoid PUSHMATIC Only  
 Rated Voltage/Current Use - 5V/2.5A ± 10%  
 - 12V/1.1A ± 10%  
 - 24V/0.55A ± 10%

Current pulse length - 10... 25ms  
 Pulse break - > 0.5s

#### Environmental

Temperature - -25°C thru 85°C  
 Vibration - IEC 60512-4, Test 6d  
 Shock - IEC 60512-4, Test 6c  
 PUSHMATIC with Shutter  
 Degree of Protection - IP 30 (no card)  
 - IP 20 (card inserted)

#### Switch

Normally open.  
 Switch activates after data contacts mate.  
 Chatter time - < 5 ms

#### Durability

Push Only - 5 x 10<sup>5</sup> Cycles  
 Push-Push - 5 x 10<sup>5</sup> Cycles  
 Push-Pull - 5 x 10<sup>5</sup> Cycles  
 PUSHMATIC - 3 x 10<sup>5</sup> Cycles

Part Number:	Description	Chip	Diagram
C702 10M008 018 2	Push Only	ISO	Fig 1
C702 10M008 015 2	Push-Push	ISO	Fig 3
C702 10M008 514 2	Push-Pull	ISO Std	Fig 2
C702 10M008 522 2	Push-Pull	AFNOR	Fig 2
C702 10M008 521 2	Push-Pull	ISO+AFNOR (S)	Fig 2
C702 10M008 523 2	Push-Pull	ISO+AFNOR (P)	Fig 2
C702 10M008 701 2	PUSHMATIC 5V	ISO Std	Fig 4 (Typical)
C702 10M008 700 2	PUSHMATIC 12V	ISO Std	Fig 4 (Typical)
C702 10M008 702 2	PUSHMATIC 24V	ISO Std	Fig 4 (Typical)
C702 10M008 703 2	PUSHMATIC 5V	ISO+AFNOR (S)	Fig 4 (Typical)
C702 10M008 704 2	PUSHMATIC 12V	ISO+AFNOR (S)	Fig 4 (Typical)
C702 10M008 705 2	PUSHMATIC 24V	ISO+AFNOR (S)	Fig 4 (Typical)
C702 10M008 706 2	PUSHMATIC 5V	ISO+AFNOR (P)	Fig 4 (Typical)
C702 10M008 707 2	PUSHMATIC 12V	ISO+AFNOR (P)	Fig 4 (Typical)
C702 10M008 708 2	PUSHMATIC 24V	ISO+AFNOR (P)	Fig 4 (Typical)
C702 10M008 732 2	PUSHMATIC* 5V	ISO	Fig 4 (Typical)
C702 10M008 716 2	PUSHMATIC* 12V	ISO	Fig 4 (Typical)
C702 10M008 727 2	PUSHMATIC* 24V	ISO	Fig 4 (Typical)
C702 20M008 701 2	PUSHMATIC** 5V	ISO	Fig 4 (Typical)
C702 20M008 700 2	PUSHMATIC** 12V	ISO	Fig 4 (Typical)
C702 20M008 702 2	PUSHMATIC** 24V	ISO	Fig 4 (Typical)

**Push Only** – Manual insertion, held in position by hand. Ideal for short cycle transactions.  
**Push-Push** – Manual insertion, card held by reader, second push releases card.  
**Push-Pull** – Manual insertion, card held by reader, card manually extracted.  
**PUSHMATIC** – Manual insertion, card automatically ejected on completion of transaction.  
**\*PUSHMATIC with Locking Detector** – Senses complete insertion of card. Card is still visible but not accessible. Automatic card release on completion of transaction.  
**\*\*PUSHMATIC with Shutter** (additional Bezel is NOT required) – The Shutter protects the card slot when no card is present. The Shutter will only open upon insertion of a standard sized card.  
 (S) – Cable in Series (P) – Cable in Parallel

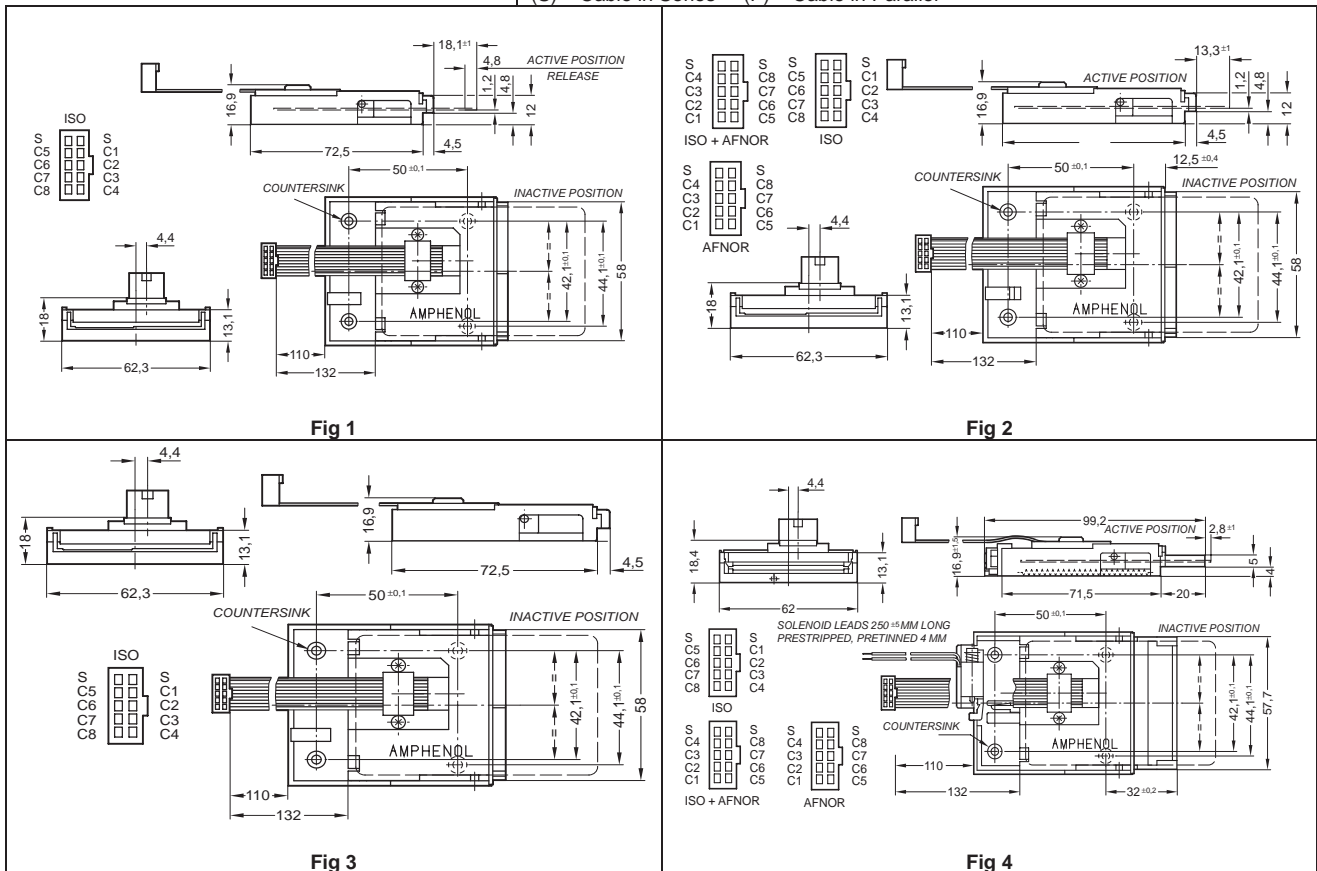

ATE

# Amphenol

## Card Readers

### C702F Landing Card Full Smart Card Reader

PCB Mount card reader with stationary contacts. Mechanism lands Smart Card onto contacts. Card insertion depth is short.

#### Electrical

Contact resistance - < 35 mΩ  
 Switch contacts - < 70 mΩ  
 Insulation - > 10<sup>9</sup> Ω  
 High Voltage resistance - 500VAC 1 min

#### Environmental

Temperature - -25°C thru 85°C  
 Vibration - IEC 60512-4, Test 6d  
 Shock - IEC 60512-4, Test 6c

#### Switch

Normally open.  
 Switch activates after data contacts mate.  
 Chatter time - < 5 ms

#### Mechanical

Card Insertion Force - ≤ 12N  
 Card Extraction Force - ≥ 2.5N  
 Durability - 3x10<sup>5</sup> Cycles

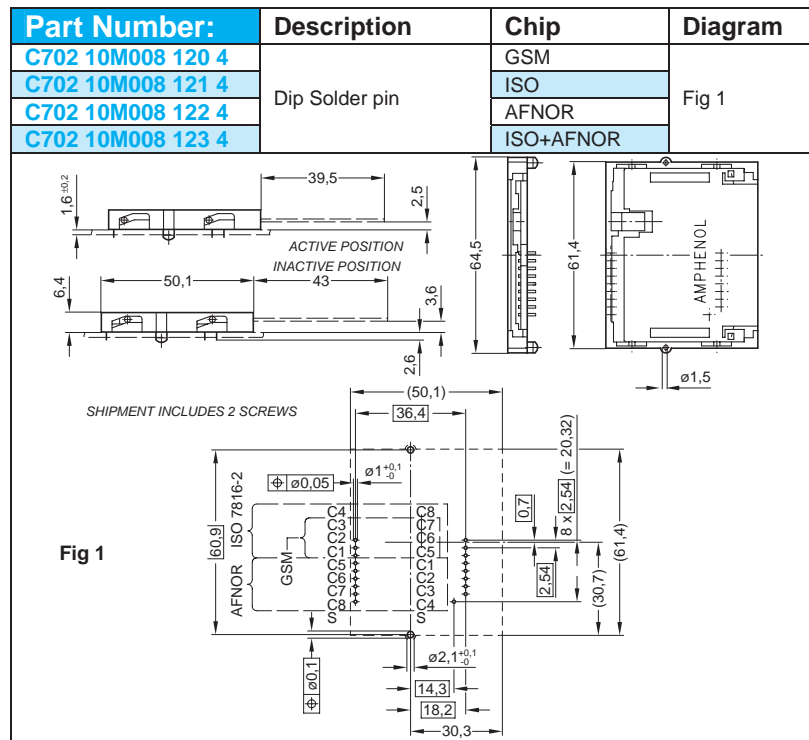

### C705A Disk Drive Slot Full Smart Card Reader

Push-Pull smart card reader mount into a Disk Drive housing for PC applications

#### Characteristics

Card Reader Type - C702A  
 Colour - Tan  
 LED - Bicolour red/green

Part Number:	Description	Chip	Diagram
C705 10M008 005 5	Disk Drive Slot 3 1/2" Tower	ISO	Fig 2
C705 10M008 019 5	Disk Drive Slot 3 1/2" DeskTop	ISO	Fig 2
C705 10M008 006 5	Disk Drive Slot 5 1/4" Tower	ISO	Fig 3
C705 10M008 020 5	Disk Drive Slot 5 1/4" DeskTop	ISO	Fig 3

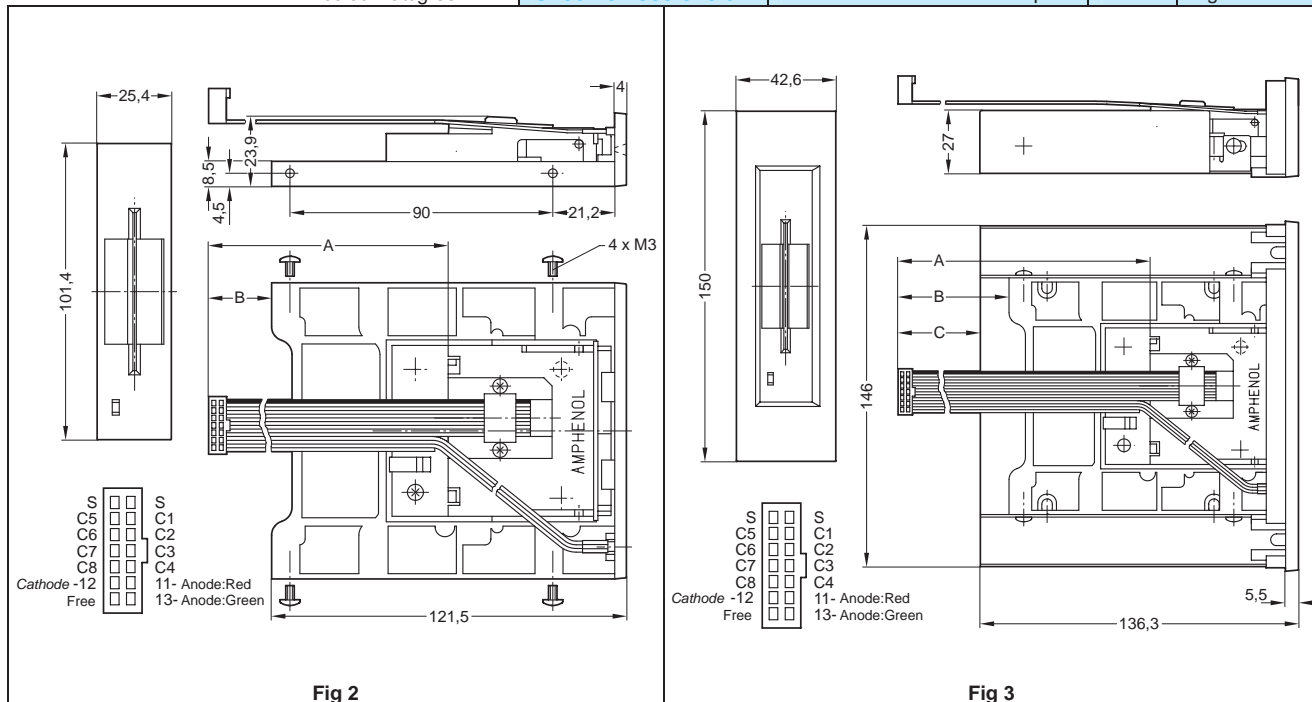

ATE

### C702E Wiping Contact Full Smart Card Connectors

Ideal for limited mating cycle application such as set top boxes.

#### Electrical

Contact resistance - < 30 mΩ  
 Switch contacts - < 50 mΩ  
 Insulation - > 10<sup>9</sup> Ω  
 High Voltage resistance - 500VAC 1 min

#### Environmental

Temperature - -25°C thru 70°C  
 Vibration - IEC 60512-4, Test 6d  
 Shock - IEC 60512-4, Test 6c

#### Switch

Normally closed.  
 Switch activates after data contacts mate.  
 Chatter time - < 5 ms

#### Mechanical

Durability - 10<sup>5</sup> Cycles  
 Mounting is Dip Solder Pin unless otherwise indicated

#### Soldering conditions

Wave Soldering - 260°C, 10s max  
 Infrared Reflow - 230°C, 30s max

#### Features

- DIP solder or SMT
- Self cleaning switch
- Special contact to minimize card scratching
- Indicated connectors according to EMV

Part Number:	Description	Chip	Diagram
C702 10M008 272 4	B/L, EMV, SC	ISO	Fig 1
C702 10M008 255 4	B/L, EMV, SC, 3mm	ISO	Like Fig 1
C702 10M008 271 4	B/L, EMV, SC, DP	ISO	Fig 2
C702 10M008 283 4	B/L, EMV, SC, 3mm, CG	ISO	Fig 3
C702 10M008 286 4	B/L, EMV, SC, CG	ISO	Like Fig 3
C702 10M008 278 4	B/L, SC, DD	ISO	Fig 4
C702 10M008 279 4	B/L, SC, DD, 3mm	ISO	Fig 4
C702 10M008 295 4	B/L, SC, DD	ISO	Fig 4
C702 10M008 290 4	B/L, SC, DD, DT, DP	ISO	
C702 10M008 294 4	B/L, SC, DD, DT, DP	ISO	
C702 10M008 201 4	SM	ISO	Fig 5
C702 10M008 202 4	SM	AFNOR	Fig 5
C702 10M008 203 4	SM	ISO+AFNOR	Fig 5
C702 10M008 206 4	B/L	ISO	Like Fig 5
C702 10M008 207 4	B/L	AFNOR	Like Fig 5
C702 10M008 205 4	B/L	ISO+AFNOR	Like Fig 5
C702 10M008 244 4	B/L, SC, SMT	ISO	Like Fig 6
C702 10M008 230 4	B/L, SC, CG, SMT	ISO	Fig 6
C702 20M008 224 4	B/L, SC, CG, SMT	ISO+AFNOR	Fig 6
C702 20M008 226 4	B/L SC, CG	ISO	Like Fig 6
C702 20M008 235 4	B/L SC, CG	ISO+AFNOR	Like Fig 6

#### Terminology

B/L	- Board Locks	EMV	- Europay Mastercard Visa
3mm	- 3mm stand-offs	DD	- Double Decker Reader
SC	- Self-Cleaning Switch (N/C)	DP	- Dual Plane Contacts
CG	- Card Guide	DT	- Double Thickness Card
SM	- Screw/Rivot Mount	SMT	- Surface Mount

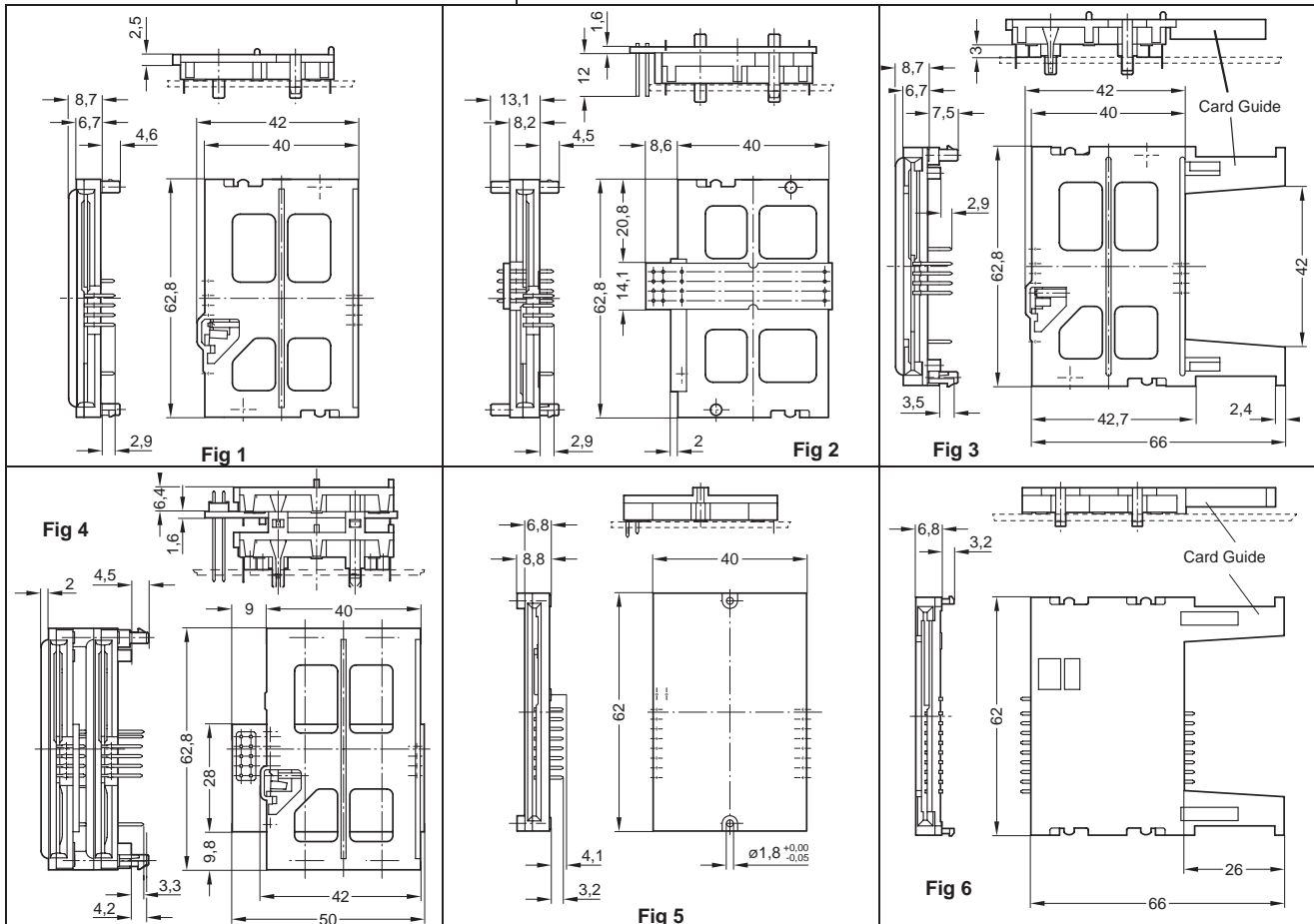

ATE

### C702D Landing Contact Super-flat Full Smart Card Connectors

Second generation Push-Pull connectors with a high degree of miniaturization.

#### Electrical

Contact resistance - < 30 mΩ  
 Switch contacts - < 40 mΩ  
 Insulation - > 10<sup>9</sup> Ω  
 High Voltage resistance - 500VAC 1 min

#### Environmental

Temperature - -25°C thru 65°C  
 Vibration - IEC 60512-4, Test 6d  
 Shock - IEC 60512-4, Test 6c

#### Switch

Normally open. Switch activates after data contacts mate. Chatter time - < 5 ms

#### Durability

- 3 x 10<sup>5</sup> Cycles

Part Number:	Description	Chip	Diagram
C702 10M008 001 4	Standard	ISO	Fig 1
C702 10M008 065 4	Standard, EMV	ISO	Fig 1
C702 10M008 023 4	With Card Guide	ISO	Fig 2
C702 10M008 040 4	Push-Lift, EMV	ISO	Fig 3
C702 10M008 060 4	Board Lock, Dip Solder	ISO	Fig 4
C702 10M008 063 4	Board Lock, Dip Solder, EMV	ISO	Fig 4
C702 10M008 061 4	Board Lock, FFC	ISO	Fig 5
C702 10M008 066 4	Board Lock, FFC, EMV	ISO	Fig 5

#### Features

- According to EMV available
- Snap-in (Board Locks) versions available
- Additional saving option by integrating base into customer's housing
- Chip side up insertion allows for debris egress
- Dip Solder or Flat Flex termination available

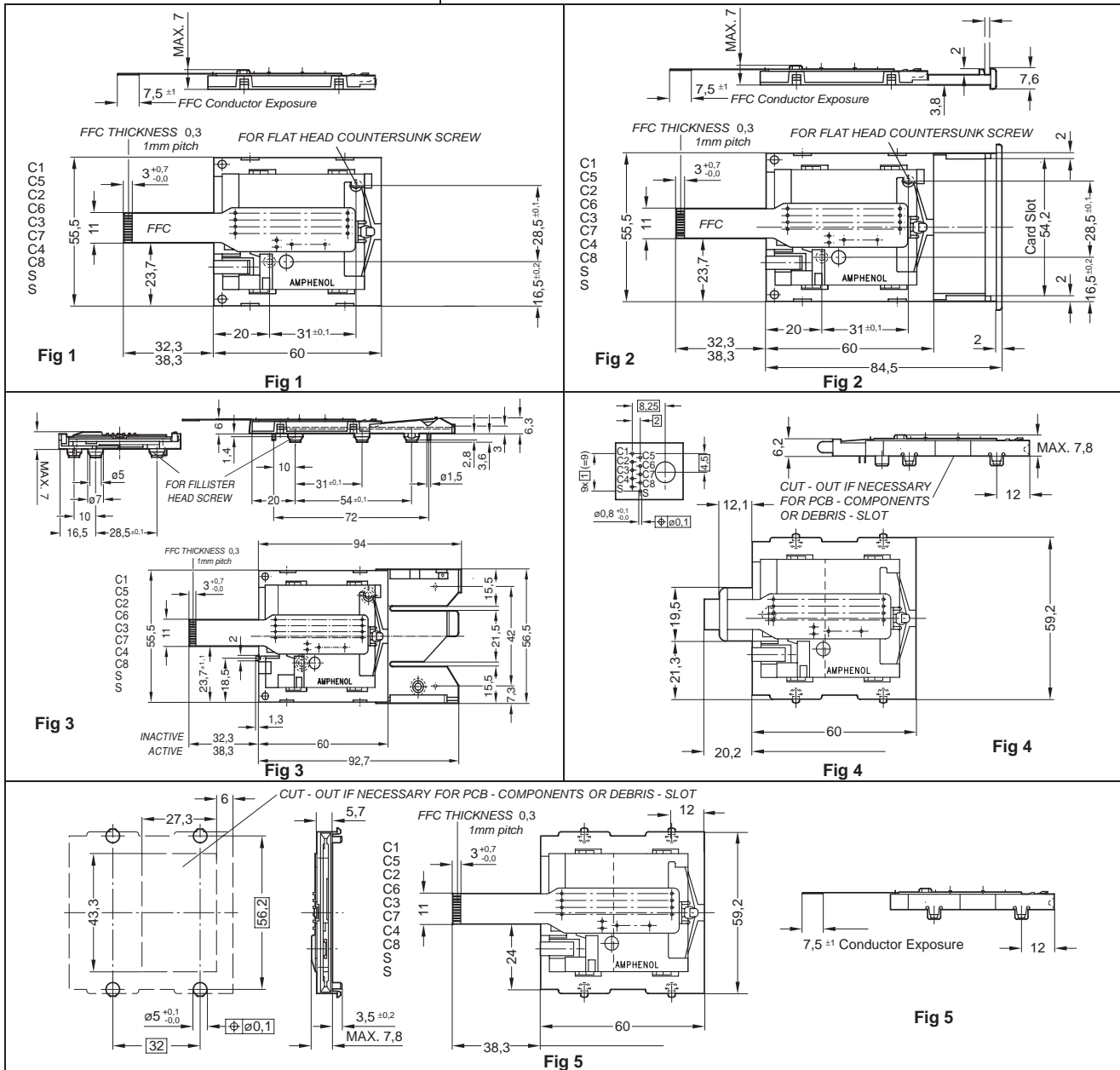

### C702A Accessories Bezels and Mounting Plates for C702A Card Readers

Part Number:	Description	For Reader	Diagram	Remarks
C702 N13 030 E2	Metal Bezel Silver Finish	PUSHMATIC		Mounting plate <b>C702 N15 100 G2</b> necessary to mount bezel
C702 N13 031 E2	Metal Bezel Dull Black Finish			Shipped without Nuts and Bolts
C702 N14 030 E2	Metal Bezel with Coin Spacer Silver Finish			Bezel Mounting Bolt - 2x M3 Nut
C702 N11 141 E2	Plastic Bezel Black Finish	Push-Pull Push Only		Mounting Plate to Reader - 2x Cross recessed countersunk head Bolt M3
				Mounting Plate to Bezel - 2x Threaded roll Bolt AM 3x10 - ST
				Clip-on Technology requires distance plate for various thickness panels N06 702 000 2 - 0.5mm N06 702 000 1 - 1mm

### C702B Accessories Bezels and Mounting Plates for C702B Card Readers

Part Number:	Description	For Reader	Diagram	Remarks
C702 G46 000 G2	Metal Bezel Silver Finish	PUSHMATIC II		Mounting plate <b>C702 G51 012 E2</b> necessary to mount bezel
C702 G46 100 G2	Metal Bezel with Coin Spacer Silver Finish			Shipped without Nuts and Bolts
C702 N25 040 E2	Plastic Adaptor			Bezel Mounting Bolt - 2x M4 Nut
				Mounting Plate to Reader - 2x M4 Bolt & 2x M4 Nut
				Adaptor for common Bezels

ATE

### C702B PUSHMATIC® II Auto-Eject Landing Contact Full Smart Card Reader

The PUSHMATIC II is smaller than the PUSHMATIC and provides additional performance and anti-vandal features.

#### Electrical

Contact resistance	- < 100 mΩ
Switch resistance	- < 200 mΩ
Insulation	- > 10 <sup>9</sup> Ω
High Voltage resistance	- 500VAC 1 min
Rated Voltage/Current Use	- 5V/<10mA ± 10%
<u>Unlocking Solenoid</u>	
Rated Voltage/Current Use	- 5V/5.3A ± 10%
	- 12V/2.2A ± 10%
	- 24V/1.1A ± 10%

Current pulse length	- 10... 25ms
Pulse break	- ≥ 1s
Interface Connector	- 2x8 contact 2mm pitch

#### Environmental

Temperature	- -25°C thru 70°C
Vibration	- IEC 60512-4, Test 6d
Shock	- IEC 60512-4, Test 6c
Chatter time switch	- ≤ 5 ms

#### Mechanical

Durability	- 3 x 10 <sup>5</sup> Cycles
Card Insertion Force	- ≤ 12N

Part Number:	Description	Chip	Diagram
C702 10M008 906 2	5V without card lock	ISO	Fig 1
C702 10M008 904 2	12V without card lock	ISO	Fig 1
C702 10M008 909 2	24V without card lock	ISO	Fig 1
C702 10M008 907 2	5V with card lock	ISO	Fig 2
C702 10M008 905 2	12V with card lock	ISO	Fig 2
C702 10M008 910 2	24V with card lock	ISO	Fig 2

#### Contact Assignment

Pin #	1	2	3	4	5	6	7	8
Contact	M1+	M1-,M2-	M2+	S1	+5V	S1	C8	C4
Remark	+V Solenoid Unlock	-V Solenoid Supply	+V Solenoid Failure	Card Present	Reader Supply	Card Present	Reserve IEC 7816	Reserve IEC 7816
Pin #	9	10	11	12	13	14	15	16
Contact	C7	C3	C6	C2	C5	C1	S2	S3
Remark	I/O Smart Card	Clk Smart Card	Vpp Smart Card	RST Smart Card	GND Smart Card	+5V Smart Card	Card Seated High	EMV High Active

#### Features

- ISO Chip Position
- Card accessible during power failure
- Card presence switch can be used as system wake up
- Card end position switch can be used as lock sensor
- Additional sensor detects abnormal transaction termination
- Self cleaning retracting contacts
- Card presence switch according to EMV
- Housing bottom features large debris slot allowing egress of coins or paper

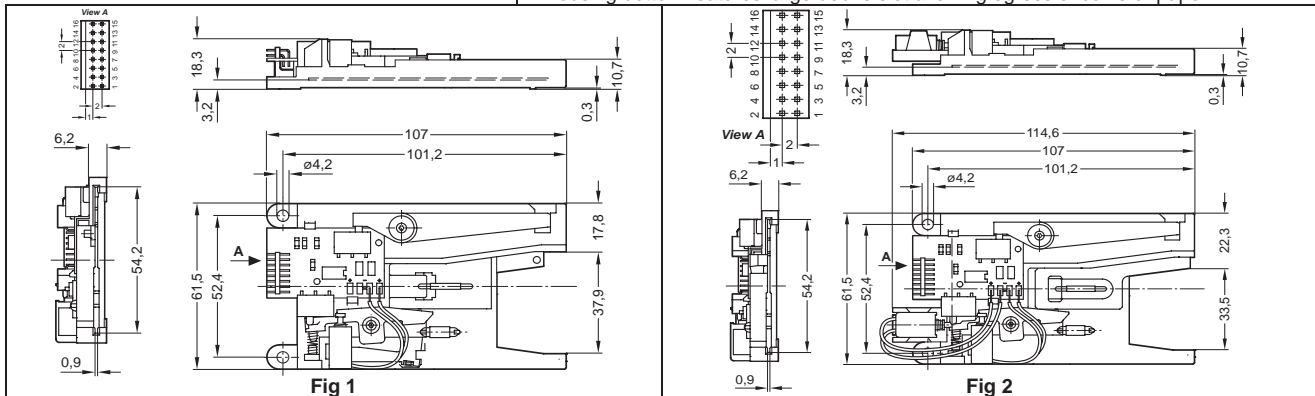

### C702C LP PUSHMATIC® Auto-Eject Landing Contact Full Smart Card Reader

Low Profile Reader designed for restricted spaces. With removable housing bottom to act a debris slot.

#### Electrical

Contact resistance	- < 100 mΩ
Switch resistance	- < 200 mΩ
Insulation	- > 10 <sup>9</sup> Ω
High Voltage resistance	- 500VAC 1 min
Rated Voltage/Current Use	- 5V/<10mA ± 10%
<u>Unlocking Solenoid</u>	
Rated Voltage/Current Use	- 5V/2.6A ± 10%
	- 12V/1.5A ± 10%
	- 24V/1A ± 10%

Current pulse length	- 10... 30ms
Pulse break	- ≥ 1s
Interface Connector	- 10 Contact 1mm FFC

#### Environmental

Temperature	- -25°C thru 70°C
Vibration	- IEC 60512-4, Test 6d
Shock	- IEC 60512-4, Test 6c
Chatter time switch	- ≤ 5 ms

#### Mechanical

Durability	- 3 x 10 <sup>5</sup> Cycles
Card Insertion Force	- ≤ 10N

Part Number:	Description	Chip	Diagram
C702 10M008 901 4	5V with card lock	ISO	Fig 3
C702 10M008 902 4	12V with card lock	ISO	Fig 3
C702 10M008 903 4	24V with card lock	ISO	Fig 3

#### Features

- Landing self cleaning contacts
- Micro Switch as locking sensor
- Card present switch acc. To EMV
- Manual card unlock on power failure

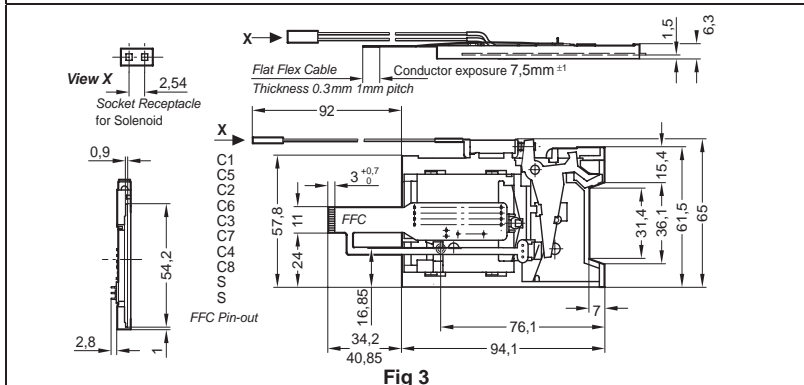

ATE