

4



3

2



1

THIS DRAWING IS UNPUBLISHED. RELEASED FOR PUBLICATION  
 © COPYRIGHT BY TYCO ELECTRONICS CORPORATION. ALL RIGHTS RESERVED.

LOC		DISTR		REVISIONS		
P	LR	DESCRIPTION	DATE	MIN	APPR	
R		REV PER 0H14-0191-05	05-05	AA	DE	

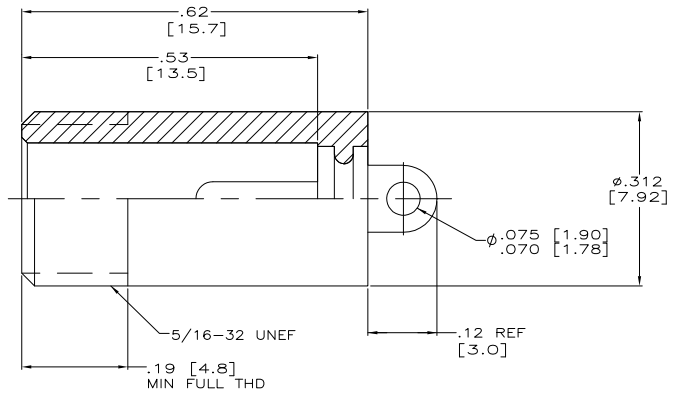
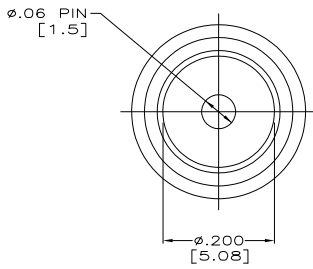
- RECEPTACLE TO MATE WITH AMP LGH-1/2 LEAD ASSY.
  - MARKED PER MIL-STD-130.
-  SPECIAL TESTING REQUIRED.  
 CUSTOMER PART NO. 44121-001 MARKED PER MIL-STD-130.



-	.000150 MIN TIN	5-830178-1
	.000150 MIN TIN-LEAD	830178-8
	.000150 MIN TIN-LEAD	830178-7
-	.000050 MIN GOLD	830178-3
-	.000030 MIN GOLD	830178-2
-	.000150 MIN TIN-LEAD	830178-1
REMARKS	TERMINAL PLATING	PART NO.

THIS DRAWING IS A CONTROLLED DOCUMENT.		DWG: C.C. THOMAS 23-MAR-94 OK: D. EASY 24-MAR-94 APPR: D. EASY 24-MAR-94 NAME:	 Tyco Electronics Corporation Harrisburg, Pa 17105-3608
DIMENSIONS: INCHES	DIMENSIONS UNLESS OTHERWISE SPECIFIED: 0 PLG # - 1 PLG # - 2 PLG # .000(.03) 3 PLG # .000(.15) 4 PLG # - ANGLES # - FINISH -	APPLICATION SPEC: - HEIGHT: - CUSTOMER DRAWING	SIZE: A2 QAGE CODE: 00779 DRAWING NO: C-830178 RESTRICTED TO: - SCALE: 4:1 SHEET 1 OF 1 REV R