

# Series HD



## Series HD

### **HD-Inserts 7 - 128 Pole Crimp contacts**

- Stamped or turned crimp contacts
- Pole number:  
7, 8, 15, 16, 24, 25, 40, 50, 64, 80, 128

# Series HD

## Technical data

Standards	<b>Series HD</b> DIN VDE 0627 DIN VDE 0110
Approvals	
<b>Inserts</b>	
Contact numbers	7, 8, 15, 16, 24, 25, 40, 50, 64, 80, 128 (+PE)
Rated current	10 A max.
Rated voltage (VDE 110/1.89 )	250V
Rated impulse voltage	4 kV
Pollution degree	3
Contact resistance	10 <sup>15</sup> Ohmcm
Material	Thermoplastic glass-fibre reinforced ( UL listed )
Temperature range	-40° .... + 125° C
Flammability class acc. UL 94	V-0
Mechanical durability	
- insertion frequency Sn	≤ 50
- insertion frequency Ag	≤ 100
- insertion frequency Au	≤ 500
Rated voltage	
- acc. UL / CSA	250 V
Connection method	Crimp

## Technical data

<b>Series HD</b>	
<b>Contacts</b>	
Material	Copper alloy
Plating	
- tin plated	2 to 5 µm
- silver plated	3 µm Ag
- gold plated	0.8 µm Au over 2 µm Ni
Through resistance	< 3mOhm
Clamping range	
- mm <sup>2</sup>	0.14 - 2.5
- AWG	26 ... 14
Insulation stripping length	
- stamped crimp contacts	3.5 mm
- turned crimp contacts	8.0 mm
<b>Housings</b>	
Material	
Group size 1	Die cast zinc / thermoplastic
Group size 2 -12	Aluminium die casting AL-Si 12
Flammability class acc. UL 94 ( Group size 1 in thermoplastic )	V-0
Plating	Powder coating, grey
Locking	
- standard	Steel, zinc plated
Gasket	NBR
Temperature range	-40° .... + 125° C
Protection in accordance with DIN	
- when locked	IP 65

## Derating curves

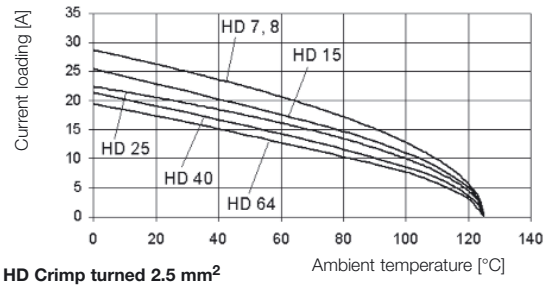
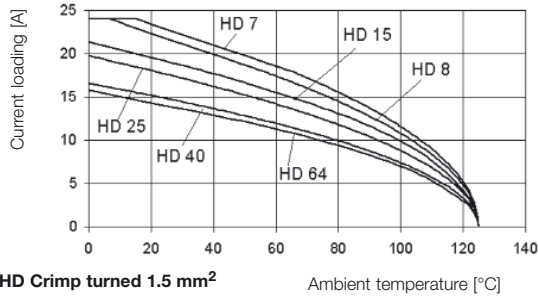

Further derating curves on request

## Turned crimp contacts for HD, HDD and ConCept housing inserts

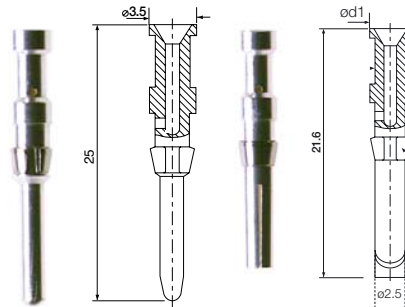

Crimp male						
Cross-sec. mm <sup>2</sup>	AWG	Plating	Type	Cat. No.	Qty.	
0.14 - 0.37	26...22	Au	HDC-C-HD-SM0.14-0.37Au	<b>1651620000</b>	100	
	26...22	Ag	HDC-C-HD-SM0.14-0.37Ag	<b>1651520000</b>	100	
0.5	20	Au	HDC-C-HD-SM0.5Au	<b>1651630000</b>	100	
	20	Ag	HDC-C-HD-SM0.5Ag	<b>1651530000</b>	100	
0.75 - 1.00	18	Au	HDC-C-HD-SM0.75-1.00Au	<b>1651640000</b>	100	
	18	Ag	HDC-C-HD-SM0.75-1.00Ag	<b>1601750000</b>	100	
1.5	16	Au	HDC-C-HD-SM1.5Au	<b>1651650000</b>	100	
	16	Ag	HDC-C-HD-SM1.5Ag	<b>1651550000</b>	100	
2.5	14	Au	HDC-C-HD-SM2.5Au	<b>1651660000</b>	100	
	14	Ag	HDC-C-HD-SM2.5Ag	<b>1651560000</b>	100	

Crimp female						
Cross-sec. mm <sup>2</sup>	AWG	Plating	Type	Cat. No.	Qty.	
0.14 - 0.37	26...22	Au	HDC-C-HD-BM0.14-0.37Au	<b>1651670000</b>	100	
	26...22	Ag	HDC-C-HD-BM0.14-0.37Ag	<b>1651570000</b>	100	
0.5	20	Au	HDC-C-HD-BM0.5Au	<b>1651680000</b>	100	
	20	Ag	HDC-C-HD-BM0.5Ag	<b>1651580000</b>	100	
0.75 - 1.00	18	Au	HDC-C-HD-BM0.75-1.00Au	<b>1651690000</b>	100	
	18	Ag	HDC-C-HD-BM0.75-1.00Ag	<b>1601760000</b>	100	
1.5	16	Au	HDC-C-HD-BM1.5Au	<b>1651700000</b>	100	
	16	Ag	HDC-C-HD-BM1.5Ag	<b>1651600000</b>	100	
2.5	14	Au	HDC-C-HD-BM2.5Au	<b>1651710000</b>	100	
	14	Ag	HDC-C-HD-BM2.5Ag	<b>1651610000</b>	100	

# Series HD

## Stamped crimp contacts for HD housing inserts

### Single contacts



### Bandolier contacts



### CB/CS-contact

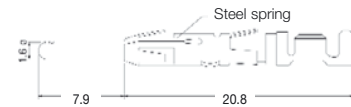
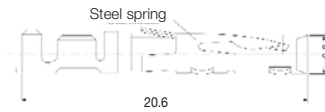

### Contact system CB/CS

- High contact reliability with four defined contact points
- Locating hooks in the steel spring offer a reliable fit in the housing
- As many as 500 mating cycles (gold version)
- As many as 100 mating cycles (tin version)

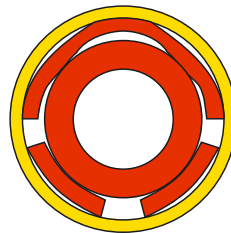

Series HD

## Stamped crimp contacts CB/CS, 4 contact points

### Crimp male

Cross-sec. mm <sup>2</sup>	AWG	Insul.-ø mm	Plating
0.14-0.2	26...24	0.8...1.4	Au Sn Pb
0.32...0.5	22...20	1.1...1.8	Au Sn Pb
0.32...0.5	22...20	2.0...2.5	Au Sn Pb
0.75...1.5	18...16	2.0...2.5	Au Sn Pb
0.75...1.5	18...16	2.0...3.5	Sn Pb

### Single contacts

Type	Cat. No.	Qty.
CS 1.6 HD E 26...24 AU   1.4	1542200000	250
CS 1.6 HD E 26...24 SN   1.4	1542600000	250
CS 1.6 HD E 22...20 AU   1.8	1542800000	250
CS 1.6 HD E 22...20 SN   1.8	1543200000	250
CS 1.6 HD E 22...20 AU   2.5	1543400000	250
CS 1.6 HD E 22...20 SN   2.5	1543800000	250
CS 1.6 HD E 18...16 AU   2.5	1544000000	250
CS 1.6 HD E 18...16 SN   2.5	1544400000	250
CS 1.6 HD E 18...16 SN   3.5	1582520000	250

### Bandolier contacts

Type	Cat. No.	Qty.
CS 1.6 HD R 26...24 AU   1.4	1542100000	5000
CS 1.6 HD R 26...24 SN   1.4	1542500000	5000
CS 1.6 HD R 22...20 AU   1.8	1542700000	5000
CS 1.6 HD R 22...20 SN   1.8	1543100000	5000
CS 1.6 HD R 22...20 AU   2.5	1543300000	5000
CS 1.6 HD R 22...20 SN   2.5	1543700000	5000
CS 1.6 HD R 18...16 AU   2.5	1543900000	5000
CS 1.6 HD R 18...16 SN   2.5	1544300000	5000
CS 1.6 HD R 18...16   3.5	1582530000	4000

### Crimp female

Cross-sec. mm <sup>2</sup>	AWG	Insul.-ø mm	Plating
0.14...0.2	26...14	0.8...1.4	Au Sn Pb
0.32...0.5	22...20	1.1...1.8	Au Sn Pb
0.32...0.5	22...20	2.0...2.5	Au Sn Pb
0.75...1.5	18...16	2.0...2.5	Au Sn Pb
0.75...1.5	18...16	2.0...3.5	Au Sn Pb

Type	Cat. No.	Qty.
CB 1.6 26...24 AU, 75   1.4	1420900000	250
CB 1.6 26...24 SN   1.4	1421900000	250
CB 1.6 22...20 AU, 75   1.8	1422900000	250
CB 1.6 22...20 SN   1.8	1423900000	250
CB 1.6 22...20 AU, 75   2.5	1424900000	250
CB 1.6 22...20 SN   2.5	1425900000	250
CB 1.6 18...16 AU, 75   2.5	1426900000	250
CB 1.6 18...16 SN   2.5	1427900000	250
CB 1.6 16...18 AU 0.75   3.5	1582410000	250
CB 1.6 16...18 SN   3.5	1582430000	250

Type	Cat. No.	Qty.
CB 1.6 26...24 AU, 75   1.4	1420800000	5000
CB 1.6 26...24 SN   1.4	1421800000	5000
CB 1.6 22...20 AU, 75   1.8	1422800000	5000
CB 1.6 22...20 SN   1.8	1423800000	5000
CB 1.6 22...20 AU, 75   2.5	1424800000	5000
CB 1.6 22...20 SN   2.5	1425800000	5000
CB 1.6 18...16 AU, 75   2.5	1426800000	5000
CB 1.6 18...16 SN   2.5	1427800000	5000
CB 1.6 18...16 AU 0.75   3.5	1582420000	4000
CB 1.6 18...16 SN   3.5	1582440000	4000

# Inserts Group Size 1

## Crimp connection series HD-7

7-pole + PE

250 V-/max. 10 A

## Crimp connection series HD-8

8-pole + PE

250 V-/max. 10 A



Male



Female



Male



Female

### Dimensions

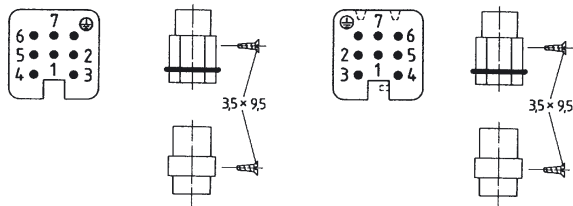

### Dimensions

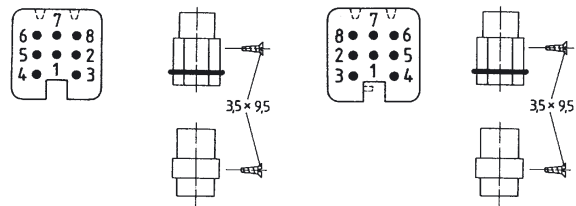

Version	Type	Cat. No.	Qty.
<b>For stamped contacts</b>			
Male	HDC-HD-7SCG	1650550000	10
Female	HDC-HD-7BCG	1650560000	10
<b>For turned contacts</b>			
Male	HDC-HD-7SCM	1650570000	10
Female	HDC-HD-7BCM	1650580000	10

Version	Type	Cat. No.	Qty.
<b>For turned contacts</b>			
Male	HDC-HD-8SCM	1650590000	10
Female	HDC-HD-8BCM	1650600000	10

For crimp contacts see page 62 and 63

250 V only when using plastic housing  
42 V only when using metal housing

For crimp contacts see page 62 and 63

250 V only when using plastic housing  
42 V only when using metal housing

For accessories see section "Accessories"

# Housings Group Size 1

## Plug hood HA-3/HAD-7

End locking / lower side



TOVL

## Plug hood HA-3/HAD-7

End locking / lower side



TWVL

## Base housing HA-3/HAD-7

End locking



SVL

### Dimensions

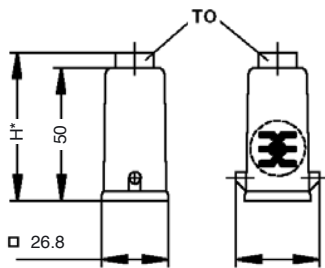

H\* M = 50  
PG, Metal = 57  
PG, Plastic = 62

### Dimensions

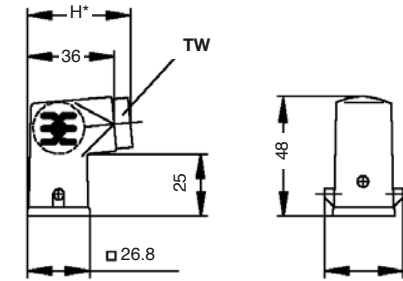

H\* M = 36  
PG, Metal = 43  
PG, Plastic = 48

### Dimensions

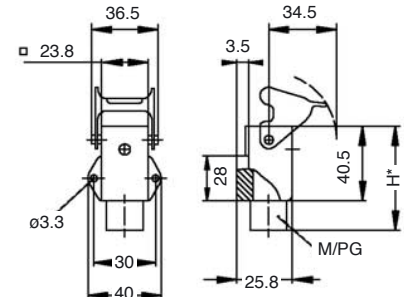

H\* M = 40.5  
PG, Metal = 57  
PG, Plastic = 62

Version	Type	Cat. No.	Qty.
<b>Plastic housing, metric thread</b>			
1 x M 20 thread	HDC HAD7 TOVL 1xM20G	1788520000	10
<b>Plastic housing, PG thread</b>			
1 x Pg 11 complete	HDC-HAD-7-TOVL1/11P	1652370000	10
1 x Pg 11 sleeve	HDC-HAD-7-TOVL1/11	1652380000	10
<b>Metal housing, metric thread</b>			
1 x M 20 thread	HDC HA3 TOVL 1xM20G	1788820000	10
<b>Metal housing, PG thread</b>			
1 x Pg 11 complete	HDC-HA-3-TOVL1/11P	1498500000	10
1 x Pg 11 sleeve	HDC-HA-3-TOVL1/11	1652470000	10

TOVL = Plug hood; Top cable entry, end locking  
HAD-7 = Plastic housing  
HA-3 = Metal housing

Version	Type	Cat. No.	Qty.
<b>Plastic housing, metric thread</b>			
1 x M 20 thread	HDC HAD7 TWVL 1xM20G	1788510000	10
<b>Plastic housing, PG thread</b>			
1 x Pg 11 complete	HDC-HAD-7-TWVL1/11P	1652390000	10
1 x Pg 11 sleeve	HDC-HAD-7-TWVL1/11	1652400000	10
<b>Metal housing, metric thread</b>			
1 x M 20 thread	HDC HA3 TWVL 1xM20G	1788810000	10
<b>Metal housing, PG thread</b>			
1 x Pg 11 complete	HDC-HA-3-TWVL1/11P	1498600000	10
1 x Pg 11 sleeve	HDC-HA-3-TWVL1/11	1652480000	10

TWVL = Plug hood angled, end locking  
HAD-7 = Plastic housing  
HA-3 = Metal housing

Version	Type	Cat. No.	Qty.
<b>Plastic housing, metric thread</b>			
1 x M 20 thread	HDC HAD7 SVL 1xM20G	1788530000	10
<b>Plastic housing, PG thread</b>			
1 x Pg 11 complete	HDC-HAD-7-SVL1/11P	1652430000	10
1 x Pg 11 sleeve	HDC-HAD-7-SVL1/11	1652440000	10
<b>Metal housing, metric thread</b>			
1 x M 20 sleeve	HDC HA3 SVL 1xM20	1788830000	10
<b>Metal housing, PG thread</b>			
1 x Pg 11 complete	HDC-HA-3-SVL1/11P	1497800000	10
1 x Pg 11 sleeve	HDC-HA-3-SVL1/11	1652490000	10

SVL = Base housing, end locking  
HAD-7 = Plastic housing  
HA-3 = Metal housing

Series HD

For accessories see section "Accessories"

# Housings Group Size 1

## Coupling hood HA-3/HAD-7

End locking



**KVL**

Dimensions

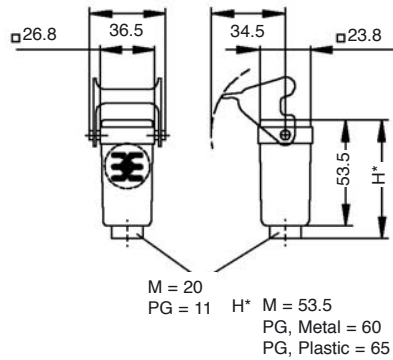

Version	Type	Cat. No.	Qty.
<b>Plastic housings, metric thread</b>			
1 x M 20 thread	HDC HAD7 KVL 1xM20G	1788540000	10
<b>Plastic housings, PG thread</b>			
1 x Pg 11 complete	HDC-HAD-7-KVL1/11P	1652450000	10
1 x Pg 11 sleeve	HDC-HAD-7-KVL1/11	1652460000	10
<b>Metal housings, metric thread</b>			
1 x M 20 thread	HDC HA3 KVL 1xM20G	1788840000	10
<b>Metal housings, PG thread</b>			
1 x Pg 11 complete	HDC-HA-3-KVL1/11P	1497900000	10
1 x Pg 11 sleeve	HDC-HA-3-KVL1/11	1652500000	10

**KVL** = Coupling hood, end locking  
**HAD-7** = Plastic housing  
**HA-3** = Metal housing

## Bulkhead housing HA-3/HAD-7

End locking



**AVL**

Dimensions

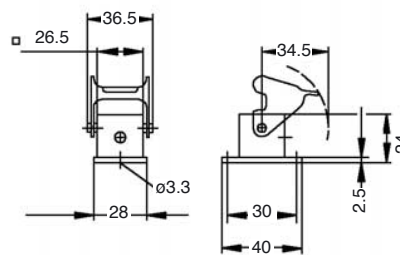

Version	Type	Cat. No.	Qty.
<b>Plastic housings</b>			
	HDC-HAD-7-AVL	1652410000	10
<b>Metal housings</b>			
	HDC-HA-3-AVL	1497600000	10

**AVL** = Bulkhead housing, end locking  
**HAD-7** = Plastic housing  
**HA-3** = Metal housing

## Bulkhead housing angled HA-3/HAD-7

End locking



**AWVL**

Dimensions

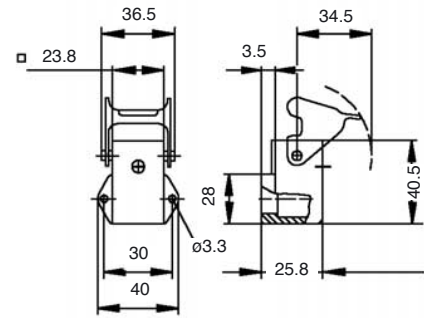

Version	Type	Cat. No.	Qty.
<b>Plastic housing</b>			
	HDC-HAD-7-AWVL	1652420000	10
<b>Metal housing</b>			
	HDC-HA-3-AWVL	1497700000	10

**AWVL** = Bulkhead housing angled, end locking  
**HAD-7** = Plastic housing  
**HA-3** = Metal housing

## Cover for housing with end locking

Plastic / Cover with cord

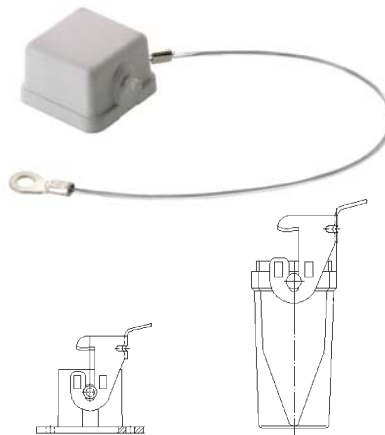

Version / Type	Cat. No.	Qty.
<b>Plastic cover</b>		
HDC-HA-3-KDBF-S	1665760000	10
HDC-HA-3-KDBF-B	1665770000	10

S = Cover without sealing when using male inserts  
 B = Cover with sealing when using female inserts

Metal / Cover with cord

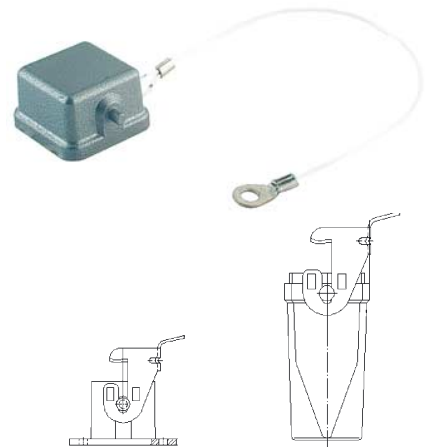

Version / Type	Cat. No.	Qty.
<b>Metal cover</b>		
HDC-HA-3-MDBF-S	1665740000	10
HDC-HA-3-MDBF-B	1665750000	10

S = Cover without sealing when using male inserts  
 B = Cover with sealing when using female inserts

For accessories see section "Accessories"

# Inserts Group Size 2

## Crimp connection series HD-15

15-pole

250 V-/max 10 A



Male



Female

### Dimensions

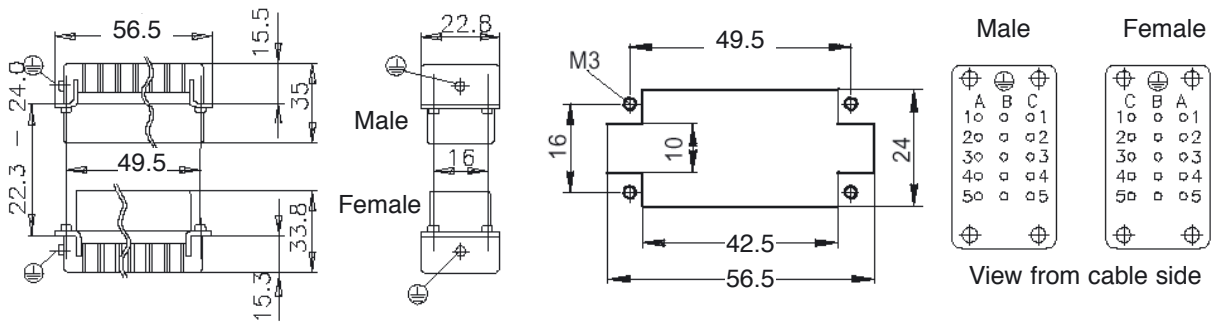

Series HD

Version	Type	Cat. No.	Qty.
<b>For stamped contacts</b>			
Male	HDC-HD-15SCG	1650630000	5
<b>For turned contacts</b>			
Male	HDC-HD-15SCM	1650650000	5

Version	Type	Cat. No.	Qty.
<b>For stamped contacts</b>			
Female	HDC-HD-15BCG	1650640000	5
<b>For turned contacts</b>			
Female	HDC-HD-15BCM	1650660000	5

For crimp contacts see page 62 and 63

For crimp contacts see page 62 and 63

For accessories see section "Accessories"



# Housings Group Size 2

## Plug hood HA-10

End locking / lower side



TOVL



TSVL

## Base housing HA-10

End locking / with/without cover



SVL



SDVL

## Coupling hood HA-10 / HAD-15

End locking



KVL

### Dimensions

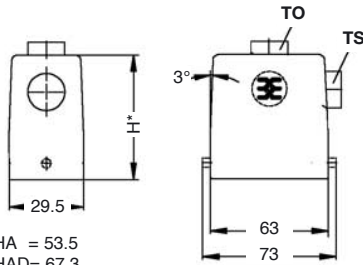

\*HA = 53.5  
HAD= 67.3

### Dimensions

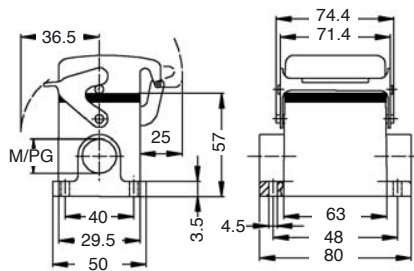

### Dimensions

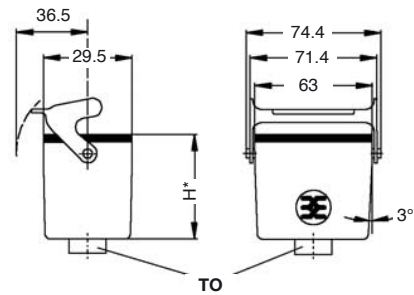

\*HA = 48  
HAD= 62

Version	Type	Cat. No.	Qty.
<b>Standard housings, metric thread</b>			
1 x M 20 thread	HDC HA10 TOVL 1xM20G	1788620000	5
1 x M 25 thread	HDC HA10 TOVL 1xM25G	1788610000	5
1 x M 20 sleeve	HDC HA10 TSVL 1xM20	1788600000	5
1 x M 25 sleeve	HDC HA10 TSVL 1xM25	1788590000	5
1 x M 20 thread	HDC HAD15 TOVL 1xM20G	1788880000	5
1 x M 25 thread	HDC HAD15 TOVL 1xM25G	1788870000	5
1 x M 20 thread	HDC HAD15 TSVL 1xM20G	1788860000	5
1 x M 25 thread	HDC HAD15 TSVL 1xM25G	1788850000	5
<b>Standard housings, PG thread</b>			
1 x Pg16 complete	HDC-HA-10-TOVL1/16P	1663920000	5
1 x Pg16 sleeve	HDC-HA-10-TOVL1/16	1663930000	5
1 x Pg16 complete	HDC-HA-10-TSVL1/16P	1663800000	5
1 x Pg16 sleeve	HDC-HA-10-TSVL1/16	1663810000	5
1 x Pg16 complete	HDC-HAD-15-TOVL1/16P	1663960000	5
1 x Pg21 complete	HDC-HAD-15-TOVL1/21P	1663980000	5
1 x Pg21 sleeve	HDC-HAD-15-TOVL1/21	1663990000	5
1 x Pg16 complete	HDC-HAD-15-TSVL1/16P	1663840000	5
1 x Pg16 sleeve	HDC-HAD-15-TSVL1/16	1663850000	5
1 x Pg21 complete	HDC-HAD-15-TSVL1/21P	1663860000	5
1 x Pg21 sleeve	HDC-HAD-15-TSVL1/21	1663870000	5

Version	Type	Cat. No.	Qty.
<b>Standard housings, metric thread</b>			
2 x M 20 thread	HDC HA10 SVL 2xM20G	1788640000	5
2 x M 25 thread	HDC HA10 SVL 2xM25G	1788630000	5
<b>Standard housings with cover, metric thread</b>			
2 x M 20 thread	HDC HA10 SDVL 2xM20G	1788660000	5
2 x M 25 thread	HDC HA10 SDVL 2xM25G	1788650000	5
<b>Standard housings, PG thread</b>			
1 x Pg16 complete	HDC-HA-10-SVL1/16P	1664160000	5
1 x Pg16 sleeve	HDC-HA-10-SVL1/16	1664170000	5
1 x Pg21 complete	HDC-HA-10-SVL1/21P	1664200000	5
1 x Pg21 sleeve	HDC-HA-10-SVL1/21	1664210000	5
2 x Pg16 complete	HDC-HA-10-SVL2/16P	1664180000	5
2 x Pg16 sleeve	HDC-HA-10-SVL2/16	1664190000	5
<b>Standard housings with cover, PG thread</b>			
1 x Pg16 complete	HDC-HA-10-SDVL1/16P	1664400000	5
1 x Pg16 sleeve	HDC-HA-10-SDVL1/16	1664410000	5
2 x Pg16 complete	HDC-HA-10-SDVL2/16P	1664420000	5

Version	Type	Cat. No.	Qty.
<b>Standard housings, metric thread</b>			
1 x M 25 thread	HDC HA10 KVL 1xM25G	1788670000	5
1 x M 25 thread	HDC HAD15 KVL 1xM25G	1788890000	2
<b>Standard housings, PG thread</b>			
1 x Pg16 complete	HDC-HA-10-KVL1/16P	1664560000	5
1 x Pg21 complete	HDC-HAD-15-KVL1/21P	1664620000	2
1 x Pg21 sleeve	HDC-HAD-15-KVL1/21	1664630000	2

TOVL = Plug hood; Top cable entry, end locking

TSVL = Plug hood; Side cable entry, end locking

SVL = Base housing, end locking

SDVL = Base housing with cover, end locking

KVL = Coupling hood, end locking

For accessories see section "Accessories"

# Housings Group Size 2

## Bulkhead housing HA-10

End locking / with/without cover



AVL



ADVL

### Dimensions

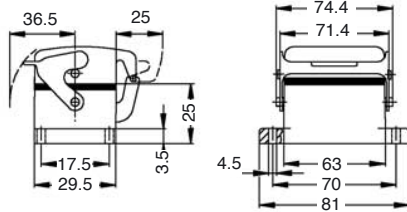

## Cover for plug hood

Cover with cord



## Cover for housings with end locking

Cover with cord



Series HD

Version	Type	Cat. No.	Qty.
<b>Standard housings</b>			
	HDC-HA-10-AVL	1664040000	5

<b>Standard housings with cover</b>			
	HDC-HA-10-ADVL	1664060000	5

Version / Type	Cat. No.	Qty.
<b>Plastic cover</b>		
HDC-HA-10-KDF	1665890000	5

Version / Type	Cat. No.	Qty.
<b>Plastic cover</b>		
HDC-HA-10-KDBF	1665880000	5

ADVL = Bulkhead housing with cover, end locking

AVL = Bulkhead housing, end locking

For accessories see section "Accessories"

# Inserts Group Size 3

## Crimp connection series HD-16

16-pole

250 V-/max 10 A



Male



Female

### Dimensions

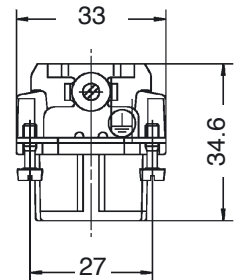
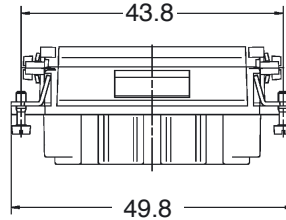
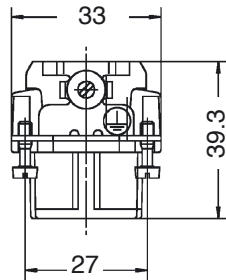
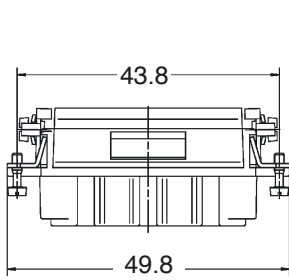

Version	Type	Cat. No.	Qty.
<b>For stamped contacts</b>			
Male	HDC-HD-16SCG	1572520000	5
<b>For turned contacts</b>			
Male	HDC-HD-16SCM	1650710000	5

Version	Type	Cat. No.	Qty.
<b>For stamped contacts</b>			
Female	HDC-HD-16BCG	1572530000	5
<b>For turned contacts</b>			
Female	HDC-HD-16BCM	1650720000	5

For crimp contacts see page 62 and 63

For crimp contacts see page 62 and 63

For accessories see section "Accessories"

# Housings Group Size 3

## Plug hood HB-6

End locking / lower side



TOVL

## Plug hood HBD-16

End locking / lower side / high version



TOVL

## Base housing HB-6

End locking, with/without cover



SVL



SDVL

### Dimensions

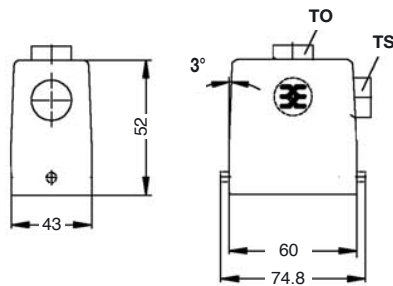

### Dimensions

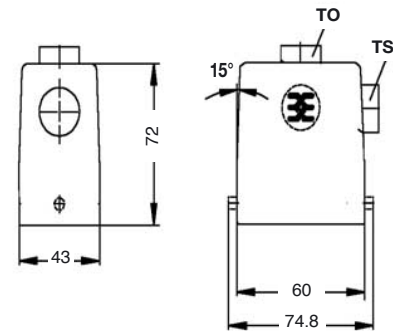

### Dimensions

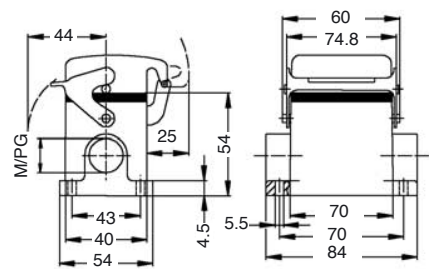

Version	Type	Cat. No.	Qty.
<b>Standard housings, metric thread</b>			
1 x M 20 thread	HDC HB6 TOVL 1xM20G	1788120000	5
1 x M 25 thread	HDC HB6 TOVL 1xM25G	1788110000	5
1 x M 20 thread	HDC HB6 TSVL 1xM20G	1805930000	5
1 x M 20 sleeve	HDC HB6 TSVL 1xM20	1788100000	5
1 x M 25 sleeve	HDC HB6 TSVL 1xM25	1788090000	5
<b>Standard housings, PG thread</b>			
1 x Pg13 complete	HDC-HB-6-TOVL1/13P	1201800000	5
1 x Pg13 sleeve	HDC-HB-6-TOVL1/13	1670500000	5
1 x Pg16 complete	HDC-HB-6-TOVL1/16P	1652630000	5
1 x Pg16 sleeve	HDC-HB-6-TOVL1/16	1652640000	5
1 x Pg13 complete	HDC-HB-6-TSVL1/13P	1201900000	5
1 x Pg13 sleeve	HDC-HB-6-TSVL1/13	1670530000	5
1 x Pg16 complete	HDC-HB-6-TSVL1/16P	1652510000	5
1 x Pg16 sleeve	HDC-HB-6-TSVL1/16	1652520000	5

Version	Type	Cat. No.	Qty.
<b>Standard housings, metric thread</b>			
1 x M 25 thread	HDC HBD16 TOVL 1xM25G	1787500000	5
1 x M 32 thread	HDC HBD16 TOVL 1xM32G	1787490000	5
1 x M 25 thread	HDC HBD16 TSVL 1xM25G	1787480000	5
1 x M 32 thread	HDC HBD16 TSVL 1xM32G	1787470000	5
<b>Standard housings, PG thread</b>			
1 x Pg21 complete	HDC-HBD-16-TOVL1/21P	1652670000	5
1 x Pg21 sleeve	HDC-HBD-16-TOVL1/21	1652680000	5
1 x Pg29 complete	HDC-HBD-16-TOVL1/29P	1652690000	5
1 x Pg29 sleeve	HDC-HBD-16-TOVL1/29	1652700000	5
1 x Pg21 complete	HDC-HBD-16-TSVL1/21P	1652550000	5
1 x Pg21 sleeve	HDC-HBD-16-TSVL1/21	1652560000	5
1 x Pg29 complete	HDC-HBD-16-TSVL1/29P	1652570000	5
1 x Pg29 sleeve	HDC-HBD-16-TSVL1/29	1652580000	5

Version	Type	Cat. No.	Qty.
<b>Standard housings, metric thread</b>			
2 x M 20 thread	HDC HB6 SVL 2xM20G	1788140000	5
2 x M 25 thread	HDC HB6 SVL 2xM25G	1788130000	5
<b>Standard housings with cover, metric thread</b>			
2 x M 20 thread	HDC HB6 SDVL 2xM20G	1788170000	2
2 x M 25 thread	HDC HB6 SDVL 2xM25G	1788160000	2
<b>Standard housings, PG thread</b>			
1 x Pg16 complete	HDC-HB-6-SVL1/16P	1202200000	5
1 x Pg16 sleeve	HDC-HB-6-SVL1/16	1652750000	5
2 x Pg16 complete	HDC-HB-6-SVL2/16P	1202300000	5
2 x Pg16 sleeve	HDC-HB-6-SVL2/16	1652760000	5
<b>Standard housings with cover, PG thread</b>			
1 x Pg16 complete	HDC-HB-6-SDVL1/16P	1202600000	2
1 x Pg16 sleeve	HDC-HB-6-SDVL1/16	1652980000	2
2 x Pg16 complete	HDC-HB-6-SDVL2/16P	1202700000	2
2 x Pg16 sleeve	HDC-HB-6-SDVL2/16	1652990000	2

TOVL = Plug hood; Top cable entry, end locking  
 TSVL = Plug hood; Side cable entry, end locking

TOVL = Plug hood; Top cable entry, end locking  
 TSVL = Plug hood; Side cable entry, end locking

SVL = Base housing, end locking  
 SDVL = Base housing with cover, end locking

For accessories see section "Accessories"

Series HD

# Housings Group Size 3

## Base housing HBD-16

End locking, with/without cover, high version



SVL



SDVL

## Coupling hood HB-6 / HBD-16

End locking



KVL



KVL

## Bulkhead housing HB-6

End locking, with/without cover



ADVL

### Dimensions

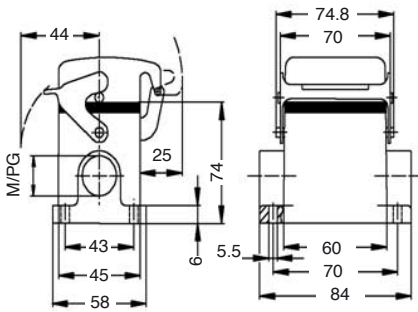

### Dimensions

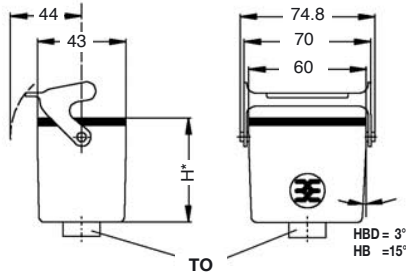

\*HB = 54.8  
HBD = 74.8

### Dimensions

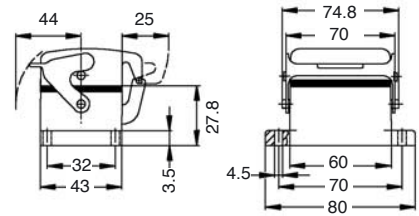

Version	Type	Cat. No.	Qty.
<b>Standard housings with cover, metric thread</b>			
1 x M 25 thread	HDC HBD16 SVL 2xM25G	1787520000	5
1 x M 32 thread	HDC HBD16 SVL 2xM32G	1787510000	5
1 x M 25 thread	HDC HBD16 SDVL 2xM25G	1787540000	2
1 x M 32 thread	HDC HBD16 SDVL 2xM32G	1787530000	2
<b>Standard housings with cover, PG thread</b>			
1 x Pg21 complete	HDC-HBD-16-SVL1/21P	1652810000	5
1 x Pg21 sleeve	HDC-HBD-16-SVL1/21	1652820000	5
1 x Pg29 complete	HDC-HBD-16-SVL1/29P	1652850000	5
2 x Pg21 sleeve	HDC-HBD-16-SVL2/21	1652840000	5
1 x Pg21 complete	HDC-HBD-16-SDVL1/21P	1653040000	2

Version	Type	Cat. No.	Qty.
<b>Standard housings, PG thread</b>			
1 x Pg16 complete	HDC-HB-6-KVL1/16P	1202400000	5
1 x Pg16 sleeve	HDC-HB-6-KVL1/16	1653200000	5
1 x Pg21 complete	HDC-HBD-16-KVL1/21P	1653230000	5

Version	Type	Cat. No.	Qty.
<b>Standard housings</b>			
	HDC-HB-6-AVL	1202100000	5
<b>Standard housings with cover</b>			
	HDC-HB-6-ADVL	1202500000	5

KVL = Coupling hood, end locking

AVL = Bulkhead housing, end locking

ADVL = Bulkhead housing with cover, end locking

## Cover for plug hood

Cover with cord

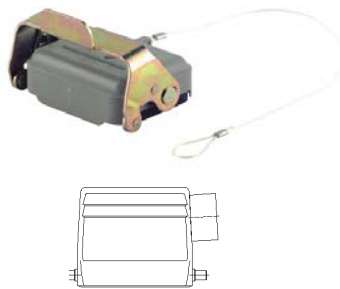

Type	Cat. No.	Qty.
<b>Plastic cover</b>		
HDC-HB-6-DT	1665210000	2

## Cover for lower side with end locking

Cover with cord

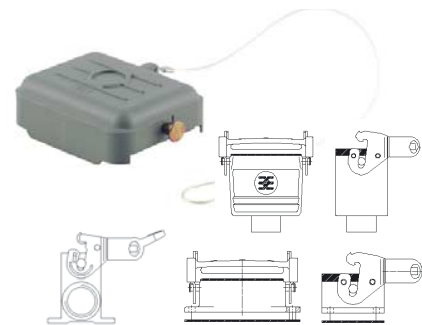

Type	Cat. No.	Qty.
<b>Plastic cover</b>		
HDC-HB-6-DB	1665200000	5

SVL = Base housing, end locking  
SDVL = Base housing with cover, end locking

For accessories see section "Accessories"



# Housings Group Size 4

## Plug hood HB-10

Side locking lower side



TOVU



TSVU

Dimensions

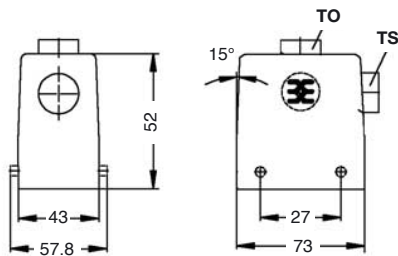

## Plug hood HBD-24

Side locking lower side / high version



TOVU



TSVU

Dimensions

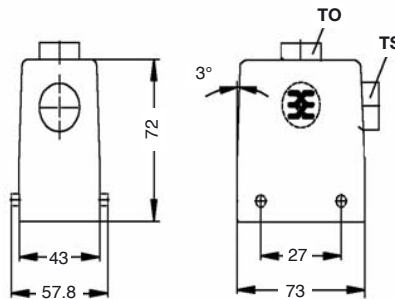

## Base housing HB-10 / HBD-24

Side locking



SVU



SVU

Dimensions

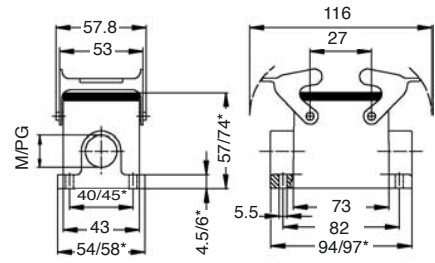

\*HB/HBD

Version	Type	Cat. No.	Qty.
<b>Standard housings, metric thread</b>			
1 x M 20 sleeve	HDC HB10 TSVU 1xM20	1787560000	5
1 x M 25 sleeve	HDC HB10 TSVU 1xM25	1787550000	5
1 x M 20 thread	HDC HB10 TOVU 1xM20G	1787600000	5
1 x M 25 thread	HDC HB10 TOVU 1xM25G	1787590000	5
<b>Standard housings, PG thread</b>			
1 x Pg16 complete	HDC-HB-10-TSVU1/16P	1204800000	5
1 x Pg16 sleeve	HDC-HB-10-TSVU1/16	1654070000	5
1 x Pg21 complete	HDC-HB-10-TSVU1/21P	1654080000	5
1 x Pg21 sleeve	HDC-HB-10-TSVU1/21	1654090000	5
1 x Pg16 complete	HDC-HB-10-TOVU1/16P	1204700000	5
1 x Pg16 sleeve	HDC-HB-10-TOVU1/16	1654220000	5
1 x Pg21 complete	HDC-HB-10-TOVU1/21P	1654230000	5
1 x Pg21 sleeve	HDC-HB-10-TOVU1/21	1654240000	5

TSVU = Plug hood; Side cable entry, side locking lower side  
 TOVU = Plug hood; Top cable entry, side locking lower side

Version	Type	Cat. No.	Qty.
<b>Standard housings, metric thread</b>			
1 x M 25 thread	HDC HBD24 TSVU 1xM25G	1787240000	5
1 x M 32 thread	HDC HBD24 TSVU 1xM32G	1787230000	5
1 x M 25 thread	HDC HBD24 TOVU 1xM25G	1787300000	5
1 x M 32 thread	HDC HBD24 TOVU 1xM32G	1787290000	5
<b>Standard housings, PG thread</b>			
1 x Pg21 complete	HDC-HBD-24-TSVU1/21P	1654140000	5
1 x Pg21 sleeve	HDC-HBD-24-TSVU1/21	1654150000	5
1 x Pg29 complete	HDC-HBD-24-TSVU1/29P	1654160000	5
1 x Pg29 sleeve	HDC-HBD-24-TSVU1/29	1654170000	5
1 x Pg21 complete	HDC-HBD-24-TOVU1/21P	1654290000	5
1 x Pg29 complete	HDC-HBD-24-TOVU1/29P	1654310000	5

TSVU = Plug hood; Side cable entry, side locking lower side  
 TOVU = Plug hood; Top cable entry, side locking lower side

Version	Type	Cat. No.	Qty.
<b>Standard housings, metric thread</b>			
1 x M 20 thread	HDC HB10 SVU 2xM20G	1787640000	2
1 x M 25 thread	HDC HB10 SVU 2xM25G	1787630000	2
2 x M 25 thread	HDC HBD24 SVU 2xM25G	1787350000	2
2 x M 32 thread	HDC HBD24 SVU 2xM32G	1787360000	2
<b>Standard housings, PG thread</b>			
1 x Pg16 complete	HDC-HB-10-SVU1/16P	1205100000	2
1 x Pg16 sleeve	HDC-HB-10-SVU1/16	1654370000	2
2 x Pg16 complete	HDC-HB-10-SVU2/16P	1205200000	2
2 x Pg16 sleeve	HDC-HB-10-SVU2/16	1654380000	2
1 x Pg21 complete	HDC-HBD-24-SVU1/21P	1654420000	2
1 x Pg21 sleeve	HDC-HBD-24-SVU1/21	1654430000	2
1 x Pg29 sleeve	HDC-HBD-24-SVU1/29	1654470000	2
2 x Pg21 complete	HDC-HBD-24-SVU2/21P	1654440000	2
2 x Pg21 sleeve	HDC-HBD-24-SVU2/21	1654450000	2
2 x Pg29 complete	HDC-HBD-24-SVU2/29P	1654480000	2

SVU = Base housing, side locking

For accessories see section "Accessories"



# Housings Group Size 4

## Coupling hood HB-10 / HBD 24

Side locking



KVU

KVU

### Dimensions

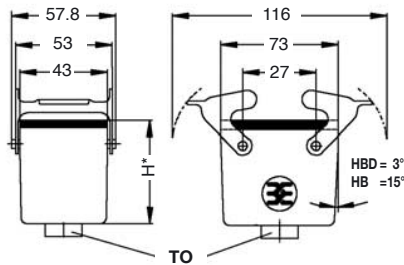

\*HB = 54.8  
HBD = 74.8

Version	Type	Cat. No.	Qty.
<b>Standard housings, metric thread</b>			
1 x M 20 thread	HDC HB10 KVU 1xM20G	1787720000	5
1 x M 25 thread	HDC HB10 KVU 1xM25G	1787710000	5
1 x M 25 thread	HDC HBD24 KVU 1xM25G	1787440000	2
1 x M 32 thread	HDC HBD24 KVU 1xM32G	1787430000	2
<b>Standard housings, PG thread</b>			
1 x Pg16 complete	HDC-HB-10-KVU1/16P	1205300000	5
1 x Pg16 sleeve	HDC-HB-10-KVU1/16	1654580000	5
1 x Pg21 complete	HDC-HB-10-KVU1/21P	1654590000	5
1 x Pg21 complete	HDC-HBD-24-KVU1/21P	1654650000	2
1 x Pg29 complete	HDC-HBD-24-KVU1/29P	1654670000	2

KVU = Coupling hood, side locking

## Cover for plug hood

Cover with cord



Type	Cat. No.	Qty.
<b>Plastic cover</b>		
HDC-HB-10-DT	1665240000	2

For accessories see section "Accessories"

## Bulkhead housing HB-10

Side locking



AVU

### Dimensions

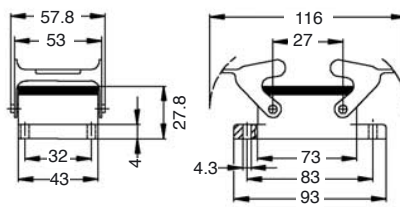

Version	Type	Cat. No.	Qty.
<b>Standard housings</b>			
	HDC-HB-10-AVU	1205000000	5

AVU = Bulkhead housing, side locking

## Cover for lower side with side locking

Cover with cord

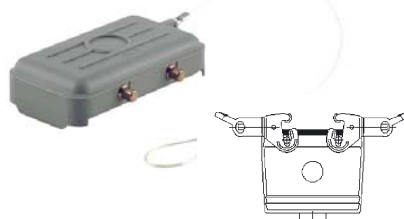

Type	Cat. No.	Qty.
<b>Plastic cover</b>		
HDC-HB-10-DB	1665230000	5

## Plug hood HB-10 / HBD-24

Side locking



TSVO

TSVO

### Dimensions

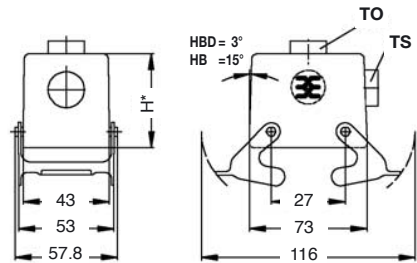

\*HB = 52  
HBD = 72

Version	Type	Cat. No.	Qty.
<b>Standard housings, metric thread</b>			
1 x M 25 sleeve	HDC HB10 TSVO 1xM25	1787570000	5
1 x M 25 thread	HDC HB10 TOVO 1xM25G	1787610000	5
1 x M 25 thread	HDC HBD24 TSVO 1xM25G	1787260000	2
1 x M 32 thread	HDC HBD24 TSVO 1xM32G	1787250000	2
1 x M 25 thread	HDC HBD24 TOVO 1xM25G	1787320000	2
1 x M 32 thread	HDC HBD24 TOVO 1xM32G	1787310000	2
<b>Standard housings, PG thread</b>			
1 x Pg16 complete	HDC-HB-10-TSVO1/16P	1205500000	5
1 x Pg16 sleeve	HDC-HB-10-TSVO1/16	1654750000	5
1 x Pg16 complete	HDC-HB-10-TOVO1/16P	1205400000	5
1 x Pg16 sleeve	HDC-HB-10-TOVO1/16	1654860000	5
1 x Pg21 sleeve	HDC-HBD-24-TSVO1/21	1654790000	2
1 x Pg29 complete	HDC-HBD-24-TSVO1/29P	1654800000	2
1 x Pg29 sleeve	HDC-HBD-24-TSVO1/29	1654810000	2
1 x Pg21 complete	HDC-HBD-24-TOVO1/21P	1654890000	2
1 x Pg29 complete	HDC-HBD-24-TOVO1/29P	1654910000	2
1 x Pg29 sleeve	HDC-HBD-24-TOVO1/29	1654920000	2

TSVO = Plug hood; Side cable entry, side locking

TOVO = Plug hood; Top cable entry, side locking

Series HD



# Housings Group Size 4

## Base housing HB-10 / HBD-24

Side locking upper side



SDVO

Dimensions

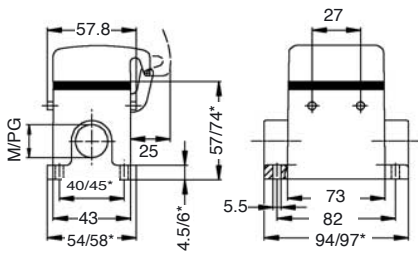

\*HB/HBD

Version	Type	Cat. No.	Qty.
<b>Standard housings with cover, metric thread</b>			
1 x M 20 thread	HDC HB10 SDVO 2xM20G	1787680000	2
1 x M 25 thread	HDC HB10 SDVO 2xM25G	1787670000	2
1 x M 25 thread	HDC HBD24 SDVO 2xM25G	1787400000	1
1 x M 32 thread	HDC HBD24 SDVO 2xM32G	1787390000	1
<b>Standard housings with cover, PG thread</b>			
1 x Pg16 complete	HDC-HB-10-SDVO1/16P	1205700000	2
1 x Pg16 sleeve	HDC-HB-10-SDVO1/16	1654990000	2
2 x Pg16 complete	HDC-HB-10-SDVO2/16P	1205800000	2
2 x Pg16 sleeve	HDC-HB-10-SDVO2/16	1655000000	2
1 x Pg21 complete	HDC-HBD-24-SDVO1/21P	1655050000	1
1 x Pg29 complete	HDC-HBD-24-SDVO1/29P	1655090000	1
2 x Pg29 complete	HDC-HBD-24-SDVO2/29P	1655110000	1

## Bulkhead housing HB-10

With cover / side locking upper side



ADVO

Dimensions

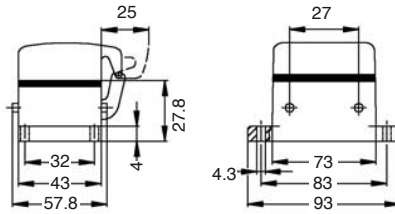

Version	Type	Cat. No.	Qty.
<b>Standard housings with cover</b>			
	HDC-HB-10-ADVO	1205600000	5
<b>ADVO = Bulkhead housing with cover, Side locking upper side</b>			

## Cover for plug hood with side locking

Cover with cord

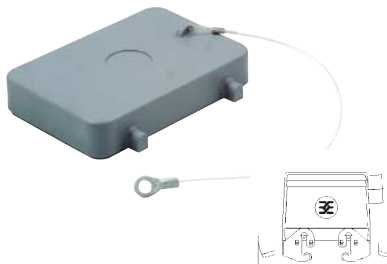

Type	Cat. No.	Qty.
<b>Plastic cover</b>		
HDC-HB-10-DBP	1665250000	5

SDVO = Base housing with cover, side locking upper side

## Plug hood HB-10 / HBD-24

End locking /lower side



TOVL



TOVL

Dimensions

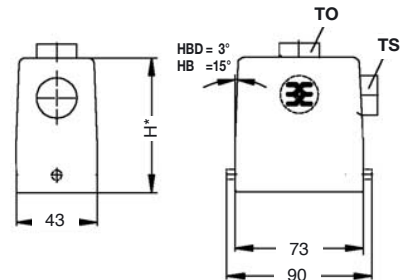

\*HB = 52  
HBD= 72

Version	Type	Cat. No.	Qty.
<b>Standard housings, metric thread</b>			
1 x M 25 sleeve	HDC HB10 TSVL 1xM25	1787580000	5
1 x M 25 thread	HDC HB10 TOVL 1xM25G	1787620000	5
1 x M 25 thread	HDC HBD24 TSVL 1xM25G	1787280000	2
1 x M 32 thread	HDC HBD24 TSVL 1xM32G	1787270000	2
1 x M 25 thread	HDC HBD24 TOVL 1xM25G	1787340000	2
1 x M 32 thread	HDC HBD24 TOVL 1xM32G	1787330000	2
<b>Standard housings, PG thread</b>			
1 x Pg16 complete	HDC-HB-10-TSVL1/16P	1206000000	5
1 x Pg16 sleeve	HDC-HB-10-TSVL1/16	1655210000	5
1 x Pg16 complete	HDC-HB-10-TOVL1/16P	1205900000	5
1 x Pg16 sleeve	HDC-HB-10-TOVL1/16	1655320000	5
1 x Pg21 complete	HDC-HBD-24-TSVL1/21P	1655240000	2
1 x Pg21 sleeve	HDC-HBD-24-TSVL1/21	1655250000	2
1 x Pg29 complete	HDC-HBD-24-TSVL1/29P	1655260000	2
1 x Pg29 sleeve	HDC-HBD-24-TSVL1/29	1655270000	2
1 x Pg21 complete	HDC-HBD-24-TOVL1/21P	1655350000	2
1 x Pg21 sleeve	HDC-HBD-24-TOVL1/21	1655360000	2
1 x Pg29 complete	HDC-HBD-24-TOVL1/29P	1655370000	2
1 x Pg29 sleeve	HDC-HBD-24-TOVL1/29	1655380000	2

TSVL = Plug hood; Side cable entry, end locking

TOVL = Plug hood; Top cable entry, end locking

For accessories see section "Accessories"

# Housings Group Size 4

## Base housing HB-10 / HBD-24

End locking, with/without cover



SVL



SDVL

## Coupling hood HB-10 / HBD-24

End locking



KVL



KVL

## Bulkhead housing HB-10

End locking, with/without cover



AVL



ADVL

Series HD

### Dimensions

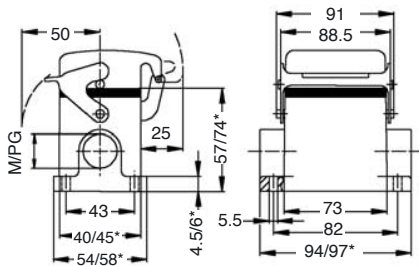

\*HB/HBG

Version	Type	Cat. No.	Qty.
<b>Standard housings, metric thread</b>			
2 x M 20 thread	HDC HB10 SVL 2xM20G	1787660000	2
2 x M 25 thread	HDC HB10 SVL 2xM25G	1787650000	2
2 x M 25 thread	HDC HBD24 SVL 2xM25G	1787380000	2
2 x M 32 thread	HDC HBD24 SVL 2xM32G	1787370000	2
<b>Standard housings with cover, metric thread</b>			
2 x M 20 thread	HDC HB10 SDVL 2xM20G	1787700000	2
2 x M 25 thread	HDC HB10 SDVL 2xM25G	1787690000	2
1 x M 25 thread	HDC HBD24 SDVL 1xM25G	1787420000	1
1 x M 32 thread	HDC HBD24 SDVL 1xM32G	1787410000	1
<b>Standard housings, PG thread</b>			
1 x Pg16 complete	HDC-HB-10-SVL1/16P	1206200000	2
1 x Pg16 sleeve	HDC-HB-10-SVL1/16	1655460000	2
2 x Pg16 complete	HDC-HB-10-SVL2/16P	1206300000	2
2 x Pg16 sleeve	HDC-HB-10-SVL2/16	1655470000	2
1 x Pg21 complete	HDC-HBD-24-SVL1/21P	1655510000	2
1 x Pg29 complete	HDC-HBD-24-SVL1/29P	1655550000	2
<b>Standard housings with cover, PG thread</b>			
1 x Pg16 complete	HDC-HB-10-SDVL1/16P	1206600000	2
1 x Pg16 sleeve	HDC-HB-10-SDVL1/16	1655670000	2
2 x Pg16 complete	HDC-HB-10-SDVL2/16P	1206700000	1
2 x Pg16 sleeve	HDC-HB-10-SDVL2/16	1655680000	1
1 x Pg21 complete	HDC-HBD-24-SDVL1/21P	1655720000	1

SVL = Base housing, end locking  
SDVL = Base housing with cover, end locking

### Dimensions

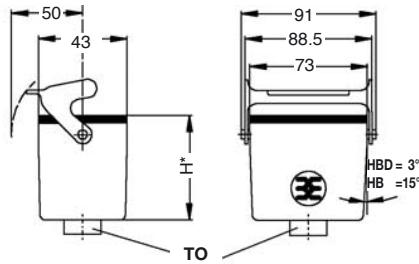

\*HB = 54.8  
HBD = 74.8

Version	Type	Cat. No.	Qty.
<b>Standard housings, metric thread</b>			
1 x M 20 thread	HDC HB10 KVL 1xM20G	1787740000	5
1 x M 25 thread	HDC HB10 KVL 1xM25G	1787730000	2
1 x M 25 thread	HDC HBD24 KVL 1xM25G	1787460000	2
1 x M 32 thread	HDC HBD24 KVL 1xM32G	1787450000	2
<b>Standard housings, PG thread</b>			
1 x Pg16 complete	HDC-HB-10-KVL1/16P	1655880000	5
1 x Pg16 sleeve	HDC-HB-10-KVL1/16	1655890000	5
1 x Pg21 complete	HDC-HB-10-KVL1/21P	1655900000	2

KVL = Coupling hood, end locking

### Dimensions

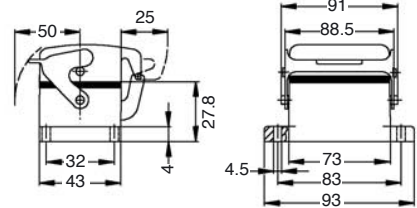

Version	Type	Cat. No.	Qty.
<b>Standard housings</b>			
	HDC-HB-10-AVL	1206100000	5
<b>Standard housings with cover</b>			
	HDC-HB-10-ADVL	1206500000	2

AVL = Bulkhead housing, end locking  
ADVL = Bulkhead housing with cover, end locking

For accessories see section "Accessories"

# Inserts Group Size 5

## Crimp connection series HD-25

25-pole

250 V-/max 10 A



Male



Female

### Dimensions

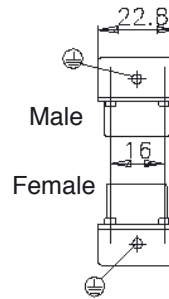
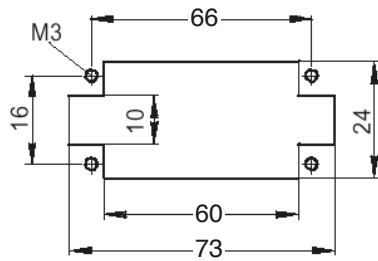
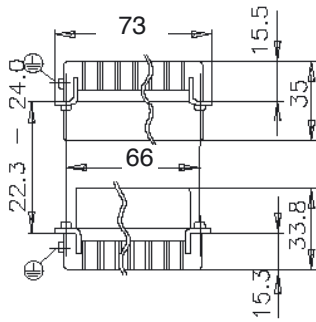

Male

Female

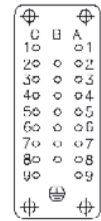
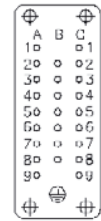

View from cable side

Version	Type	Cat. No.	Qty.
<b>For stamped contacts</b>			
Male	HDC-HD-25SCG	1650790000	5
<b>For turned contacts</b>			
Male	HDC-HD-25SCM	1650810000	5

Version	Type	Cat. No.	Qty.
<b>For stamped contacts</b>			
Female	HDC-HD-25BCG	1650800000	5
<b>For turned contacts</b>			
Female	HDC-HD-25BCM	1650820000	5

For crimp contacts see page 62 and 63

For crimp contacts see page 62 and 63

For accessories see section "Accessories"

# Housings Group Size 5

## Plug hood HA-16 / HAD-25

End locking / lower side



TOVL



TSVL

## Base housing HA-16

End locking, with/without cover



SVL



SDVL

## Coupling hood HA-16 / HAD-25

End locking



KVL

### Dimensions

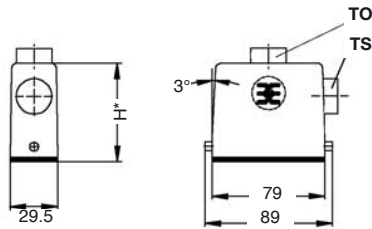

\*HA = 58.3  
HAD= 72.3

Version	Type	Cat. No.	Qty.
<b>Standard housings, metric thread</b>			
1 x M 20 thread	HDC HA16 TOVL 1xM20G	1804680000	5
1 x M 25 thread	HDC HA16 TOVL 1xM25G	1788750000	5
1 x M 20 sleeve	HDC HA16 TSVL 1xM20	1804620000	5
1 x M 25 sleeve	HDC HA16 TSVL 1xM25	1788740000	5
1 x M 20 thread	HDC HAD25 TOVL 1xM20G	1788710000	5
1 x M 25 thread	HDC HAD25 TOVL 1xM25G	1788700000	5
1 x M 25 thread	HDC HAD25 TSVL 1xM25G	1788690000	5
1 x M 32 thread	HDC HAD25 TSVL 1xM32G	1788680000	5
<b>Standard housings, PG thread</b>			
1 x Pg16 complete	HDC-HA-16-TOVL1/16P	1664800000	5
1 x Pg16 sleeve	HDC-HA-16-TOVL1/16	1664810000	5
1 x Pg16 complete	HDC-HA-16-TSVL1/16P	1664680000	5
1 x Pg16 sleeve	HDC-HA-16-TSVL1/16	1664690000	5
1 x Pg16 complete	HDC-HAD-25-TOVL1/16P	1664840000	5
1 x Pg16 sleeve	HDC-HAD-25-TOVL1/16	1664850000	5
1 x Pg21 complete	HDC-HAD-25-TOVL1/21P	1664860000	5
1 x Pg21 sleeve	HDC-HAD-25-TOVL1/21	1664870000	5
1 x Pg16 complete	HDC-HAD-25-TSVL1/16P	1664720000	5
1 x Pg16 sleeve	HDC-HAD-25-TSVL1/16	1664730000	5
1 x Pg21 complete	HDC-HAD-25-TSVL1/21P	1664740000	5
1 x Pg21 sleeve	HDC-HAD-25-TSVL1/21	1664750000	5

TOVL = Plug hood; Top cable entry, end locking  
TSVL = Plug hood; Side cable entry, end locking

### Dimensions

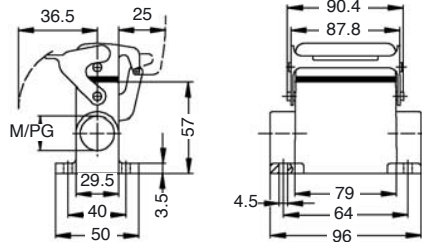

Version	Type	Cat. No.	Qty.
<b>Standard housings, metric thread</b>			
2 x M 20 thread	HDC HA16 SVL 2xM20G	1788770000	2
2 x M 25 thread	HDC HA16 SVL 2xM25G	1788760000	2
<b>Standard housings with cover, metric thread</b>			
2 x M 20 thread	HDC HA16 SDVL 2xM20G	1788790000	2
2 x M 25 thread	HDC HA16 SDVL 2xM25G	1788780000	2
<b>Standard housings, PG thread</b>			
1 x Pg16 complete	HDC-HA-16-SVL1/16P	1665040000	2
1 x Pg16 sleeve	HDC-HA-16-SVL1/16	1665050000	2
1 x Pg21 complete	HDC-HA-16-SVL1/21P	1665080000	2
1 x Pg21 sleeve	HDC-HA-16-SVL1/21	1665090000	2
2 x Pg16 complete	HDC-HA-16-SVL2/16P	1665060000	2
2 x Pg16 sleeve	HDC-HA-16-SVL2/16	1665070000	2
2 x Pg21 complete	HDC-HA-16-SVL2/21P	1665100000	2
<b>Standard housings with cover, PG thread</b>			
1 x Pg16 complete	HDC-HA-16-SDVL1/16P	1665280000	2
2 x Pg16 complete	HDC-HA-16-SDVL2/16P	1665300000	2

SVL = Base housing, end locking  
SDVL = Base housing with cover, end locking

### Dimensions

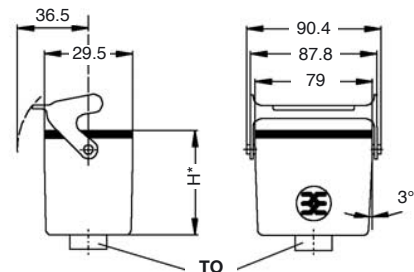

\*HA = 53  
HAD= 67

Version	Type	Cat. No.	Qty.
<b>Standard housings, metric thread</b>			
1 x M 25 thread	HDC HA16 KVL 1xM25G	1788800000	5
1 x M 20 thread	HDC HAD25 KVL 1xM20G	1788730000	2
1 x M 25 thread	HDC HAD25 KVL 1xM25G	1788720000	2
<b>Standard housings, PG thread</b>			
1 x Pg16 complete	HDC-HA-16-KVL1/16P	1665440000	5
1 x Pg16 sleeve	HDC-HA-16-KVL1/16	1665450000	5
1 x Pg16 complete	HDC-HAD-25-KVL1/16P	1665480000	2
1 x Pg21 complete	HDC-HAD-25-KVL1/21P	1665500000	2

KVL = Coupling hood, end locking

Series HD

For accessories see section "Accessories"

# Housings Group Size 5

## Bulkhead housing HA-16

End locking / with/without cover



AVL



ADVL

### Dimensions

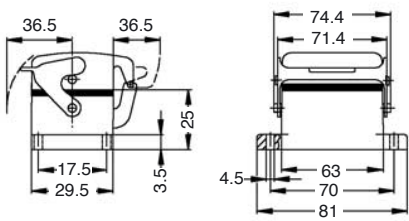

## Cover for plug hood

Cover with cord



## Cover for housing with end locking

Cover with cord



Version	Type	Cat. No.	Qty.
<b>Standard housings</b>			
	HDC-HA-16-AVL	1664920000	5
<b>Standard housings with cover</b>			
	HDC-HA-16-ADVL	1664940000	5

Type	Cat. No.	Qty.
<b>Plastic cover</b>		
HDC-HA-16-KDF	1665910000	5

Type	Cat. No.	Qty.
<b>Plastic cover</b>		
HDC-HA-16-KDBF	1665900000	5

AVL = Bulkhead housing, end locking  
 ADVL = Bulkhead housing with cover, end locking

For accessories see section "Accessories"

# Inserts Group Size 6

## Crimp connection series HD-40

40-pole

250 V-/max 10 A

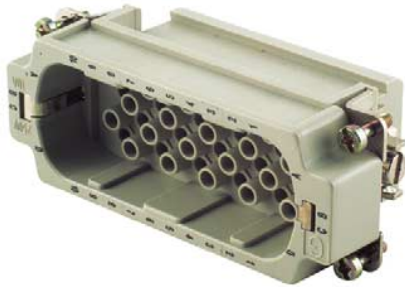

Male



Female

Series HD

### Dimensions

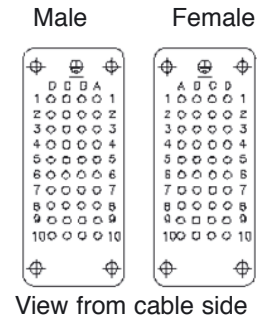
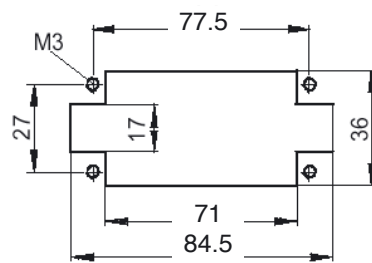
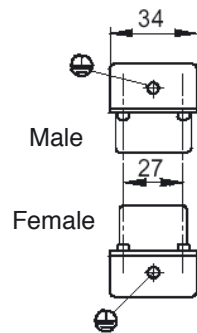
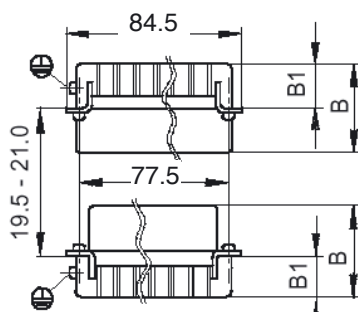

Version	Type	Cat. No.	Qty.
<b>For stamped contacts</b>			
Male	HDC-HD-40SCG	1572560000	5
<b>For turned contacts</b>			
Male	HDC-HD-40SCM	1601710000	5

Version	Type	Cat. No.	Qty.
<b>For stamped contacts</b>			
Female	HDC-HD-40BCG	1572570000	5
<b>For turned contacts</b>			
Female	HDC-HD-40BCM	1601730000	5

For crimp contacts see page 62 and 63

For crimp contacts see page 62 and 63

For accessories see section "Accessories"



# Housings Group Size 6

## Plug hood HB-16 / HBD-40

Side locking lower side



TSVU



TOVU

Dimensions

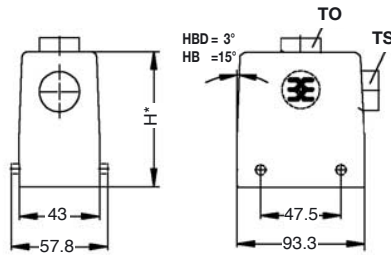

\*HB = 61  
HBD = 76

Version	Type	Cat. No.	Qty.
<b>Standard housings, metric thread</b>			
1 x M 25 sleeve	HDC HB16 TSVU 1xM25	1788180000	5
1 x M 25 thread	HDC HB16 TOVU 1xM25G	1788210000	5
1 x M 25 thread	HDC HBD40 TSVU 1xM25G	1787010000	5
1 x M 32 thread	HDC HBD40 TSVU 1xM32G	1787000000	5
1 x M 25 thread	HDC HBD40 TOVU 1xM25G	1787070000	5
1 x M 32 thread	HDC HBD40 TOVU 1xM32G	1787060000	5
<b>Standard housings, PG thread</b>			
1 x Pg21 complete	HDC-HB-16-TSVU1/21P	1208400000	5
1 x Pg21 sleeve	HDC-HB-16-TSVU1/21	1656480000	5
1 x Pg21 complete	HDC-HB-16-TOVU1/21P	1208300000	5
1 x Pg21 sleeve	HDC-HB-16-TOVU1/21	1656590000	5
1 x Pg21 complete	HDC-HBD-40-TSVU1/21P	1656510000	5
1 x Pg21 sleeve	HDC-HBD-40-TSVU1/21	1656520000	5
1 x Pg29 complete	HDC-HBD-40-TSVU1/29P	1656530000	5
1 x Pg29 sleeve	HDC-HBD-40-TSVU1/29	1656540000	5
1 x Pg21 complete	HDC-HBD-40-TOVU1/21P	1656620000	5
1 x Pg21 sleeve	HDC-HBD-40-TOVU1/21	1656630000	5
1 x Pg29 complete	HDC-HBD-40-TOVU1/29P	1656640000	5
1 x Pg29 sleeve	HDC-HBD-40-TOVU1/29	1656650000	5

**TOVU** = Plug hood; Top cable entry, side locking lower side  
**TSVU** = Plug hood; Side cable entry, side locking lower side

For accessories see section "Accessories"

## Base housing HB-16 / HBD-40

Side locking



SVU

Dimensions

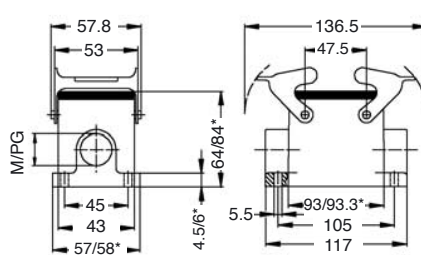

\*HB/HBD

Version	Type	Cat. No.	Qty.
<b>Standard housings, metric thread</b>			
1 x M 25 thread	HDC HB16 SVU 2xM25G	1788240000	2
2 x M 25 thread	HDC HBD40 SVU 2xM25G	1787120000	2
2 x M 32 thread	HDC HBD40 SVU 2xM32G	1787110000	2
<b>Standard housings, PG thread</b>			
1 x Pg21 complete	HDC-HB-16-SVU1/21P	1208700000	2
1 x Pg21 sleeve	HDC-HB-16-SVU1/21	1656720000	2
2 x Pg21 complete	HDC-HB-16-SVU2/21P	1208800000	2
2 x Pg21 sleeve	HDC-HB-16-SVU2/21	1656730000	2
1 x Pg21 sleeve	HDC-HBD-40-SVU1/21	1656790000	2
1 x Pg29 complete	HDC-HBD-40-SVU1/29P	1656820000	2
2 x Pg21 complete	HDC-HBD-40-SVU2/21P	1656800000	2
2 x Pg21 sleeve	HDC-HBD-40-SVU2/21	1656810000	2
2 x Pg29 complete	HDC-HBD-40-SVU2/29P	1656840000	2

**SVU** = Base housing, side locking lower side

## Coupling hood HB-16 / HBD-40

Side locking



KVVU

Dimensions

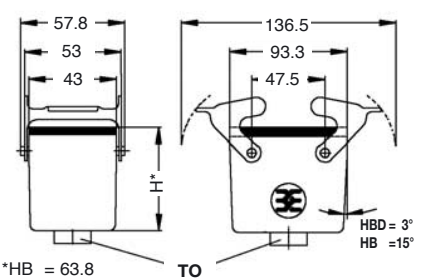

\*HB = 63.8  
HBD = 78.8

Version	Type	Cat. No.	Qty.
<b>Standard housings, metric thread</b>			
1 x M 25 thread	HDC HBD40 KVVU 1xM25G	1787200000	2
1 x M 32 thread	HDC HBD40 KVVU 1xM32G	1787190000	2
1 x M 25 thread	HDC HB16 KVVU 1xM25G	1788280000	2
<b>Standard housings, PG thread</b>			
1 x Pg21 complete	HDC-HB-16-KVVU1/21P	1208900000	2
1 x Pg21 sleeve	HDC-HB-16-KVVU1/21	1657270000	2
1 x Pg21 complete	HDC-HBD-40-KVVU1/21P	1657300000	2
1 x Pg21 sleeve	HDC-HBD-40-KVVU1/21	1657310000	2
1 x Pg29 complete	HDC-HBD-40-KVVU1/29P	1657320000	2

**KVVU** = Coupling hood, Side locking

## Cover for plug hood

Cover with cord



Type	Cat. No.	Qty.
<b>Plastic cover</b>		
HDC-HB-16-DT	1665270000	2

# Housings Group Size 6

## Bulkhead housing HB-16

Side locking



AVU

## Plug hood HB-16 / HBD-40

Side locking



TSVO



TOVO

## Base housing HB-16 / HBD-40

Side locking upper side



SDVO

### Dimensions

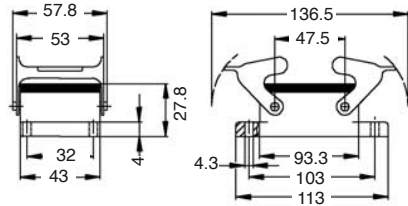

### Dimensions

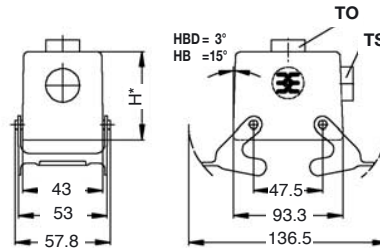

\*HB = 61  
HBD = 76

### Dimensions

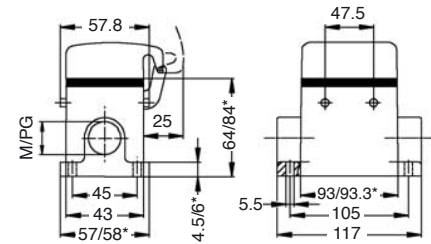

Version	Type	Cat. No.	Qty.
<b>Standard housings</b>			
	HDC-HB-16-AVU	120860000	5
AVU = Bulkhead housing, side locking			

Version	Type	Cat. No.	Qty.
<b>Standard housings, metric thread</b>			
1 x M 25 sleeve	HDC HB16 TSVO 1xM25	1788190000	2
1 x M 25 thread	HDC HB16 TOVO 1xM25G	1788220000	2
1 x M 25 thread	HDC HBD40 TSVO 1xM25G	1787030000	2
1 x M 32 thread	HDC HBD40 TSVO 1xM32G	1787020000	2
1 x M 25 thread	HDC HBD40 TOVO 1xM25G	1787090000	2
1 x M 32 thread	HDC HBD40 TOVO 1xM32G	1787080000	2
<b>Standard housings, PG thread</b>			
1 x Pg21 complete	HDC-HB-16-TSVO1/21P	1209100000	2
1 x Pg21 sleeve	HDC-HB-16-TSVO1/21	1657380000	2
1 x Pg21 complete	HDC-HB-16-TOVO1/21P	1209000000	2
1 x Pg21 sleeve	HDC-HB-16-TOVO1/21	1657490000	2
1 x Pg29 complete	HDC-HBD-40-TSVO1/29P	1657430000	2
1 x Pg21 complete	HDC-HBD-40-TOVO1/21P	1657520000	2
1 x Pg29 complete	HDC-HBD-40-TOVO1/29P	1657540000	2
1 x Pg29 sleeve	HDC-HBD-40-TOVO1/29	1657550000	2

Version	Type	Cat. No.	Qty.
<b>Standard housings with cover, metric thread</b>			
2 x M 25 thread	HDC HB16 SDVO 2xM25G	1788260000	2
2 x M 25 thread	HDC HBD40 SDVO 2xM25G	1787160000	2
2 x M 32 thread	HDC HBD40 SDVO 2xM32G	1787150000	2
<b>Standard housings with cover, PG thread</b>			
1 x Pg21 complete	HDC-HB-16-SDVO1/21P	1209300000	2
2 x Pg21 complete	HDC-HB-16-SDVO2/21P	1209400000	2
2 x Pg21 sleeve	HDC-HB-16-SDVO2/21	1657640000	2
1 x Pg21 complete	HDC-HBD-40-SDVO1/21P	1657690000	2
1 x Pg21 sleeve	HDC-HBD-40-SDVO1/21	1657700000	2
2 x Pg21 complete	HDC-HBD-40-SDVO2/21P	1657710000	2

## Cover for lower side with side locking

Cover with cord

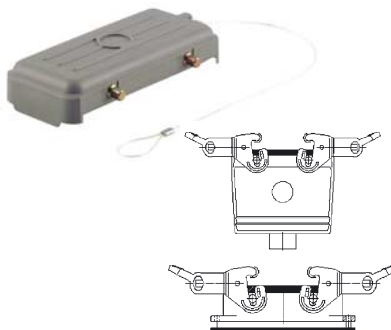

Type	Cat. No.	Qty.
<b>Plastic cover</b>		
HDC-HB-16-DB	1665260000	2

For accessories see section "Accessories"

**TSVO** = Plug hood; Side cable entry, side locking  
**TOVO** = Plug hood; Top cable entry, side locking

**SDVO** = Base housing with cover, side locking upper side

Series HD



# Housings Group Size 6

## Bulkhead housing HB-16

Side locking upper side



ADVO

## Plug hood HB-16 / HBD-40

End locking / lower side / high version



TOVL

## Base housing HB-16 / HBD-40

End locking with/without cover



SVL



TSVL



SDVL

### Dimensions

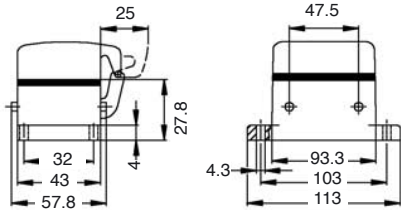

### Dimensions

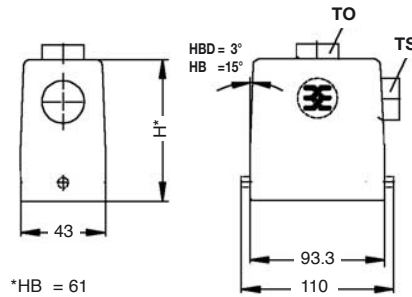

\*HB = 61  
HBD= 76

### Dimensions

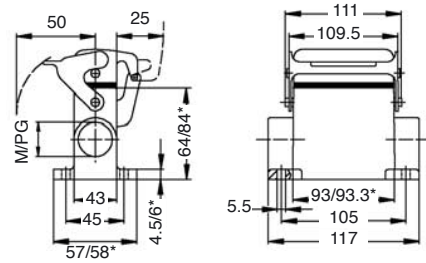

\*HB/HBD

Version	Type	Cat. No.	Qty.
<b>Standard housings</b>			
	HDC-HB-16-ADVO	1209200000	2
ADVL = Bulkhead housing with cover, side locking			

Version	Type	Cat. No.	Qty.
<b>Standard housings, metric thread</b>			
1 x M 25 sleeve	HDC HB16 TSVL 1xM25	1788200000	5
1 x M 25 thread	HDC HB16 TOVL 1xM25G	1788230000	5
1 x M 32 thread	HDC HB16 TSVL 1xM32G	1804640000	5
1 x M 32 thread	HDC HB16 TOVL 1xM32G	1804630000	5
1 x M 25 thread	HDC HBD40 TSVL 1xM25G	1787050000	5
1 x M 32 thread	HDC HBD40 TSVL 1xM32G	1787040000	5
1 x M 32 thread	HDC HBD40 TOVL 1xM32G	1787100000	5

Version	Type	Cat. No.	Qty.
<b>Standard housings, metric thread</b>			
2 x M 25 thread	HDC HB16 SVL 2xM25G	1788250000	2
2 x M 25 thread	HDC HBD40 SVL 2xM25G	1787140000	2
2 x M 32 thread	HDC HBD40 SVL 1xM32G	1804660000	2
2 x M 32 thread	HDC HBD40 SVL 2xM32G	1787130000	2
2 x M 25 thread	HDC HB16 SDVL 2xM25G	1788270000	2
2 x M 25 thread	HDC HBD40 SDVL 2xM25G	1787180000	2
2 x M 32 thread	HDC HBD40 SDVL 2xM32G	1787170000	2

## Cover for plug hood with side locking

Cover with cord

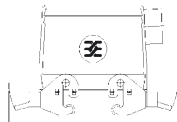

Type	Cat. No.	Qty.
<b>Plastic cover</b>		
HDC-HB-16-DBP	1665620000	5

TSVL = Plug hood; Side cable entry, end locking lower side  
TOVL = Plug hood; Top cable entry, end locking lower side

SVL = Base housing, end locking  
SDVL = Base housing with cover, end locking

For accessories see section "Accessories"

# Housings Group Size 6

## Coupling hood HB-16 / HBD-40

End locking



KVL

## Bulkhead housing HB-16

End locking



AVL



ADVL

### Dimensions

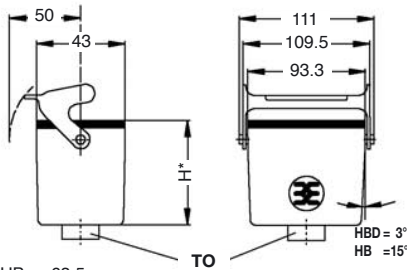

\*HB = 63.5  
HBD = 78.5

Version	Type	Cat. No.	Qty.
<b>Standard housings, metric thread</b>			
1 x M 25 thread	HDC HB16 KVL 1xM25G	1788290000	2
1 x M 25 thread	HDC HBD40 KVL 1xM25G	1787220000	2
1 x M 32 thread	HDC HBD40 KVL 1xM32G	1787210000	2
<b>Standard housings, PG thread</b>			
1 x Pg21 complete	HDC-HB-16-KVL1/21P	1210000000	2
1 x Pg29 complete	HDC-HBD-40-KVL1/29P	1658580000	2

KVL = Coupling hood, end locking

### Dimensions

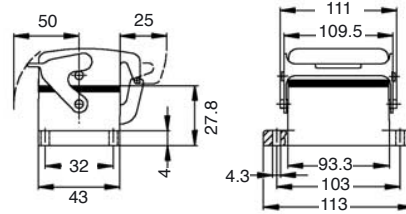

Version	Type	Cat. No.	Qty.
<b>Standard housings</b>			
	HDC-HB-16-AVL	1209700000	5
<b>Standard housings with cover</b>			
	HDC-HB-16-ADVL	1210100000	2
<b>AVL = Bulkhead housing, end locking</b>			
<b>ADVL = Bulkhead housing with cover, end locking</b>			

Series HD

For accessories see section "Accessories"





# Housings Group Size 7

## Plug hood HA-32

Side locking lower side



TOVU



TSVU

Dimensions

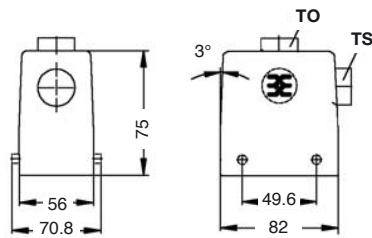

## Base housing HA-32

Side locking



SVU

Dimensions

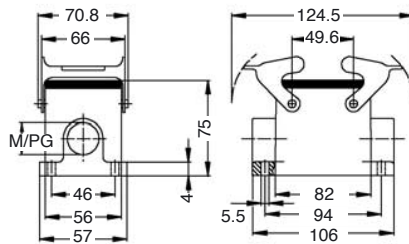

## Coupling hood HA-32

Side locking



KVVU

Dimensions

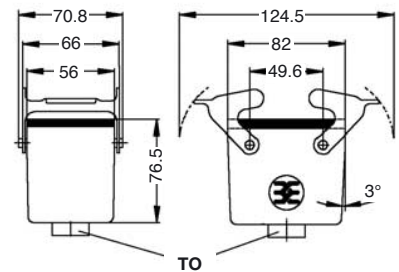

Version	Type	Cat. No.	Qty.
<b>Standard housings, metric thread</b>			
1 x M 25 thread	HDC HA32 TOVU 1xM25G	1788000000	2
1 x M 32 thread	HDC HA32 TOVU 1xM32G	1787990000	2
1 x M 25 thread	HDC HA32 TSVU 1xM25G	1787960000	2
1 x M 32 thread	HDC HA32 TSVU 1xM32G	1787950000	2
<b>Standard housings, PG thread</b>			
1 x Pg21 complete	HDC-HA-32-TOVU1/21P	1665780000	2
1 x Pg21 sleeve	HDC-HA-32-TOVU1/21	1665790000	2
1 x Pg29 complete	HDC-HA-32-TOVU1/29P	1665800000	2
1 x Pg29 sleeve	HDC-HA-32-TOVU1/29	1665810000	2
1 x Pg21 complete	HDC-HA-32-TSVU1/21P	1665660000	2
1 x Pg21 sleeve	HDC-HA-32-TSVU1/21	1665670000	2
1 x Pg29 complete	HDC-HA-32-TSVU1/29P	1665680000	2
1 x Pg29 sleeve	HDC-HA-32-TSVU1/29	1665690000	2

TOVU = Plug hood; Top cable entry, side locking lower side

TSVU = Plug hood; Side cable entry, side locking lower side

Version	Type	Cat. No.	Qty.
<b>Standard housings, metric thread</b>			
2 x M 25 thread	HDC HA32 SVU 2xM25G	1788040000	2
2 x M 32 thread	HDC HA32 SVU 2xM32G	1788030000	2
<b>Standard housings, PG thread</b>			
1 x Pg21 complete	HDC-HA-32-SVU1/21P	1665960000	2
1 x Pg29 complete	HDC-HA-32-SVU1/29P	1666000000	2
1 x Pg29 sleeve	HDC-HA-32-SVU1/29	1666010000	2
2 x Pg21 complete	HDC-HA-32-SVU2/21P	1665980000	2
2 x Pg29 complete	HDC-HA-32-SVU2/29P	1666020000	2

SVU = Base housing, side locking lower side

Version	Type	Cat. No.	Qty.
<b>Standard housings, metric thread</b>			
1 x M 25 thread	HDC HA32 KVVU 1xM25G	1788080000	2
1 x M 32 thread	HDC HA32 KVVU 1xM32G	1788070000	2
<b>Standard housings, PG thread</b>			
1 x Pg21 complete	HDC-HA-32-KVVU1/21P	1666120000	2
1 x Pg29 complete	HDC-HA-32-KVVU1/29P	1666140000	2

KVVU = Coupling hood, side locking

For accessories see section "Accessories"

# Housings Group Size 7

## Bulkhead housing HA-32

Side locking



AVU

### Dimensions

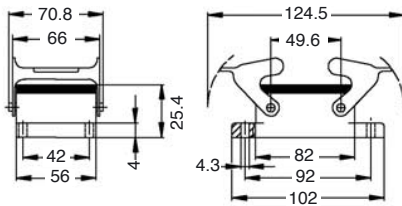

Version	Type	Cat. No.	Qty.
<b>Standard housings</b>			
	HDC-HA-32-AVU	1665860000	2

AVU = Bulkhead housing, side locking lower side

For accessories see section "Accessories"

Series HD

# Inserts Group Size 8

## Crimp connection series HD-64

64-pole

250 V-/max 10 A

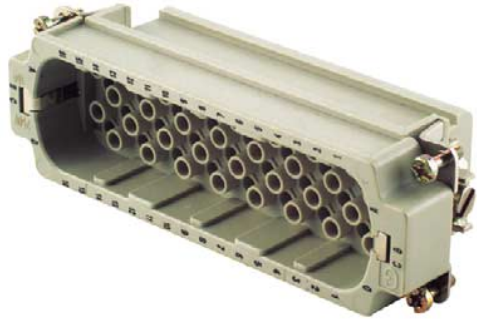

Male



Female

### Dimensions

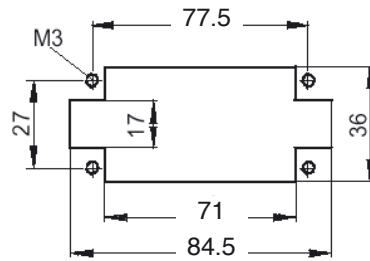
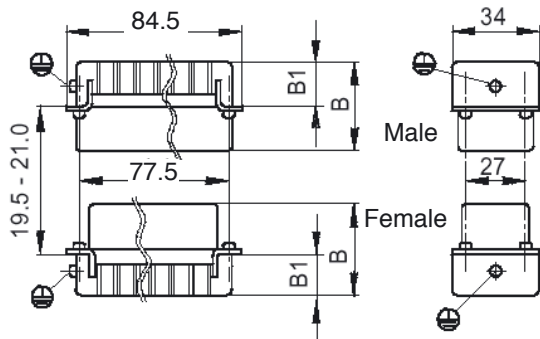

Male Female

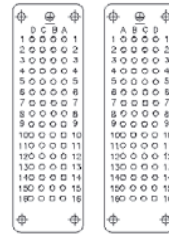

View from cable side

Version	Type	Cat. No.	Qty.
<b>For stamped contacts</b>			
Male	HDC-HD-64SCG	1572580000	5
<b>For turned contacts</b>			
Male	HDC-HD-64SCM	1601720000	5

Version	Type	Cat. No.	Qty.
<b>For stamped contacts</b>			
Female	HDC-HD-64BCG	1572590000	5
<b>For turned contacts</b>			
Female	HDC-HD-64BCM	1601740000	5

For crimp contacts see page 62 and 63

For crimp contacts see page 62 and 63

For accessories see section "Accessories"



# Housings Group Size 8

## Plug hood HB-24

Side locking lower side



TOVU



TSVU

## Plug hood HBD-64

Side locking lower side / high version



TOVU



TSVU

## Base housing HB-24 / HBD-64

Side locking



SVU

### Dimensions

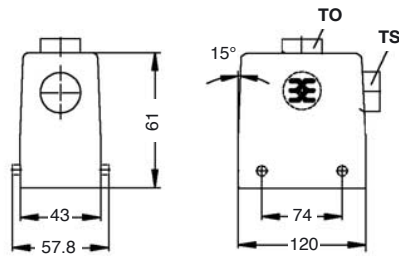

### Dimensions

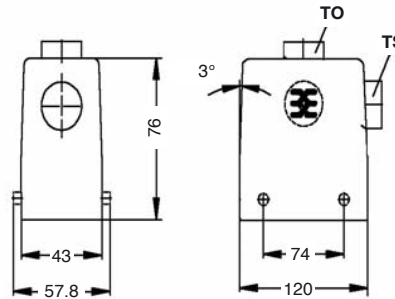

### Dimensions

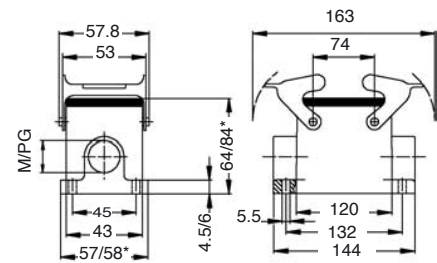

\*HB/HBD

Version	Type	Cat. No.	Qty.
<b>Standard housings, metric thread</b>			
1 x M 25 thread	HDC HB24 TOVU 1xM25G	1787820000	2
1 x M 32 sleeve	HDC HB24 TSVU 1xM32	1787750000	2
1 x M 25 sleeve	HDC HB24 TSVU 1xM25	1787760000	2
1 x M 32 thread	HDC HB24 TOVU 1xM32G	1787810000	2
<b>Standard housings, PG thread</b>			
1 x Pg21 complete	HDC-HB-24-TSVU1/21P	1212100000	2
1 x Pg21 sleeve	HDC-HB-24-TSVU1/21	1661230000	2
1 x Pg29 complete	HDC-HB-24-TSVU1/29P	1212200000	2
1 x Pg29 sleeve	HDC-HB-24-TSVU1/29	1661240000	2
1 x Pg21 complete	HDC-HB-24-TOVU1/21P	1211900000	2
1 x Pg21 sleeve	HDC-HB-24-TOVU1/21	1661370000	2
1 x Pg29 complete	HDC-HB-24-TOVU1/29P	1212000000	2
1 x Pg29 sleeve	HDC-HB-24-TOVU1/29	1661380000	2

TOVU = Plug hood; Top cable entry, side locking lower side

TSVU = Plug hood; Side cable entry, side locking lower side

Version	Type	Cat. No.	Qty.
<b>Standard housings, metric thread</b>			
1 x M 25 thread	HDC HBD64 TSVU 1xM25G	1786780000	2
1 x M 32 thread	HDC HBD64 TSVU 1xM32G	1786770000	2
1 x M 25 thread	HDC HBD64 TOVU 1xM25G	1786840000	2
1 x M 32 thread	HDC HBD64 TOVU 1xM32G	1786830000	2
<b>Standard housings, PG thread</b>			
1 x Pg21 complete	HDC-HBD-64-TSVU1/21P	1661290000	2
1 x Pg21 sleeve	HDC-HBD-64-TSVU1/21	1661300000	2
1 x Pg29 complete	HDC-HBD-64-TSVU1/29P	1661310000	2
1 x Pg29 sleeve	HDC-HBD-64-TSVU1/29	1661320000	2
1 x Pg21 complete	HDC-HBD-64-TOVU1/21P	1661430000	2
1 x Pg21 sleeve	HDC-HBD-64-TOVU1/21	1661440000	2
1 x Pg29 complete	HDC-HBD-64-TOVU1/29P	1661450000	2
1 x Pg29 sleeve	HDC-HBD-64-TOVU1/29	1661460000	2

TOVU = Plug hood; Top cable entry, side locking lower side

TSVU = Plug hood; Side cable entry, side locking lower side

Version	Type	Cat. No.	Qty.
<b>Standard housings, metric thread</b>			
2 x M 25 thread	HDC HB24 SVU 2xM25G	1787870000	2
2 x M 25 thread	HDC HBD64 SVU 2xM25G	1786890000	2
2 x M 32 thread	HDC HBD64 SVU 2xM32G	1786880000	2
<b>Standard housings, PG thread</b>			
1 x Pg21 complete	HDC-HB-24-SVU1/21P	1212500000	2
1 x Pg21 sleeve	HDC-HB-24-SVU1/21	1661510000	2
2 x Pg21 complete	HDC-HB-24-SVU2/21P	1212600000	2
2 x Pg21 sleeve	HDC-HB-24-SVU2/21	1661520000	2
1 x Pg21 complete	HDC-HBD-64-SVU1/21P	1661560000	2
1 x Pg21 sleeve	HDC-HBD-64-SVU1/21	1661570000	2
1 x Pg29 complete	HDC-HBD-64-SVU1/29P	1661600000	2
1 x Pg29 sleeve	HDC-HBD-64-SVU1/29	1661610000	2
2 x Pg21 complete	HDC-HBD-64-SVU2/21P	1661580000	2
2 x Pg21 sleeve	HDC-HBD-64-SVU2/21	1661590000	2
2 x Pg29 complete	HDC-HBD-64-SVU2/29P	1661620000	2
2 x Pg29 sleeve	HDC-HBD-64-SVU2/29	1661630000	2

SVU = Base housing, side locking

For accessories see section "Accessories"

Series HD





# Housings Group Size 8

## Base housing HB-24 / HBD-64

Side locking upper side

Group size 8



SDVO

## Bulkhead housing HB-24

Side locking upper side

Group size 8



ADVO

## Cover for plug hood with side locking

Cover with cord



### Dimensions

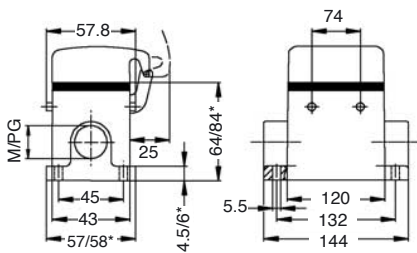

\*HB/HBD

### Dimensions

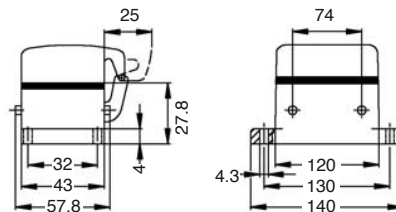

### Dimensions

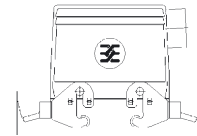

Version	Type	Cat. No.	Qty.
<b>Standard housings with cover, metric thread</b>			
2 x M 25 thread	HDC HB24 SDVO 2xM25G	1787890000	2
2 x M 25 thread	HDC HBD64 SDVO 2xM25G	1786930000	2
2 x M 32 thread	HDC HBD64 SDVO 2xM32G	1786920000	2
<b>Standard housings with cover, metric thread</b>			
1 x Pg21 complete	HDC-HB-24-SDVO1/21P	1213400000	2
1 x Pg21 sleeve	HDC-HB-24-SDVO1/21	1662170000	2
2 x Pg21 complete	HDC-HB-24-SDVO2/21P	1213500000	2
2 x Pg21 sleeve	HDC-HB-24-SDVO2/21	1662180000	2
1 x Pg29 complete	HDC-HBD-64-SDVO1/29P	1662270000	2
1 x Pg29 sleeve	HDC-HBD-64-SDVO1/29	1662280000	2
2 x Pg21 complete	HDC-HBD-64-SDVO2/21P	1662250000	2

SDVO = Base housing with cover, side locking upper side

Version	Type	Cat. No.	Qty.
<b>Standard housings with cover</b>			
	HDC-HB-24-ADVO	1213300000	2

ADVO = Bulkhead housing with cover, side locking upper side

Type	Cat. No.	Qty.
<b>Plastic cover</b>		
HDC-HB-24-DBP	1665650000	2

For accessories see section "Accessories"

# Housings Group Size 8

## Plug hood HB-24

End locking / lower side



TOVL



TSVL

Dimensions

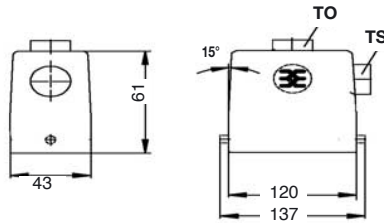

## Plug hood HBD-64

End locking / lower side / high version



TOVL



TSVL

Dimensions

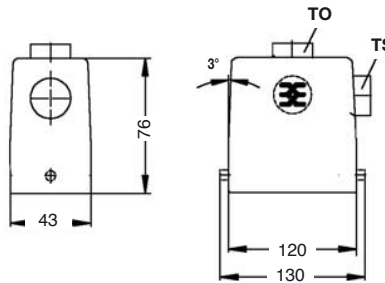

## Base housing HB-24 / HBD-64

End locking / with/without cover



SVL



SDVL

Dimensions

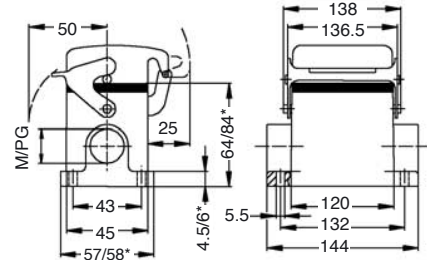

\*HB/HBD

Version	Type	Cat. No.	Qty.
<b>Standard housings, metric thread</b>			
1 x M 25 sleeve	HDC HB24 TSVL 1xM25	1787800000	2
1 x M 32 sleeve	HDC HB24 TSVL 1xM32	1787790000	2
1 x M 25 thread	HDC HB24 TOVL 1xM25G	1787860000	2
1 x M 32 thread	HDC HB24 TOVL 1xM32G	1787850000	2
<b>Standard housings, PG thread</b>			
1 x Pg21 complete	HDC-HB-24-TSVL1/21P	1213800000	2
1 x Pg21 sleeve	HDC-HB-24-TSVL1/21	1662390000	2
1 x Pg29 complete	HDC-HB-24-TSVL1/29P	1662400000	2
1 x Pg29 sleeve	HDC-HB-24-TSVL1/29	1662410000	2
1 x Pg21 complete	HDC-HB-24-TOVL1/21P	1213600000	2
1 x Pg21 sleeve	HDC-HB-24-TOVL1/21	1662540000	2
1 x Pg29 complete	HDC-HB-24-TOVL1/29P	1213700000	2
1 x Pg29 sleeve	HDC-HB-24-TOVL1/29	1662550000	2

TOVL Plug hood; Top cable entry, end locking lower side  
 TSVL = Plug hood; Side cable entry, end locking lower side

Version	Type	Cat. No.	Qty.
<b>Standard housings, metric thread</b>			
1 x M 25 thread	HDC HBD64 TSVL 1xM25G	1786820000	2
1 x M 32 thread	HDC HBD64 TSVL 1xM32G	1786810000	2
1 x M 25 thread	HDC HBD64 TOVL 1xM25G	1786870000	2
1 x M 32 thread	HDC HBD64 TOVL 1xM32G	1786860000	2
<b>Standard housings, PG thread</b>			
1 x Pg21 complete	HDC-HBD-64-TSVL1/21P	1662460000	2
1 x Pg21 sleeve	HDC-HBD-64-TSVL1/21	1662470000	2
1 x Pg29 complete	HDC-HBD-64-TSVL1/29P	1662480000	2
1 x Pg29 sleeve	HDC-HBD-64-TSVL1/29	1662490000	2
1 x Pg29 complete	HDC-HBD-64-TOVL1/29P	1662620000	2
1 x Pg29 sleeve	HDC-HBD-64-TOVL1/29	1662630000	2

TOVL Plug hood; Top cable entry, end locking lower side  
 TSVL = Plug hood; Side cable entry, end locking lower side

Version	Type	Cat. No.	Qty.
<b>Standard housings, metric thread</b>			
2 x M 25 thread	HDC HB24 SVL 2xM25G	1787880000	2
2 x M 25 thread	HDC HBD64 SVL 2xM25G	1786910000	2
2 x M 32 thread	HDC HBD64 SVL 2xM32G	1786900000	2
2 x M 25 thread	HDC HBD64 SDVL 2xM25G	1786950000	2
2 x M 32 thread	HDC HBD64 SDVL 2xM32G	1786940000	2
<b>Standard housings with cover, metric thread</b>			
2 x M 25 thread	HDC HB24 SDVL 2xM25G	1787900000	2
<b>Standard housings, PG thread</b>			
1 x Pg21 complete	HDC-HB-24-SVL1/21P	1214000000	2
1 x Pg21 sleeve	HDC-HB-24-SVL1/21	1662710000	2
2 x Pg21 complete	HDC-HB-24-SVL2/21P	1214100000	2
2 x Pg21 sleeve	HDC-HB-24-SVL2/21	1662720000	2
2 x Pg21 complete	HDC-HBD-64-SVL2/21P	1662780000	2
<b>Standard housings with cover, PG thread</b>			
1 x Pg21 complete	HDC-HB-24-SDVL1/21P	1214400000	2
1 x Pg21 sleeve	HDC-HB-24-SDVL1/21	1662920000	2
2 x Pg21 complete	HDC-HB-24-SDVL2/21P	1214500000	2
2 x Pg29 sleeve	HDC-HBD-64-SDVL2/29	1663040000	2
1 x Pg21 complete	HDC-HBD-64-SDVL1/21P	1662970000	2
1 x Pg29 complete	HDC-HBD-64-SDVL1/29P	1663010000	2

SVL = Base housing, end locking  
 SDVL = Base housing with cover, end locking

For accessories see section "Accessories"

# Housings Group Size 8

## Coupling hood HB-24 / HBD-64

End locking



KVL

## Bulkhead housing HB-24

End locking, with/without cover



AVL



ADVL

### Dimensions

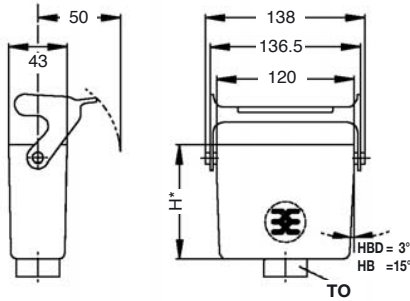

\*HB = 63.8  
HBD = 78.8

Version	Type	Cat. No.	Qty.
<b>Standard housings, metric thread</b>			
1 x M 25 thread	HDC HB24 KVL 1xM25G	1787940000	2
1 x M 32 thread	HDC HB24 KVL 1xM32G	1787930000	2
1 x M 25 thread	HDC HBD64 KVL 1xM25G	1786990000	2
1 x M 32 thread	HDC HBD64 KVL 1xM32G	1786980000	2
<b>Standard housings, PG thread</b>			
1 x Pg21 complete	HDC-HB-24-KVL1/21P	1663130000	2
1 x Pg29 complete	HDC-HB-24-KVL1/29P	1214200000	2
1 x Pg29 complete	HDC-HBD-64-KVL1/29P	1663220000	2

KVL = Coupling hood, end locking

### Dimensions

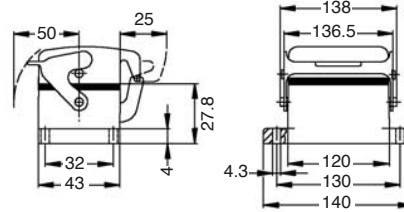

Version	Type	Cat. No.	Qty.
<b>Standard housings</b>			
	HDC-HB-24-AVL	1213900000	2
<b>Standard housings with cover</b>			
	HDC-HB-24-ADVL	1214300000	2

AVL = Bulkhead housing, end locking

ADVL = Bulkhead housing with cover, end locking

For accessories see section "Accessories"

# Housings Group Size 8

## Plug hood HBD-64

Centre locking



TSVZ

## Base housing HB-24

Centre locking upper side



SVZ

## Bulkhead housing HB-24

Centre locking



AVZ

### Dimensions

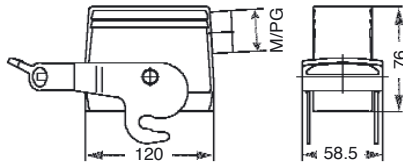

### Dimensions

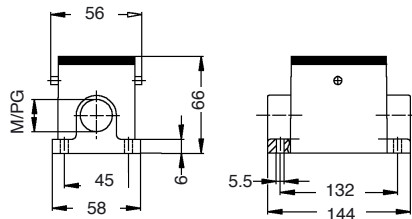

### Dimensions

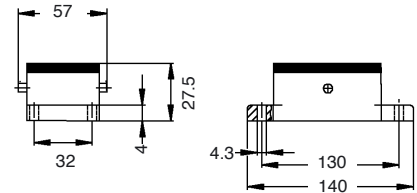

Version	Type	Cat. No.	Qty.
<b>Standard housings, metric thread</b>			
1 x Pg21	complete HDC-HBD-64-TSVZ1/21P	1663360000	2
1 x Pg29	complete HDC-HBD-64-TSVZ1/29P	1603510000	2
1 x Pg29	sleeve HDC-HBD-64-TSVZ1/29	1663390000	2

Version	Type	Cat. No.	Qty.
<b>Standard housings, PG thread</b>			
1 x Pg21	complete HDC-HB-24-SVZ1/21P	1600620000	2

Version	Type	Cat. No.	Qty.
<b>Standard housings</b>			
	HDC-HB-24-AVZ	1611350000	2

TSVZ = Plug hood; Side cable entry, centre locking

SVZ = Base housing, centre locking

AVZ = Bulkhead housing, centre locking

For accessories see section "Accessories"



# Housings Group Size 10

## Plug hood HB-32

End locking / lower side



TOVL

## Base housing HB-32

End locking with/without cover



SVL

## Coupling hood HB-32

End locking / with cover



KDVL



SDVL

### Dimensions

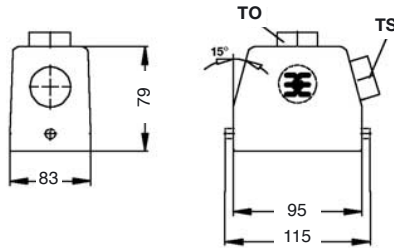

### Dimensions

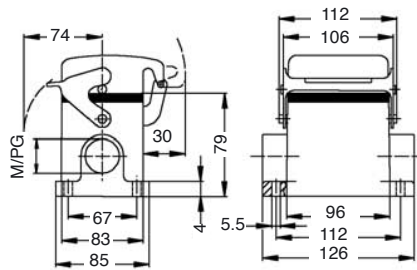

### Dimensions

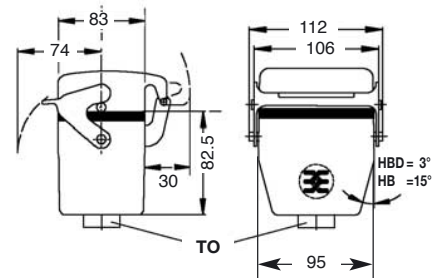

Version	Type	Cat. No.	Qty.
<b>Standard housings, metric thread</b>			
1 x M 32 thread	HDC HB32 TSVL 1xM32G	1788420000	1
1 x M 32 thread	HDC HB32 TOVL 1xM32G	1788450000	1
<b>Standard housings, PG thread</b>			
1 x Pg29 complete	HDC-HB-32-TSVL1/29P	1219300000	1
1 x Pg29 sleeve	HDC-HB-32-TSVL1/29	1667120000	1
1 x Pg29 complete	HDC-HB-32-TOVL1/29P	1219200000	1

Version	Type	Cat. No.	Qty.
<b>Standard housings, metric thread</b>			
2 x M 32 thread	HDC HB32 SVL 2xM32G	1788470000	1
<b>Standard housings with cover, metric thread</b>			
2 x M 32 thread	HDC HB32 SDVL 2xM32G	1788490000	1
<b>Standard housings, PG thread</b>			
1 x Pg29 complete	HDC-HB-32-SVL1/29P	1219600000	1
<b>Standard housings with cover, PG thread</b>			
1 x Pg29 complete	HDC-HB-32-SDVL1/29P	1219900000	1
2 x Pg29 complete	HDC-HB-32-SDVL2/29P	1220000000	1

Version	Type	Cat. No.	Qty.
<b>Standard housings with cover, metric thread</b>			
1 x M 32 thread	HDC HB32 KDVL 1xM32G	1788500000	1

TOVL = Plug hood; Top cable entry, end locking lower side

TSVL = Plug hood; Side cable entry, end locking lower side

SVL = Base housing, end locking

SDVL = Base housing with cover, end locking

KDVL = Coupling hood with cover, end locking

For accessories see section "Accessories"







# Housings Group Size 10

## Coupling hood HB-32

Side locking



## Bulkhead housing HB-32

Side locking



### Dimensions

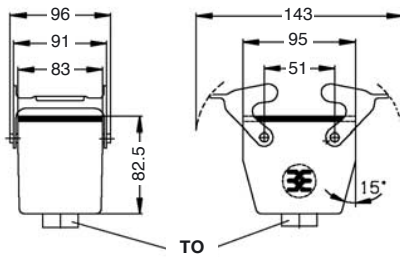

### Dimensions

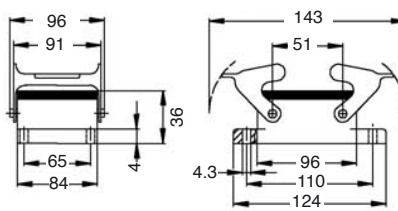

Version	Type	Cat. No.	Qty.
<b>Standard housings, PG thread</b>			
1 x Pg29	complete HDC-HB-32-KVU1/29P	1218100000	1

KVU = Coupling hood, side locking

Version	Type	Cat. No.	Qty.
<b>Standard housings</b>			
	HDC-HB-32-AVU	1217800000	1

AVU = Bulkhead housing, side locking

For accessories see section "Accessories"

# Housings Group Size 10

## Plug hood HB-32

Side locking



TOVO



TSVO

Dimensions

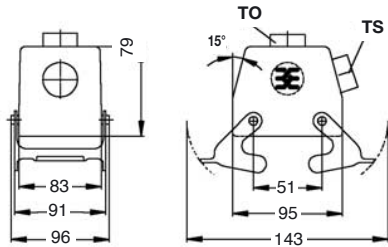

Version	Type	Cat. No.	Qty.
<b>Standard housings, metric thread</b>			
1 x M 32 thread	HDC HB32 TSVO 1xM32G	1788410000	1
1 x M 32 thread	HDC HB32 TOVO 1xM32G	1788440000	1
<b>Standard housings, PG thread</b>			
1 x Pg29 complete	HDC-HB-32-TSVO1/29P	1218500000	1
1 x Pg29 complete	HDC-HB-32-TOVO1/29P	1218300000	1

TOVO = Plug hood; Top cable entry, side locking  
 TSVO = Plug hood; Side cable entry side locking

## Base housing HB-32

Side locking upper side / with cover



SDVO

Dimensions

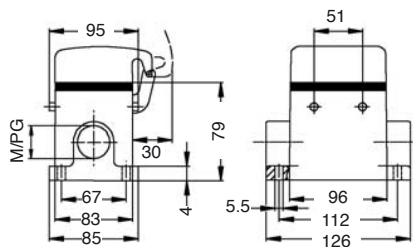

Version	Type	Cat. No.	Qty.
<b>Standard housings with cover, metric thread</b>			
2 x M 32 thread	HDC HB32 SDVO 2xM32G	1788480000	1
<b>Standard housings with cover, PG thread</b>			
1 x Pg29 complete	HDC-HB-32-SDVO1/29P	1218900000	1
2 x Pg29 complete	HDC-HB-32-SDVO2/29P	1219000000	1

SDVO = Base housing with cover, side locking upper side

## Bulkhead housing HB-32

Side locking upper side / with cover



ADVO

Dimensions

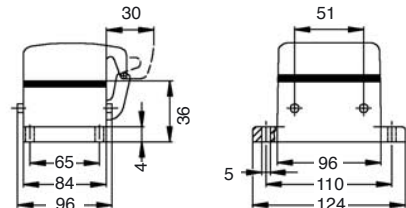

Version	Type	Cat. No.	Qty.
<b>Standard housings with cover</b>			
	HDC-HB-32-ADVO	1218800000	1

ADVO = Bulkhead housing with cover, side locking upper side

Series HD

For accessories see section "Accessories"



# Housings Group Size 12

## Plug hood HB-48

End locking / lower side



TOVL



TSVL

Dimensions

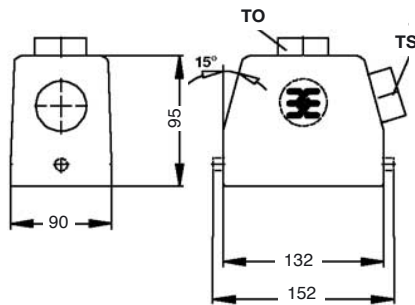

Version	Type	Cat. No.	Qty.
<b>Standard housings, metric thread</b>			
1 x M 32 thread	HDC HB48 TSVL M32G	1788320000	1
1 x M 40 thread	HDC HB48 TSVL M40G	1788310000	1
1 x M 50 thread	HDC HB48 TSVL M50G	1788300000	1
1 x M 32 thread	HDC HB48 TOVL M32G	1788350000	1
1 x M 40 thread	HDC HB48 TOVL M40G	1788340000	1
1 x M 50 thread	HDC HB48 TOVL M50G	1788330000	1
<b>Standard housings, PG thread</b>			
1 x Pg29 complete	HDC-HB-48-TSVL1/29P	1222600000	1
1 x Pg29 sleeve	HDC-HB-48-TSVL1/29	1650850000	1
1 x Pg36 complete	HDC-HB-48-TSVL1/36P	1222700000	1
1 x Pg36 sleeve	HDC-HB-48-TSVL1/36	1650860000	1
1 x Pg42 complete	HDC-HB-48-TSVL1/42P	1222800000	1
1 x Pg42 sleeve	HDC-HB-48-TSVL1/42	1670470000	1
1 x Pg29 complete	HDC-HB-48-TOVL1/29P	1222300000	1
1 x Pg29 sleeve	HDC-HB-48-TOVL1/29	1650980000	1
1 x Pg36 complete	HDC-HB-48-TOVL1/36P	1222400000	1
1 x Pg36 sleeve	HDC-HB-48-TOVL1/36	1651000000	1
1 x Pg42 complete	HDC-HB-48-TOVL1/42P	1222500000	1

TOVL = Plug hood; Top cable entry, end locking lower side

TSVL = Plug hood; Top cable entry, end locking lower side

For accessories see section "Accessories"

## Base housing HB-48

End locking / with/without cover



SVL



SDVL

Dimensions

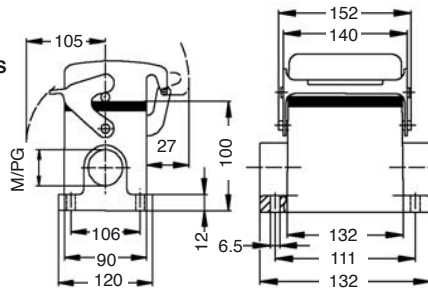

Version	Type	Cat. No.	Qty.
<b>Standard housings, metric thread</b>			
2 x M 32 thread	HDC HB48 SVL 2xM32G	1788370000	1
2 x M 40 thread	HDC HB48 SVL 2xM40G	1788360000	1
<b>Standard housings with cover, metric thread</b>			
2 x M 32 thread	HDC HB48 SDVL 2xM32G	1788390000	2
2 x M 40 thread	HDC HB48 SDVL 2xM40G	1788380000	2
<b>Standard housings, PG thread</b>			
1 x Pg29 complete	HDC-HB-48-SVL1/29P	1223000000	1
1 x Pg29 sleeve	HDC-HB-48-SVL1/29	1651100000	1
1 x Pg36 complete	HDC-HB-48-SVL1/36P	1223200000	1
2 x Pg29 complete	HDC-HB-48-SVL2/29P	1223100000	1
<b>Standard housings with cover, PG thread</b>			
1 x Pg29 complete	HDC-HB-48-SDVL1/29P	1223400000	2
1 x Pg36 complete	HDC-HB-48-SDVL1/36P	1223600000	2
2 x Pg29 complete	HDC-HB-48-SDVL2/29P	1223500000	1
2 x Pg29 sleeve	HDC-HB-48-SDVL2/29	1667560000	1
2 x Pg36 complete	HDC-HB-48-SDVL2/36P	1223700000	1

SVL = Base housing, end locking

SDVL = Base housing with cover, end locking

## Bulkhead housing HB-48

End locking / with/without cover



Dimensions

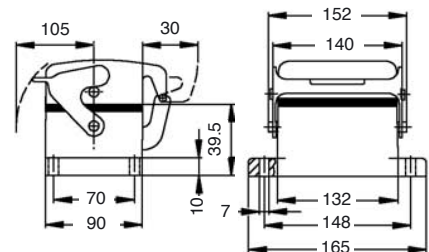

Version	Type	Cat. No.	Qty.
<b>Standard housings with cover</b>			
	HDC-HB-48-ADVL	1222900000	1

ADVL = Bulkhead housing, end locking

Series HD