

## VC-MEMV-A4

Order No.: 1884351

The illustration shows version VC-MEMV-A6



<http://eshop.phoenixcontact.de/phoenix/treeViewClick.do?UID=1884351>

Panel mounting base, made of metal, EMC-coated type 4, number of modules 5, cable screw connection Pg21

Commercial data	
EAN	4017918164386
Pack	5 pcs.
Customs tariff	79070090
Weight/Piece	0.58 KG
Catalog page information	Page 370 (PC-2009)

#### Product notes

WEEE/RoHS-compliant since:  
11/08/2006



<http://www.download.phoenixcontact.com>  
Please note that the data given here has been taken from the online catalog. For comprehensive information and data, please refer to the user documentation. The General Terms and Conditions of Use apply to Internet downloads.

## Technical data

### General characteristics

Note	When using fiber optics, the bending radii of the cable manufacturers must be observed.
Design	VC4
Degree of protection	IP65/IP66/IP67
Type of the screw connection	1x Pg21
Pg screw connection	None
Height	61 mm
Number of module slots	5
Housing material	Zinc die-cast
Housing surface material	Nickel-plated
Seal material	EPDM, conductive
Ambient temperature (operation)	-40 °C ... 125 °C

## Certificates / Approvals



Certification GOST

## Accessories

Item	Designation	Description
<b>Marking</b>		
1852875	VC-BZS WH	Marker labels, unprinted, 5-section, for individual labeling with M-PEN or CMS system, white

Diagrams/Drawings

Dimensioned drawing

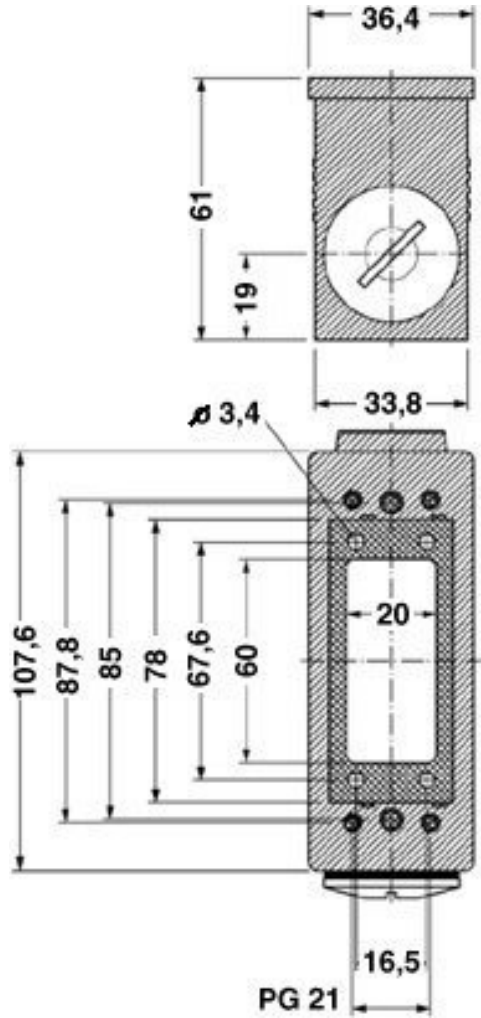

**Address**

PHOENIX CONTACT Deutschland GmbH  
Flachsmarktstr. 8  
32825 Blomberg, Germany  
Phone +49 5235 3 12000  
Fax +49 5235 3 41200  
<http://www.phoenixcontact.de>



© 2010 Phoenix Contact  
Technical modifications reserved;