

CONFIDENTIAL

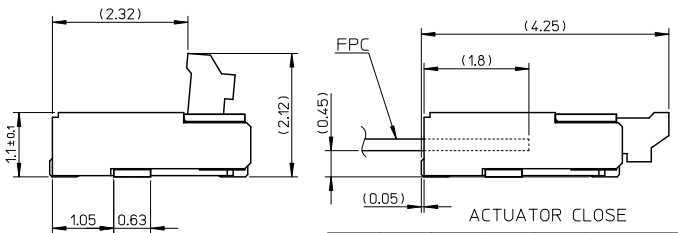
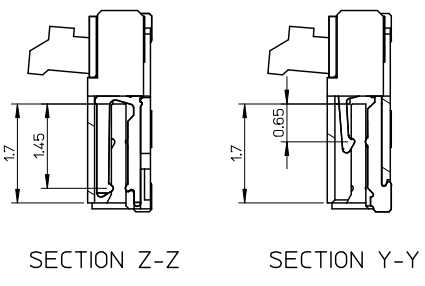
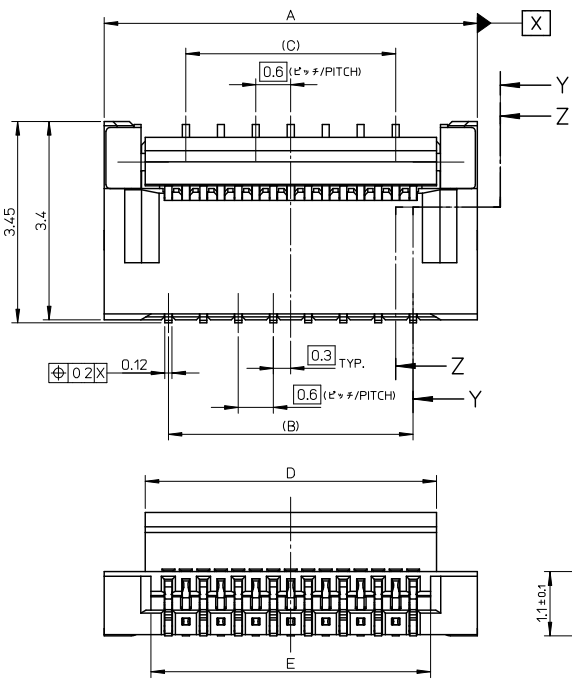

15.6	15.8	14.4	15.0	17.2	501616-5185	501616-5150	51
13.8	14.0	12.6	13.2	15.4	501616-4585	501616-4550	45
12.6	12.8	11.4	12.0	14.2	501616-4185	501616-4150	41
12.0	12.2	10.8	11.4	13.6	501616-3985	501616-3950	39
10.8	11.0	9.6	10.2	12.4	501616-3585	501616-3550	35
E	D	(C)	(B)	A	EMBOSSED TAPE ORDER No.		MATERIAL NO. CIRCUIT

- 部品構成
- ハウジング・・・材質：耐熱性樹脂 黒色 UL94V-0
HOUSING
MATERIAL :HEAT RESISTANT POLYMER BLACK UL94-V0
 - 奇数ターミナル・・・材質：銅合金
ODD TERMINAL MATERIAL :COPPER ALLOY
処理：ニッケル下地部分金メッキ（接触部及びテール部）
FINISH :PARTLY GOLD(CONTACT,TAIL) OVER NICKEL PLATING
 - 偶数ターミナル・・・材質：銅合金
EVEN TERMINAL MATERIAL :COPPER ALLOY
処理：ニッケル下地部分金メッキ（接触部及びテール部）
FINISH :PARTLY GOLD(CONTACT,TAIL) OVER NICKEL PLATING
 - アクチュエータ・・・材質：耐熱性樹脂 灰色 UL94V-0
ACTUATOR
MATERIAL :HEAT RESISTANT POLYMER GRAY UL94-V0
 - ネイル・・・材質：銅合金
NAIL MATERIAL :COPPER ALLOY
処理：ニッケル下地部分金メッキ
FINISH :TIN OVER NICKEL PLATING

REVISED EC NO: J2009-1520 DRAWN:AKAHASHI 03 2008/11/21 CHKD:THIRUYAMA 2008/11/21 APPR:NIKIITA 2008/11/21	DESCRIPTION	GENERAL TOLERANCES (UNLESS SPECIFIED)	DIMENSION STYLE MM ONLY	SCALE 15:1	DESIGN UNITS METRIC	THIRD ANGLE PROJECTION
	10 UNDER	±0.2	DRAWN BY K.SATO	DATE 2007/01/26	TITLE 0.3 FPC CONN. E/O H=1.1 HSG ASSY LONG ACTUATOR	
	10 OVER 30 UNDER	±0.25	CHECKED BY H.HIRATA	DATE 2007/01/26	MOLEX INCORPORATED	
	30 OVER	±0.3	APPROVED BY M.SASAO	DATE 2007/01/26	DOCUMENT NO. SD-501616-007	SHEET NO. 1 OF 2
B	ANGULAR ±3°	DRAFT WHERE APPLICABLE MUST REMAIN WITHIN DIMENSIONS	MATERIAL NO. SEE CHART	THIS DRAWING CONTAINS INFORMATION THAT IS PROPRIETARY TO MOLEX INCORPORATED AND SHOULD NOT BE USED WITHOUT WRITTEN PERMISSION		

CONFIDENTIAL

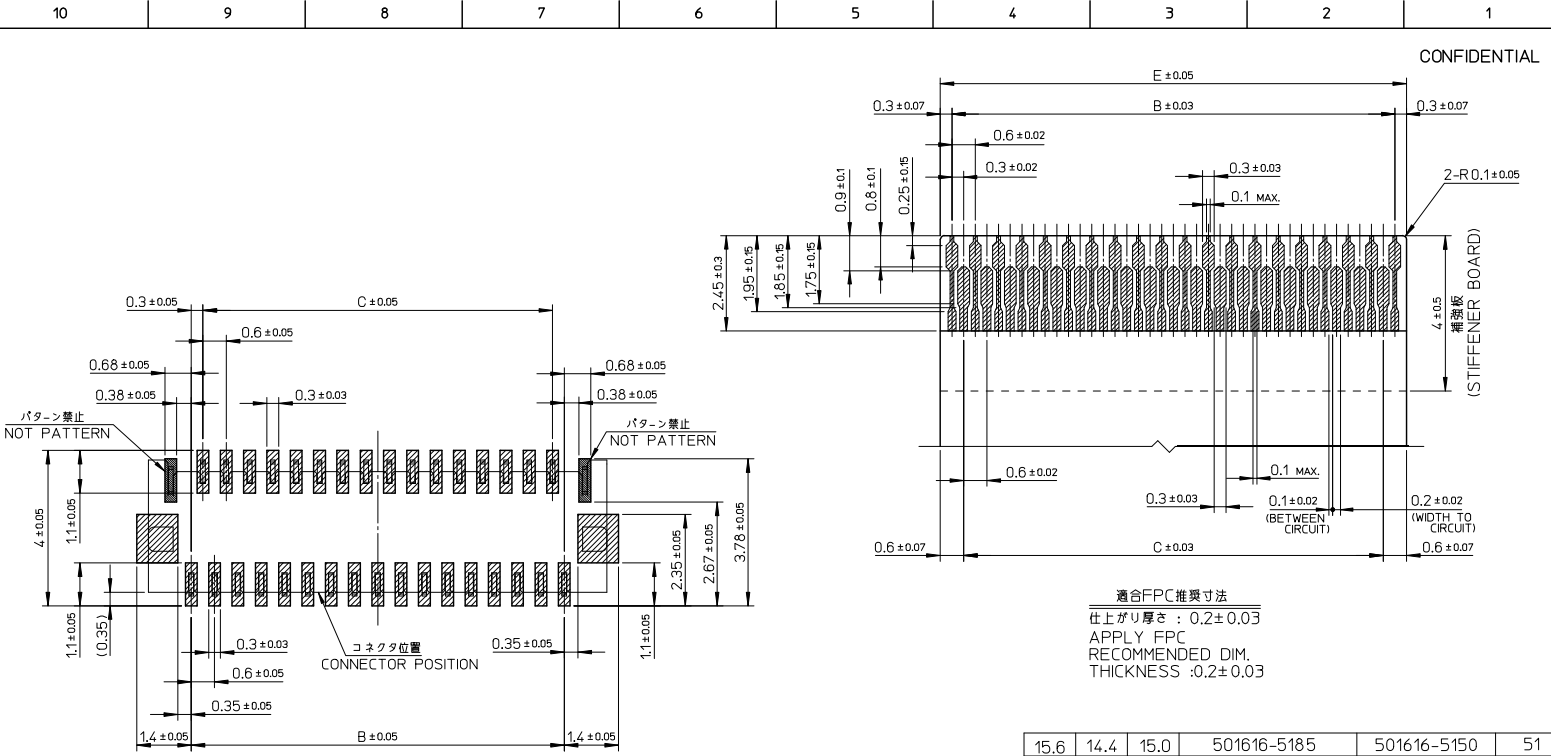

適合FPC推奨寸法
 仕上がり厚さ : 0.2±0.03
 APPLY FPC
 RECOMMENDED DIM.
 THICKNESS :0.2±0.03

15.6	14.4	15.0	501616-5185	501616-5150	51
13.8	12.6	13.2	501616-4585	501616-4550	45
12.6	11.4	12.0	501616-4185	501616-4150	41
12.0	10.8	11.4	501616-3985	501616-3950	39
10.8	9.6	10.2	501616-3585	501616-3550	35

参考基板レイアウト (マウント面)
 P.C.BOARD PATTERN
 DIM.(REF.)

- 注記
- 基板実装前にアクチュエータを操作しないで下さい。
 PLEASE DO NOT OPERATE THE ACTUATOR BEFORE MOUNTING.
 必ず基板に実装し、FPCを挿入してからアクチュエータを操作して下さい。
 PLEASE OPERATE THE ACTUATOR AFTER MOUNTING ON
 THE SUBSTRATE AND MATING FPC.
 - ELV及びRoHS適合品
 ELV AND RoHS COMPLIANT

REVISED EC NO: J2009-1320 DRAWN: TAKAHASHI 03 2008/11/24 CHKD: THARUYAMA APPR: NIKITA 2008/11/24	GENERAL TOLERANCES (UNLESS SPECIFIED)		DIMENSION STYLE MM ONLY		SCALE 10:1	DESIGN UNITS METRIC	THIRD ANGLE PROJECTION
	10 UNDER	±0.2	DRAWN BY K. SATO	DATE 2007/01/26	TITLE 0.3 FPC CONN. E/O H=1.1 HSG ASSY LONG ACTUATOR		
	10 OVER 30 UNDER	±0.25	CHECKED BY H. HIRATA	DATE 2007/01/26			
	30 OVER	±0.3	APPROVED BY M. SASAO	DATE 2007/01/26	MOLEX INCORPORATED DOCUMENT NO. SD-501616-007		
ANGULAR ±3 °		MATERIAL NO. SEE CHART		SHEET NO. 2 OF 2			
DRAFT WHERE APPLICABLE MUST REMAIN WITHIN DIMENSIONS		THIS DRAWING CONTAINS INFORMATION THAT IS PROPRIETARY TO MOLEX INCORPORATED AND SHOULD NOT BE USED WITHOUT WRITTEN PERMISSION					

10 9 8 7 6 5 4 3 2 1

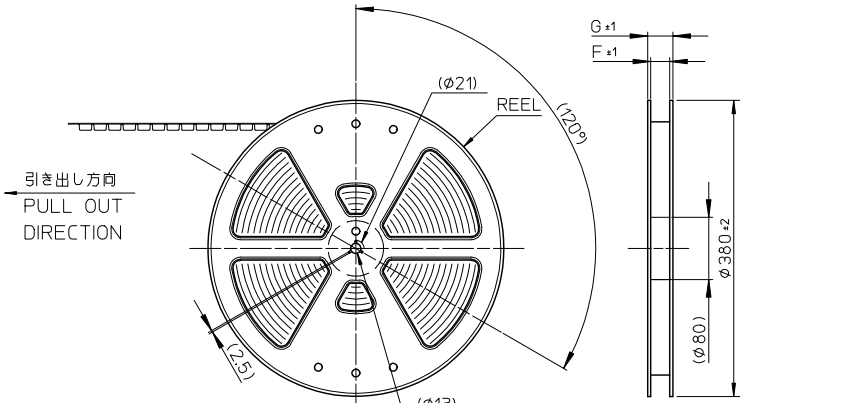

NOTES

- 製品 (501616-**50) の詳細寸法については、図面 SD-501616-007 をご参照下さい。
IN THE PACKAGE, PART NO. 501616-**50 DETAILED DIMENSIONS, REFER TO SALES DRAWING NO. SD-501616-007.
- 梱包数量 : 3000個/リール
NUMBER OF CONNECTORS : 3000 PCS/REEL
- リードテープ長さ
LEAD TAPE LENGTH

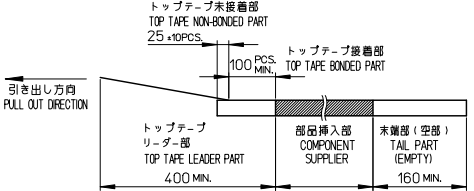

- 材料
キャリアテープ: ポリスチレン (PS)
トップテープ: PET, PE, PEF
リール: ポリスチレン (PS) <リサイクル材を含む>
MATERIAL
CARRIER TAPE: POLYSTYRENE (PS)
TOP TAPE: PET, PE, PEF
REEL: POLYSTYRENE (PS) <RECYCLE MATERIAL CONTAINED>
- ELV及びRoHS適合品
ELV AND RoHS COMPLIANT

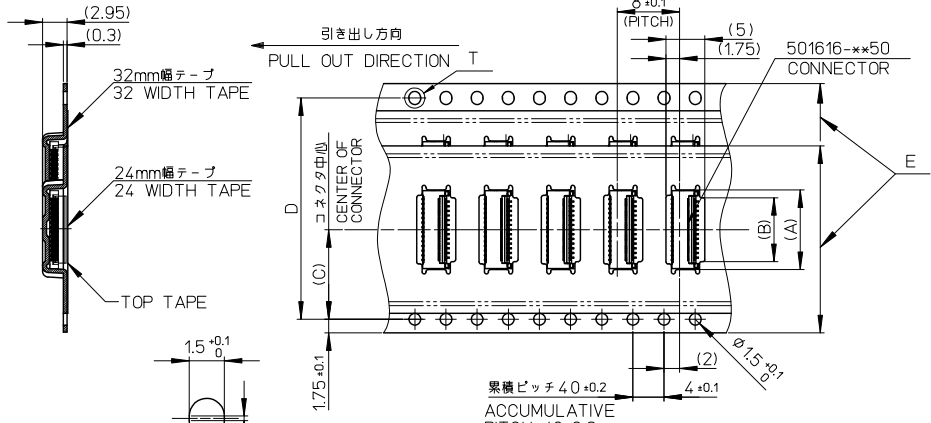

37.4	33.4	32±0.3	28.4	14.2	15.4	17.4	501616-5185	51
					13.6	15.6	501616-4585	45
29.4	25.4	24±0.3	11.5	12.4	14.4	501616-4185	41	
				11.8	13.8	501616-3985	39	
				10.6	12.6	501616-3585	35	
G	F	E キャリアテープ幅 EMBOSSED TAPE WIDTH		D	C	B	A	EMBOSSED PACKAGE オーダー番号 ORDER No. 極数

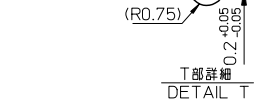

エンボステープ内の製品の向き
DIRECTION OF CONNECTOR IN
EMBOSSED TAPE

REVISED EC NO: J2009-1784 DRAWN BY: DRWNKAWABATA 2009/01/26 CHECKED BY: CHYKOSHINOYAMA 2009/01/26 APPROVED BY: APPRHSINOYAMA 2009/01/26	GENERAL TOLERANCES (UNLESS SPECIFIED)		DIMENSION STYLE MM ONLY		SCALE	DESIGN UNITS	THIRD ANGLE PROJECTION
	10 UNDER	±---	DRAWN BY	DATE	---	METRIC	
	10 OVER 30 UNDER	±---	K. SATO	2007/05/14	TITLE	0.3 FPC CONN. H=1.1 EMBSTP PKG (LONG-ACT)	
	30 OVER	±---	CHECKED BY	DATE	H. HIRATA	2007/05/14	
	ANGULAR	±--- °	APPROVED BY	DATE	M. SASAO	2007/05/14	MOLEX INCORPORATED
	DRAFT WHERE APPLICABLE MUST REMAIN WITHIN DIMENSIONS		MATERIAL NO.	DOCUMENT NO.	SEE CHART		SD-501616-008
			SIZE	THIS DRAWING CONTAINS INFORMATION THAT IS PROPRIETARY TO MOLEX INCORPORATED AND SHOULD NOT BE USED WITHOUT WRITTEN PERMISSION			