

1 2 3 4 5

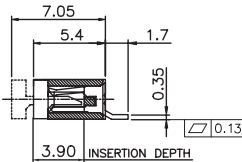

SECT. A-A

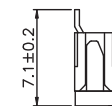
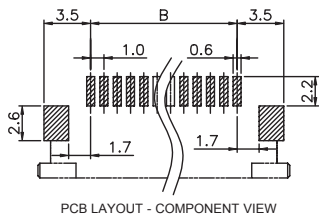
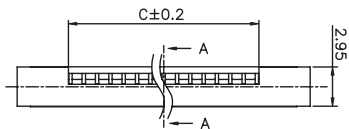
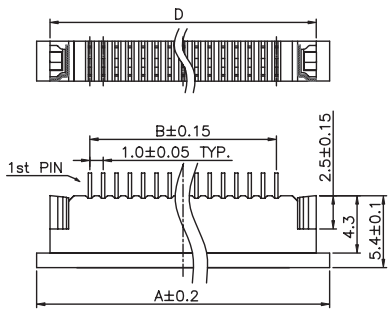
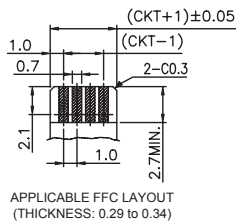

MATERIAL:
 HOUSING MATERIAL: PPS
 COLOR: BEIGE
 ACTUATOR MATERIAL: PPS
 COLOR: BROWN
 CONTACT MATERIAL: PHOSPOR BRONZE
 CONTACT PLATING: 100µ TIN OVER 50µ NI
 QUALITY CLASS: 25 MATING CYCLES

ENVIRONMENTAL:
 OPERATING TEMPERATURE: -25°C UP TO 85°C
 FLAMABILITY RATING: UL94-V0
 COMPLIANCE: LEAD FREE AND ROHS

ELECTRICAL:
 CURRENT RATING: 1A
 WORKING VOLTAGE: 125V
 INSULATION RESISTANCE: >100MOHM
 DIELECTRIC WITHSTANDING VOLT.: 500VAC/MN
 CONTACT RESISTANCE: 20mOHM MAX

STANDARD
 CERTIFIED: E323964 / MODEL NUMBER 686
 FOLLOWED BY 1, FOLLOWED BY 03 THRU 30, FOLLOWED
 BY 141 OR 144, FOLLOWED BY NUMERIC DIGITS

SOLDERING:
 REFLOW PROCESS ONLY

DIMENSION:
 A = B + 8.00
 B = 1.00 x (NB PINS - 1)
 C = B + 2.15
 D = B + 6.00

RoHS Compliant

H	13-DEC-10	COPLANARITY	GG
REV	DATE	FILE	BY

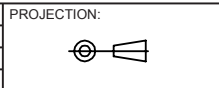

GENERAL TOLERANCE
 .X = \pm 0.2
 .XX = \pm 0.15



APPROVAL: RJ

UNIT: MM
 SCALE:
 SHEET: 1/2
 DRAW: PEARL

DESCRIPTION: 1.0MM ZIF FPC HORIZONTAL TOP CONTACT TYPE - TAPE & REEL PACKAGING
 WERI PART NO: 6861 xx 14122

SIZE
A4

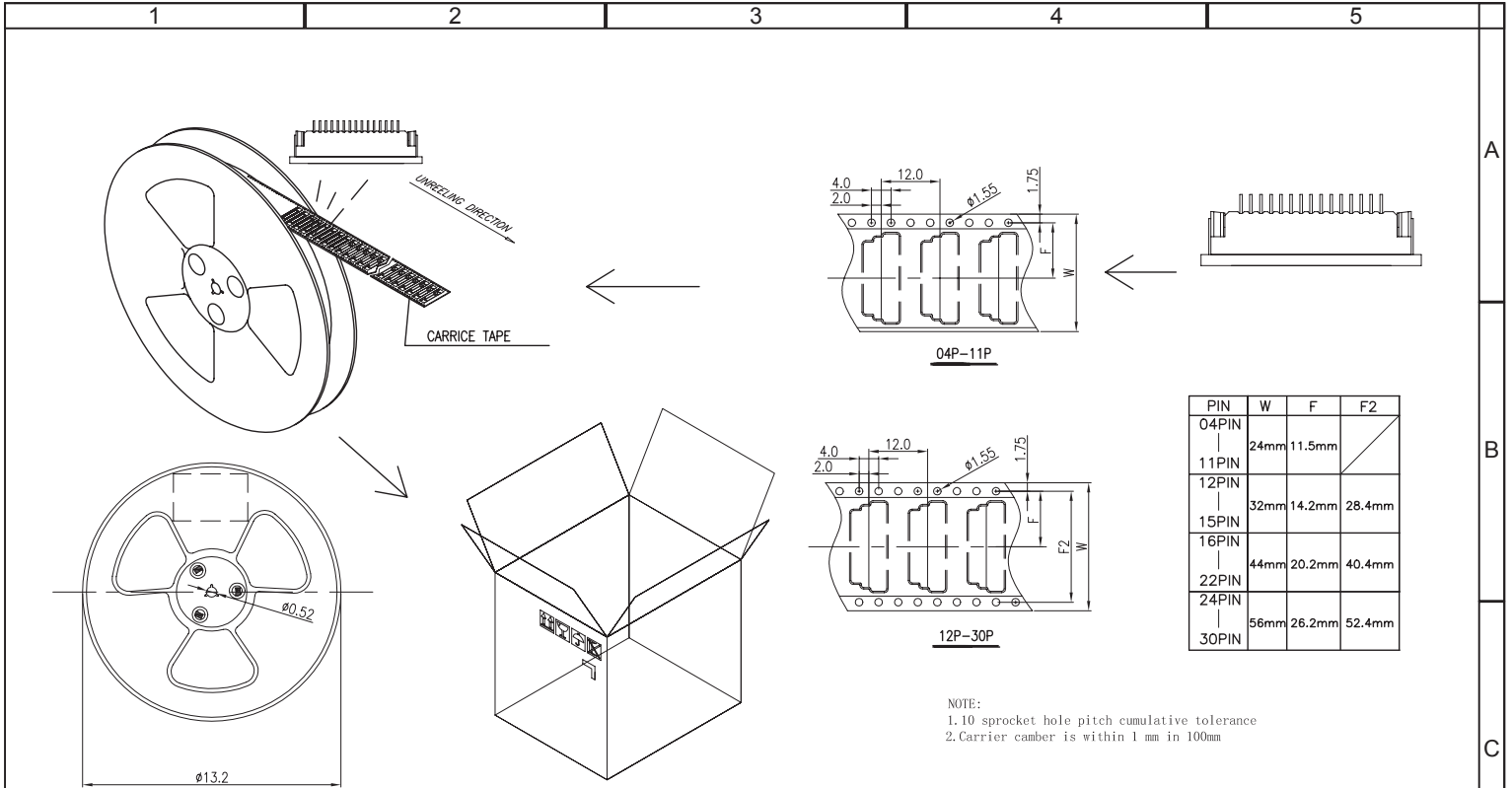

NOTE:
 1. 10 sprocket hole pitch cumulative tolerance
 2. Carrier camber is within 1 mm in 100mm

RoHS Compliant				PROJECTION: 	GENERAL TOLERANCE .X = +/- 0.2 .XX = +/- 0.15		DESCRIPTION: 1.0MM ZIF FPC HORIZONTAL BOTTOM CONTACT TYPE - TAPE & REEL PACKAGING	SIZE A4
G								
F								
E								
D								
C								
B								
A								
REV	DATE	FILE	BY	APPROVAL: RJ	UNIT: MM	WÜRTH ELEKTRONIK	WERI PART NO: 6861 xx 14122	
					SCALE:			
					SHEET: 2/2			
					DRAW: PEARL			