

DESCRIPTION: COAXIAL / SIGNAL - SOLDER CUP - FEMALE

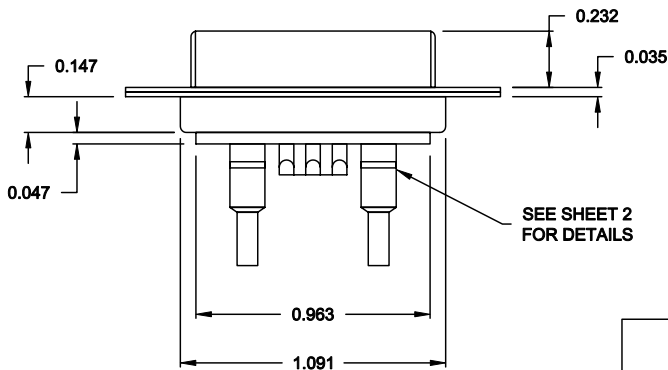
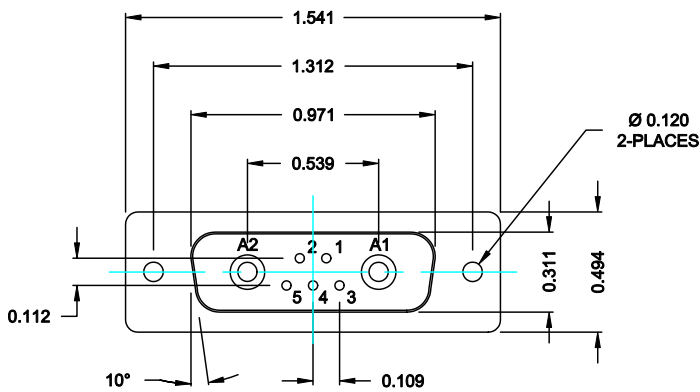

SPECIFICATIONS:

ELECTRICAL:

INSULATOR RESISTANCE: 5,000 MegOHMS Min.
 DIELECTRIC WITHSTANDING: 1,000VAC r.m.s.
 OPERATING TEMPERATURE: -55° C ~ +125° C
 CONTACT RESISTANCE: 30 Milliohms Max.
 COAXIAL PINS: 75 OHM
 SIGNAL PINS: 3 AMPS

MECHANICAL:

CONTACT INSERTION FORCE: 4.5 Kg Max.
 CONTACT SEPARATOR FORCE: 0.3Kg Min.

MATERIALS:

CONTACTS: BRASS
 INSULATOR: PBT UL94V-0 RATED, 230°C PROCESS TEMP.
 SHELL: STEEL
 FINISH: NICKEL
 SHELL: NICKEL

6827W2203L001

00 = 75 OHM COAXIAL

RoHS COMPLIANT

 NorComp	THESE DRAWINGS AND SPECIFICATIONS ARE THE PROPERTY OF NorComp AND SHALL NOT BE REPRODUCED, COPIED OR USED AS THE BASIS FOR THE MANUFACTURE OF SALE OF APPARATUS WITHOUT WRITTEN PERMISSION.		DRAWN: C. SMITH	DATE: 09-21-06
	CHECKED: X		DATE: X	
	SCALE: N.T.S.	SHEET 1	OF 2	REV 1
DWG NO.			6827W2203L001	

DESCRIPTION: 682 SERIES CONTACTS

NOTE:
SIGNAL CONTACTS COME PRE-LOADED INTO INSULATORS.
COAXIAL CONTACTS SUPPLIED - NOT PRE-LOADED.

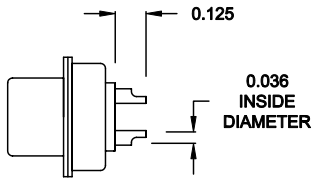

SIGNAL CONTACTS
ACCEPTS UP TO 20 AWG WIRE

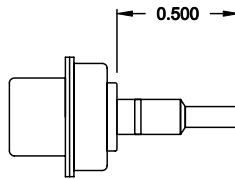

COAXIAL CONTACT
ACCEPTS 75 OHM COAX, RG179/U

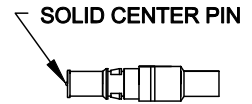

FEMALE COAXIAL CONTACT

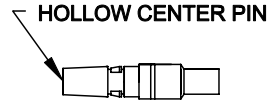

MALE COAXIAL CONTACT

RoHS COMPLIANT

	THESE DRAWINGS AND SPECIFICATIONS ARE THE PROPERTY OF NorComp AND SHALL NOT BE REPRODUCED, COPIED OR USED AS THE BASIS FOR THE MANUFACTURE OF SALE OF APPARATUS WITHOUT WRITTEN PERMISSION.		DRAWN: C. SMITH	DATE: 09-21-06
			CHECKED: X	DATE: X
<h1>NorComp</h1>		SCALE: N.T.S.	SHEET 2 OF 2	REV 1
		DWG NO. 6827W2203L001		