

Toggle Switches, AE Series, Process Sealed, Part Number Matrix

"AE" SERIES DESIGN FEATURES

- MIL-STD-202 Method 112C Leak Test
- Toggle – Machined brass, heavy nickel plated.
- Bushing & Cover - Nylon, ultrasonically welded to case, with integral "O-ring", UL94VO.
- Fixed Contact – Welded construction.
- Terminal Seal – Epoxy sealing of terminals is standard.
- Termination – Precious metal (gold or silver)/brass or copper strip with welded contact area.

MATERIAL SPECIFICATIONS:

Process Sealing "O-ring" seals will withstand wave soldering and various subsequent cleaning operations. Meets MIL-STD-202, Method 112C, Test Condition A & D, 85°C.

ENVIRONMENTAL SPECIFICATIONS

Operating Temperature.....-4°F to + 185°F (-20°C to + 85°C)
 Storage Temperature.....-49°F to + 212°F (-45°C to + 100°C)
 Solder Heat ResistanceSee page M3-4

TYPICAL PERFORMANCE CHARACTERISTICS:

Contact RatingSilver: 2 A @ 250 VAC or 5 A @ 125 VAC
 Silver: 2 A @ 30 VDC
 Gold: 0.4 VA @ 20 VAC/DC
 Contact Resistance30 Milliohms max. initial
 Insulation Resistance1,000 Megohms min. @ 500 VDC.
 Dielectric Strength1,000 Volts RMS @ sea level initial
 Static Withstanding.....15 KV per IEC 801-2
 Electrical LifeUp to 30,000 Cycles

"O-RING" DESIGN

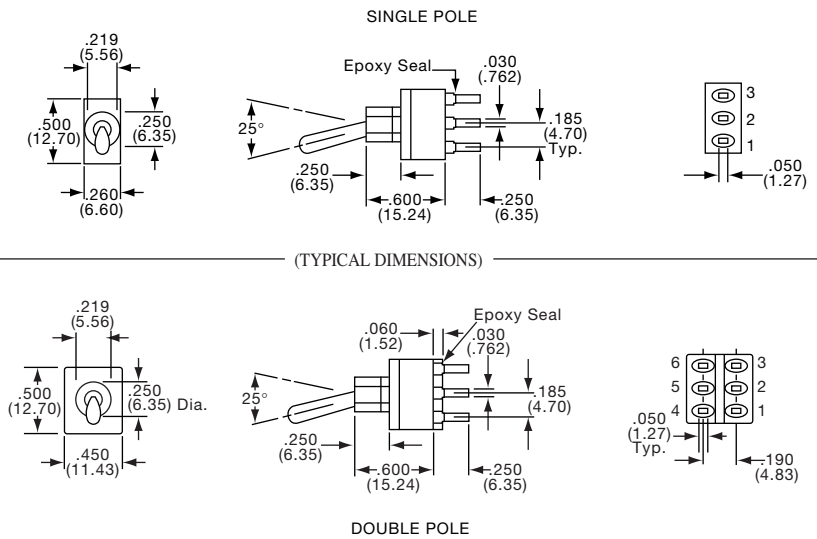
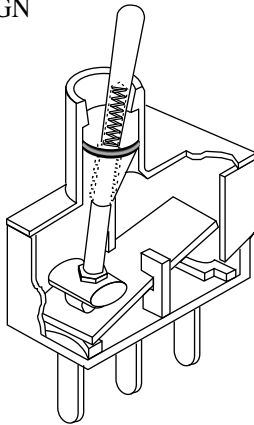

PART NUMBERING

| Model | Function | Toggle | Bushing | Terminal | Contact | Option |
|-------------------------|---------------------|-----------------------|----------------------|-------------------------------------|---------------------------|----------------------------|
| AE1 Single Pole | S Bat. Long | | D1 Unthreaded | A Right Angle | B Gold | U.L. (Q or G contact only) |
| AE2 Double Pole | L Lever | | | AV2 Vertical Right Angle | Q Silver | |
| | L1 Lever | | | C Printed Circuit | G Gold over Silver | |
| | L2 Lever | | | V30 Vertical Support Bracket | | |
| 01 On-On | M Bat. Short | | | W Wire Wrap | | |
| 03 On-Off-On | | | | Z3 Quick Connect | | |
| 05 (On)-Off-(On) | | | | Z Wire Lug | | |
| 07 On-Off-(On) | | | | | | |
| 08 On-(On) | | | | | | |
| 11 On-On-On | | | | | | |
| 13 On-On-(On) | | | | | | |
| 15 (On)-On-(On) | | | | | | |
| | | Double Pole case only | | | | |

Application Note: For surface mount termination, use the "TST" series, Page C5

Other Options
N Black finish toggle, add "N" to end of part number, but before U.L. option.

See page C36 for SP3T wiring diagram.

Toggle Switches, AE Series, Process Sealed, Options

FUNCTIONS

The following functions available in SP or DP.

- 01** 2 Positions None indicates no mechanical position
 - 03** 3 Positions Off indicates a mechanical position with no electrical connection.
 - 05** 3 Positions (On) indicates momentary action.
 - 07** 3 Positions
 - 08** 2 Positions
- SPDT, connected terminals:
- DPDT, connected terminals:

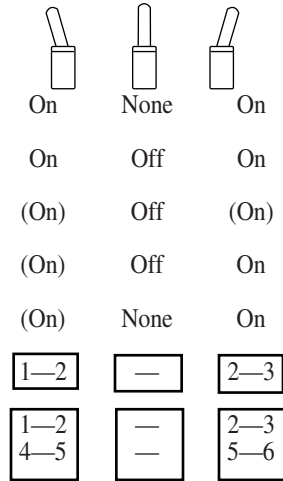

Functions available in DP case only:

- 11** 3 Positions On On On
 - 13** 3 Positions (On) On On
 - 15** 3 Positions (On) On (On)
- DP3T Connect terminals:
- * SP3T Functions achieved with external jumper installed by customer

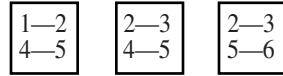

WIRING DIAGRAM FOR FUNCTIONS

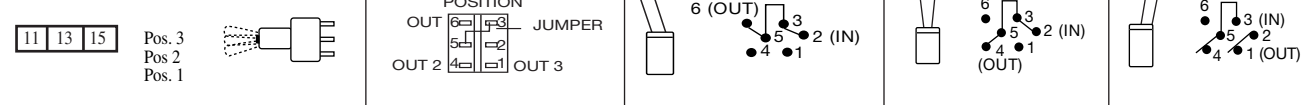

TOGGLES

S Standard

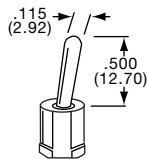

M

Short

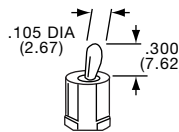

L

Lever

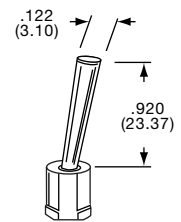

L1

Lever

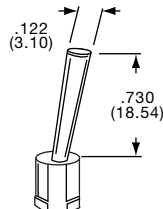

L2

Lever

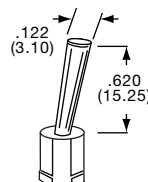

Bushing

D1

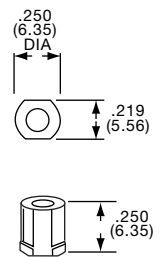

Toggle Switches, AE Series, Process Sealed, Options

TERMINALS

Z

Wire Lug

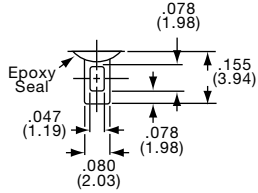

Z3

Quick Connect

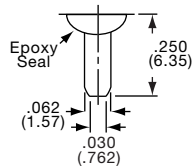

Mates with Tyco
61454 or 60900.

W

Wire Wrap

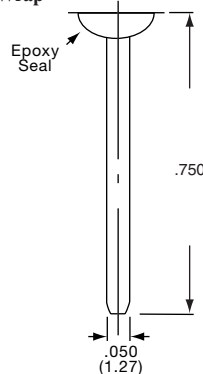

C

Printed Circuit
PC Hole Pattern

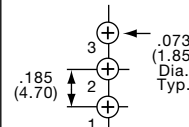
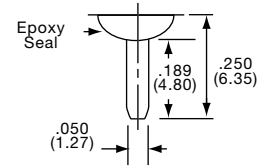

Single Pole

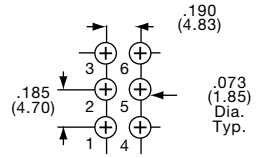

Double Pole

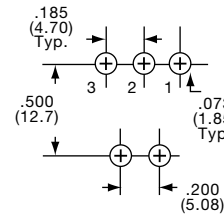
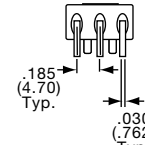
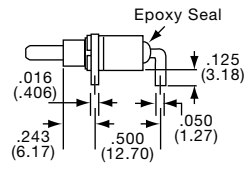
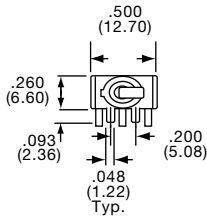

A

Right Angle
Single Pole

Note: Terminal numbers viewed from top of P.C. board

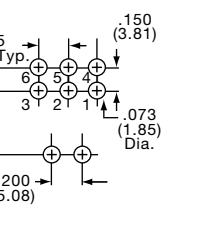
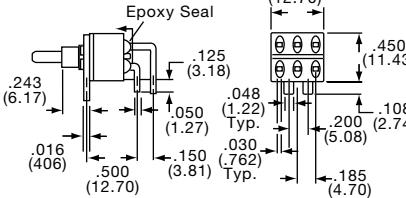

A

Right Angle
Double Pole

Note: Terminal numbers viewed from top of P.C. board

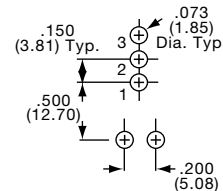
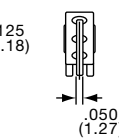
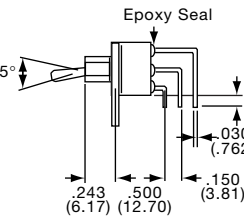
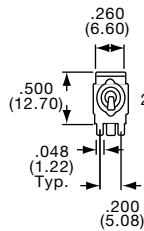

AV2

Vertical Right Angle
Single Pole

Note: Terminal numbers viewed from top of P.C. board

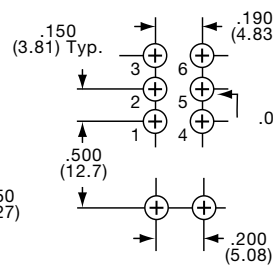
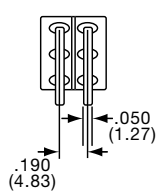
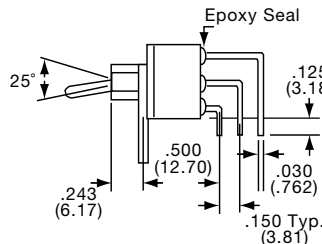
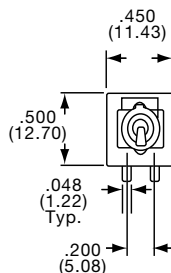

AV2

Vertical Right Angle
Double Pole

Note: Terminal numbers viewed from top of P.C. board

Toggle Switches, AE Series, Process Sealed, Options

V30

Vertical Support Bracket
Single Pole

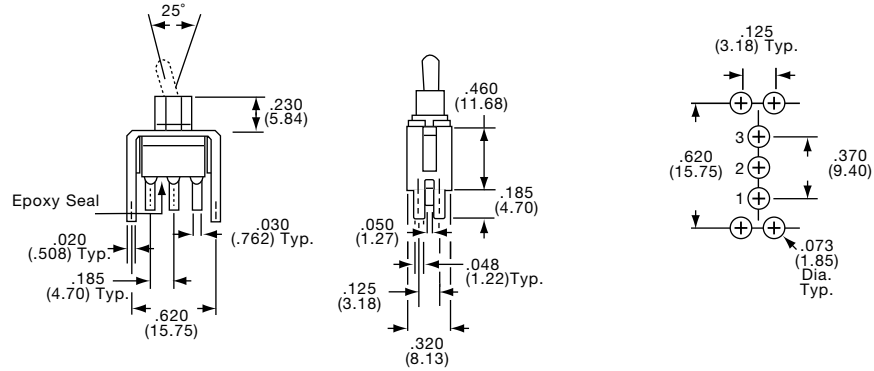

V30

Vertical Support Bracket
Double Pole

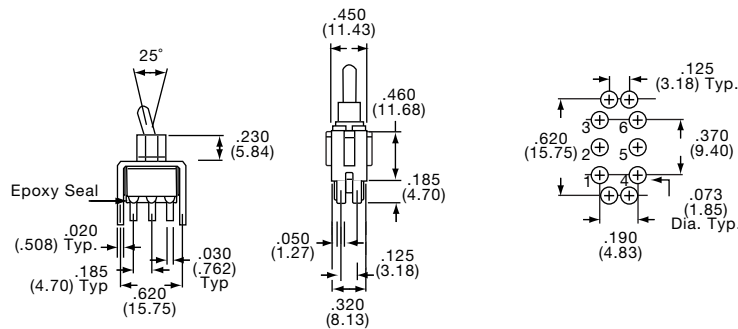

CONTACTS

B CONTACTS: Copper alloy with gold plate, welded button.

TERMINALS: Copper alloy with gold plate.

ELECTRICAL RATING: 0.4 VA @ 20 VAC/DC.

Q CONTACTS: Copper alloy with silver, welded button.

TERMINALS: Copper with silver/lead plate.

ELECTRICAL RATING: 5 A @ 125 VAC, 2 amps @ 250 VAC, 2 A @ 30 VDC.

UL/CSA RATING: 5A @ 125 VAC, 3 @ 250 VAC.
(Specify "UL" option code)

G CONTACTS: Copper alloy with gold plate over silver, welded button.

TERMINALS: Copper alloy, with gold plate.

ELECTRICAL RATING: 0.4 VA @ 20 VAC/DC or 5 A @ 125 VAC, 2 A @ 250 VAC, 2 A @ 30 VDC.

Note: This contact option can be used for low-level or power switching. If level is above 0.4 VA @ 20 VAC/DC, the switch is rendered usable only for power switching due to arc-removal of gold plate.

UL/CSA RATING: 5A @ 125 VAC, 3A @ 250 VAC
(Specify "UL" option code)

Toggle Switches, AE Series, Process Sealed, Vertical, Long Bat Actuator

* Refer to Pages C35-C38 for Additional Options *

SEE PAGE C35 FOR PRODUCT SPECIFICATIONS

SPDT



AE101SD1CQ

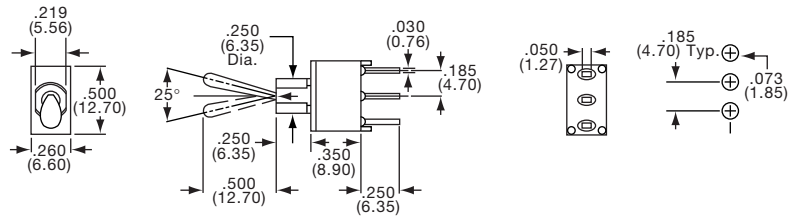

| Tyco Electronics | Alcoswitch | Tyco Electronics | Alcoswitch | Type | Act. Code | P. M5 | | | |
|------------------------|------------|----------------------|------------|------|-----------|-------|------|------|------|
| Silver Contacts | | Gold Contacts | | | | | | | |
| 2-1437556-8 | AE101SD1CQ | 2-1437556-7 | AE101SD1CB | SPDT | 1 | | On | None | On |
| 3-1437556-8 | AE103SD1CQ | 3-1437556-7 | AE103SD1CB | SPDT | 5 | | On | Off | On |
| | AE105SD1CQ | 4-1437556-6 | AE105SD1CB | SPDT | 5 | | (On) | Off | (On) |
| | AE107SD1CQ | 5-1437556-3 | AE107SD1CB | SPDT | 5 | | On | Off | (On) |
| 6-1437556-1 | AE108SD1CQ | AE108SD1CB | SPDT | 1 | | | On | None | (On) |

DPDT



AE201SD1CQ

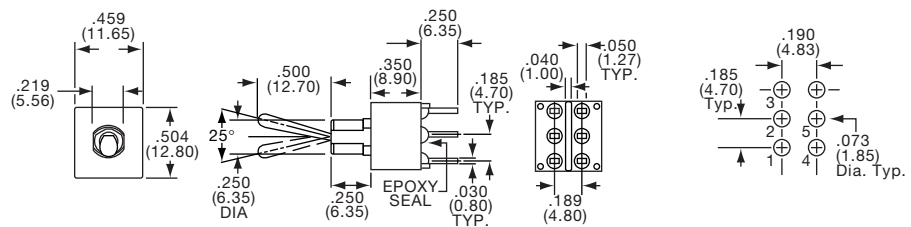

| Tyco Electronics | Alcoswitch | Tyco Electronics | Alcoswitch | Type | Act. Code | P. M5 | | | |
|------------------------|------------|----------------------|------------|------|-----------|-------|------|------|------|
| Silver Contacts | | Gold Contacts | | | | | | | |
| 7-1437556-5 | AE201SD1CQ | 7-1437556-4 | AE201SD1CB | DPDT | 2 | | On | None | On |
| | AE203SD1CQ | 8-1437556-2 | AE203SD1CB | DPDT | 6 | | On | Off | On |
| 8-1437556-5 | AE205SD1CQ | AE205SD1CB | DPDT | 6 | | | (On) | Off | (On) |
| | AE207SD1CQ | AE207SD1CB | DPDT | 6 | | | On | Off | (On) |
| | AE208SD1CQ | AE208SD1CB | DPDT | 2 | | | On | None | (On) |
| | AE211SD1CQ | AE211SD1CB | DPDT | 11 | | | On | On | On |
| | AE215SD1CQ | AE215SD1CB | DPDT | 11 | | | (On) | On | (On) |

C
Gemini Series

Toggle Switches, AE Series, Process Sealed, Right Angle, Short Bat Actuator

* Refer to Pages C35-C38 for Additional Options *

SEE PAGE C35 FOR PRODUCT SPECIFICATIONS

SPDT

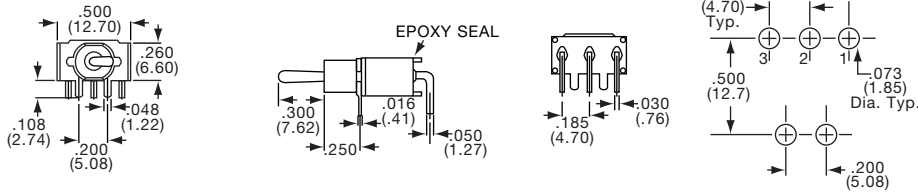

AE101MD1AQ
Horizontal Actuation

| Tyco Electronics | Alcoswitch | Tyco Electronics | Alcoswitch | Type | Act. Code | P. M5 | | | |
|------------------------|------------|----------------------|------------|------|-----------|-------|----|------|------|
| Silver Contacts | | Gold Contacts | | | | | | | |
| 1-1437556-1 | AE101MD1AQ | 1437556-8 | AE101MD1AB | SPDT | 1 | | On | None | On |
| | AE103MD1AQ | 3-1437556-1 | AE103MD1AB | SPDT | 5 | | On | Off | On |
| 5-1437556-7 | AE108MD1AQ | | AE108MD1AB | SPDT | 1 | | On | None | (On) |

DPDT

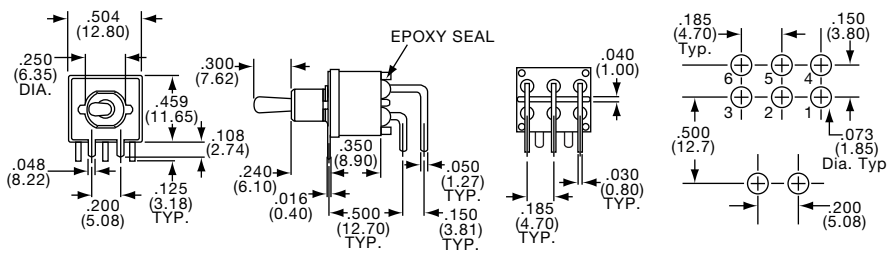

AE201MD1AQ
Horizontal Actuation

| Tyco Electronics | Alcoswitch | Tyco Electronics | Alcoswitch | Type | Act. Code | P. M5 | | | |
|------------------------|------------|----------------------|------------|------|-----------|-------|----|------|------|
| Silver Contacts | | Gold Contacts | | | | | | | |
| 6-1437556-6 | AE201MD1AQ | 6-1437556-5 | AE201MD1AB | DPDT | 2 | | On | None | On |
| 3-1437592-1 | AE203MD1AQ | 7-1437556-7 | AE203MD1AB | DPDT | 6 | | On | Off | On |
| | AE208MD1AQ | | AE208MD1AB | DPDT | 2 | | On | None | (On) |

SPDT

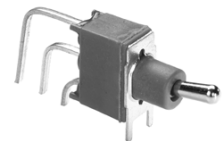
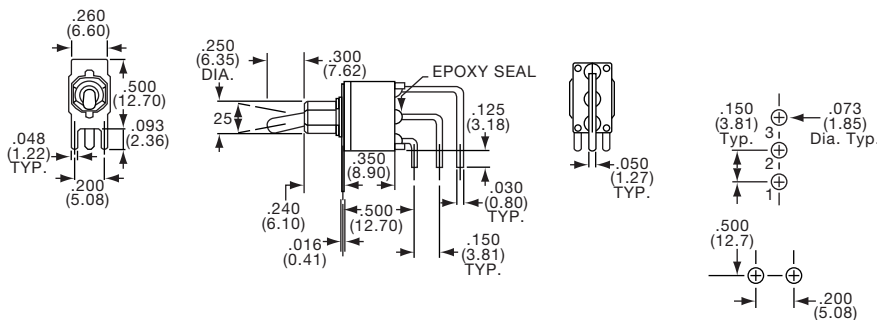

AE101MD1AV2Q
Vertical Actuation

| Tyco Electronics | Alcoswitch | Tyco Electronics | Alcoswitch | Type | Act. Code | P. M5 | | | |
|------------------------|--------------|----------------------|--------------|------|-----------|-------|----|------|------|
| Silver Contacts | | Gold Contacts | | | | | | | |
| 1-1437556-3 | AE101MD1AV2Q | 1-1437556-2 | AE101MD1AV2B | SPDT | 1 | | On | None | On |
| | AE103MD1AV2Q | 3-1437556-2 | AE103MD1AV2B | SPDT | 5 | | On | Off | On |
| 1447331-4 | AE108MD1AV2Q | 5-1437556-8 | AE108MD1AV2B | SPDT | 1 | | On | None | (On) |

Toggle Switches, AE Series, Process Sealed, Short Bat Actuator

* Refer to Pages C35-C38 for Additional Options *

SEE PAGE C35 FOR PRODUCT SPECIFICATIONS

DPDT

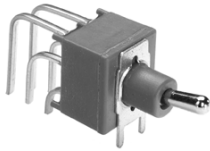

AE201MD1AV2Q

Vertical Actuation

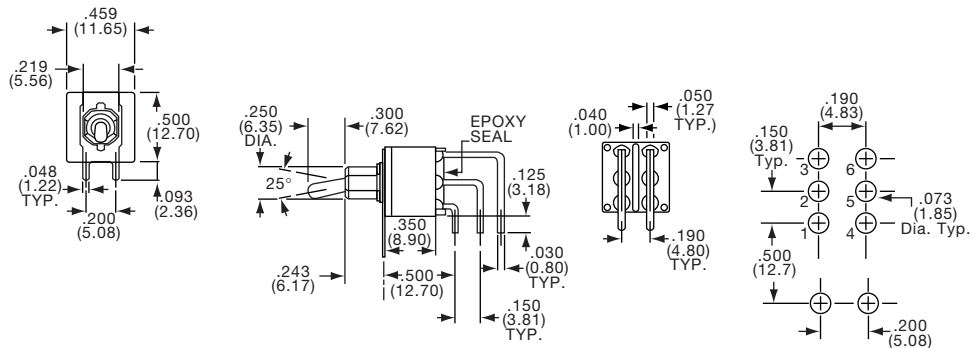

| Tyco Electronics | Alcoswitch | Tyco Electronics | Alcoswitch | Type | Act. Code | P. M5 | | | |
|-------------------------------------|--------------|-------------------------------------|--------------|------|-----------|-------|----|------|------|
| Silver Contacts 1571537-1 | AE201MD1AV2Q | Gold Contacts 6-1437556-7 | AE201MD1AV2B | DPDT | 2 | | On | None | On |
| | AE203MD1AV2Q | 7-1437556-8 | AE203MD1AV2B | DPDT | 6 | | On | Off | On |
| | AE208MD1AV2Q | | AE208MD1AV2B | DPDT | 2 | | On | None | (On) |

SPDT



AE101MD1CQ

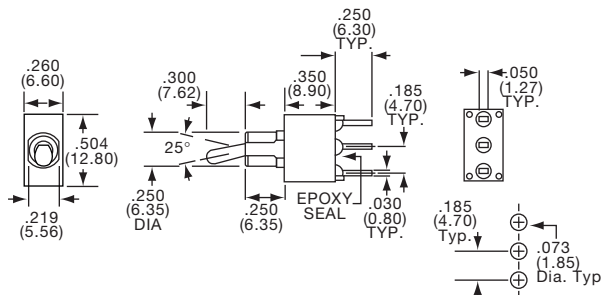

| Tyco Electronics | Alcoswitch | Type | Act. Code | P.M5 | | | |
|---------------------------------------|------------|------|-----------|------|------|------|------|
| Silver Contacts 1-1437556-7 | AE101MD1CQ | SPDT | 1 | | On | None | On |
| | AE103MD1CQ | SPDT | 5 | | On | Off | On |
| | AE105MD1CQ | SPDT | 5 | | (On) | Off | (On) |
| | AE107MD1CQ | SPDT | 5 | | On | Off | (On) |
| | AE108MD1CQ | SPDT | 1 | | On | None | (On) |
| Gold Contacts 1-1437556-5 | AE101MD1CB | SPDT | 1 | | On | None | On |
| 3-1437556-3 | AE103MD1CB | SPDT | 5 | | On | Off | On |
| | AE105MD1CB | SPDT | 5 | | (On) | Off | (On) |
| | AE107MD1CB | SPDT | 5 | | On | Off | (On) |
| | AE108MD1CB | SPDT | 1 | | On | None | (On) |

DPDT



AE201MD1CQ

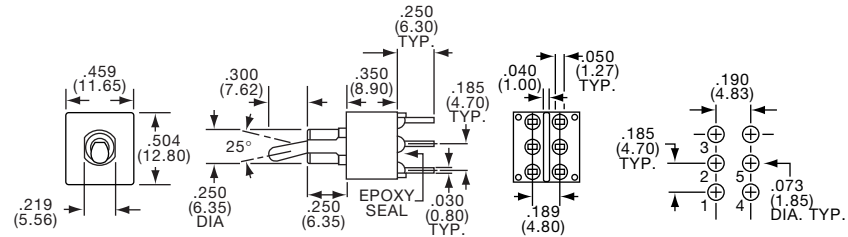

| Tyco Electronics | Alcoswitch | Type | Act. Code | P.M5 | | | | Tyco Electronics | Alcoswitch | Type | Act. Code | P.M5 | | | |
|---------------------------------------|------------|------|-----------|------|------|------|------|-------------------------------------|------------|------|-----------|------|------|------|------|
| Silver Contacts 6-1437556-9 | AE201MD1CQ | DPDT | 2 | | On | None | On | Gold Contacts 6-1437556-8 | AE201MD1CB | DPDT | 2 | | On | None | On |
| | AE203MD1CQ | DPDT | 6 | | On | Off | On | | AE203MD1CB | DPDT | 6 | | On | Off | On |
| | AE205MD1CQ | DPDT | 6 | | (On) | Off | (On) | | AE205MD1CB | DPDT | 6 | | (On) | Off | (On) |
| | AE207MD1CQ | DPDT | 6 | | On | Off | (On) | | AE207MD1CB | DPDT | 6 | | On | Off | (On) |
| | AE208MD1CQ | DPDT | 2 | | On | None | (On) | | AE208MD1CB | DPDT | 2 | | On | None | (On) |
| | AE211MD1CQ | SP3T | 11 | | On | On | On | | AE211MD1CB | SP3T | 11 | | On | On | On |
| | AE215MD1CQ | SP3T | 11 | | (On) | On | (On) | | AE215MD1CB | SP3T | 11 | | (On) | On | (On) |

Toggle Switches, AE Series, Process Sealed, Right Angle, Long Bat Actuator

* Refer to Pages C35-C38 for Additional Options *

SEE PAGE C35 FOR PRODUCT SPECIFICATIONS

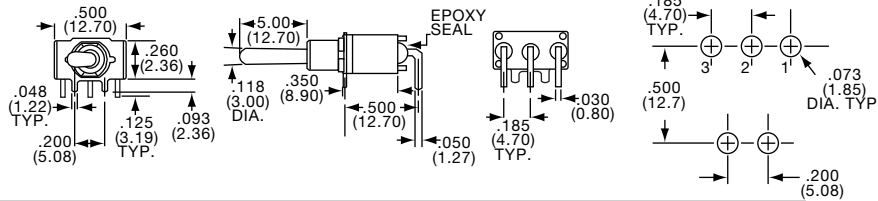

SPDT



AE101SD1AQ
Horizontal Actuation

| Tyco Electronics | Alcoswitch | Tyco Electronics | Alcoswitch | Type | Act. Code | P. M5 | | | |
|------------------------|------------|----------------------|------------|------|-----------|-------|------|------|------|
| Silver Contacts | | Gold Contacts | | | | | | | |
| 6-1437556-0 | AE101SD1AQ | 2-1437556-2 | AE101SD1AB | SPDT | 1 | | On | None | On |
| | AE103SD1AQ | | AE103SD1AB | SPDT | 5 | | On | Off | On |
| 2-1437556-3 | AE108SD1AQ | 5-1437556-9 | AE108SD1AB | SPDT | 5 | | (On) | Off | (On) |

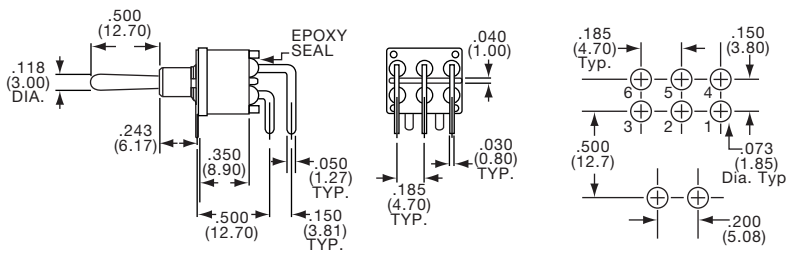

DPDT

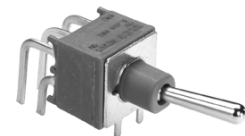

AE201SD1AB
Horizontal Actuation

| Tyco Electronics | Alcoswitch | Tyco Electronics | Alcoswitch | Type | Act. Code | P. M5 | | | |
|------------------------|------------|----------------------|------------|------|-----------|-------|------|------|------|
| Silver Contacts | | Gold Contacts | | | | | | | |
| | AE201SD1AQ | 7-1437556-1 | AE201SD1AB | DPDT | 2 | | On | None | On |
| | AE203SD1AQ | | AE203SD1AB | DPDT | 6 | | On | Off | On |
| | AE208SD1AQ | 7-1437556-9 | AE208SD1AB | DPDT | 6 | | (On) | Off | (On) |

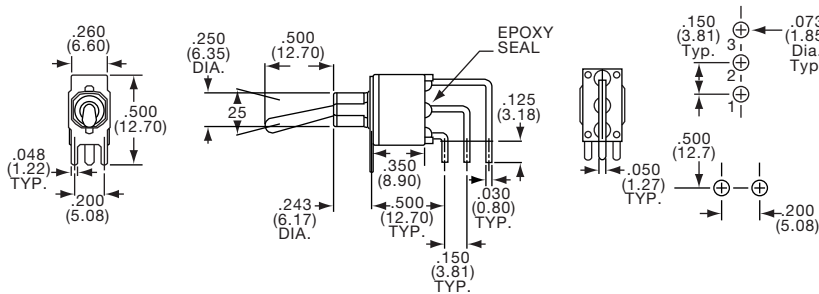

SPDT



AE101SD1AV2B
Vertical Actuation

| Tyco Electronics | Alcoswitch | Tyco Electronics | Alcoswitch | Type | Act. Code | P. M5 | | | |
|------------------------|--------------|----------------------|--------------|------|-----------|-------|------|------|------|
| Silver Contacts | | Gold Contacts | | | | | | | |
| 2-1437556-6 | AE101SD1AV2Q | 2-1437556-5 | AE101SD1AV2B | SPDT | 1 | | On | None | On |
| | AE103SD1AV2Q | 3-1437556-6 | AE103SD1AV2B | SPDT | 5 | | On | Off | On |
| | AE108SD1AV2Q | | AE108SD1AV2B | SPDT | 5 | | (On) | Off | (On) |

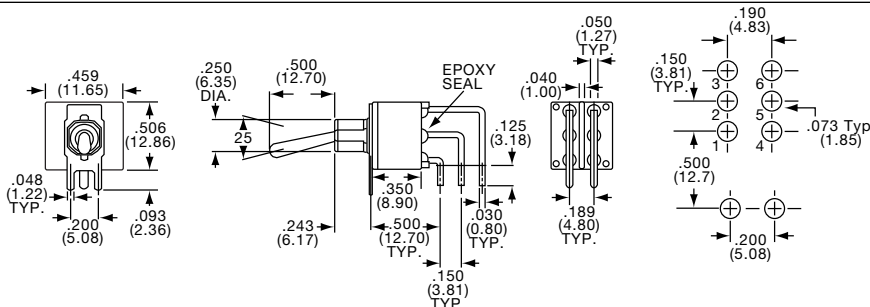

DPDT

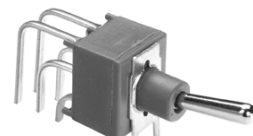

AE201SD1AV2Q
Vertical Actuation

| Tyco Electronics | Alcoswitch | Tyco Electronics | Alcoswitch | Type | Act. Code | P. M5 | | | |
|------------------------|--------------|----------------------|--------------|------|-----------|-------|------|------|------|
| Silver Contacts | | Gold Contacts | | | | | | | |
| 8-1437556-1 | AE201SD1AV2Q | 7-1437556-3 | AE201SD1AV2B | DPDT | 2 | | On | None | On |
| | AE203SD1AV2Q | 8-1437556-0 | AE203SD1AV2B | DPDT | 6 | | On | Off | On |
| | AE208SD1AV2Q | | AE208SD1AV2B | DPDT | 6 | | (On) | Off | (On) |