

ZL series

Tiny toggle switches - metal bushing

Distinctive features - Specifications - Overview



☐ Ø 4,83 mm threaded bushing

☐ Solder lug and straight PC terminals

ELECTRICAL SPECIFICATIONS

- Max. current/voltage rating with resistive load :
 - gold plated contacts : 0,4VA 20V max. AC or DC
 - silver plated contacts : 0,5A 48V max. AC or DC
- Minimum load : 10mA 50mV - 10µA 5VDC
- Contact resistance : 20 mΩ max.
- Insulation resistance : 1.000 MΩ min. at 500VDC
- Dielectric strength: 1.000 Vrms 50 Hz min. between terminals and frame
500 Vrms 50 Hz min. between terminals
- Electrical life at full load :

| Contacts | Number of cycles | |
|---------------|------------------|-------------|
| | 2 positions | 3 positions |
| Gold plated | 60.000 | 30.000 |
| Silver plated | 20.000 | 10.000 |

GENERAL SPECIFICATIONS

- Strength of terminals : pull-out force 10N max.
- Torque : 1 Nm max. applied between the 2 nuts
- Max. panel thickness : 1,5 mm (.059) with 2 nuts
- Operating temperature : -30°C to +85°C
- Moisture : 21 days 95 % (NFC 20-603 - IEC 8-2-3)

MATERIALS

- Case : thermoplastic UL94-V0
- Actuator : brass, nickel plated
- Bushing : zamac, tin plated
- Contacts and terminals :
 - 0 : brass, gold plated (standard)
 - 1 : brass, silver plated
 - 3 : brass, gold plated (1,27 micron gold)
- Terminal seal : epoxy

SOLDERING

- Hand soldering : 280°C max. for 5 seconds max.
- Wave soldering : 260°C max. for 5 seconds max.

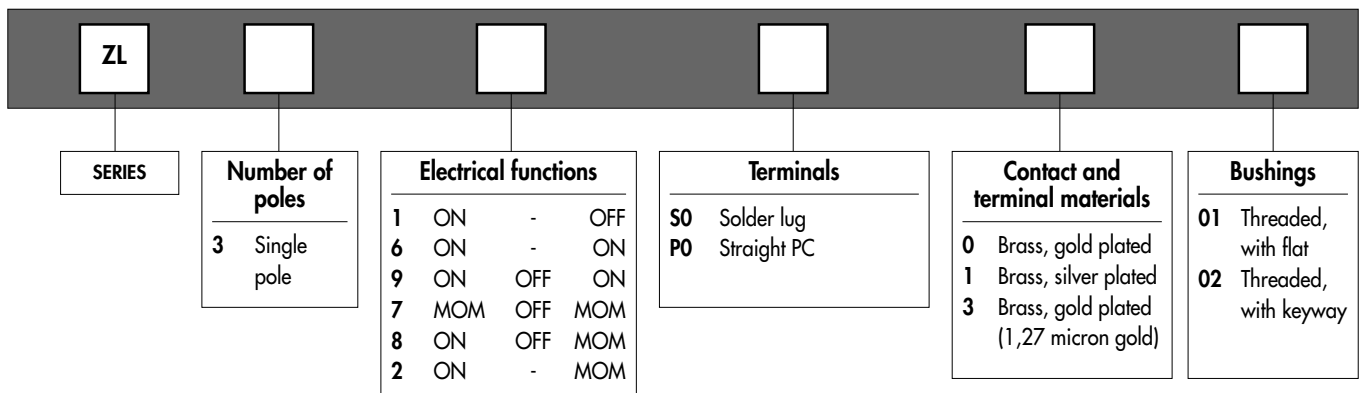

Dimensions : First dimensions are in mm while inches are shown as bracketed numbers.



Packaging unit : 100 pieces



Mounting accessories : Standard hardware supplied with all models : 2 hex nuts 7 mm (.275) across flats P/N U5731, 1 locking ring P/N U5821 (with keyway) or U5831 (with flat) and 1 lockwasher P/N U5841.

ZL series

Tiny toggle switches - metal bushing

A

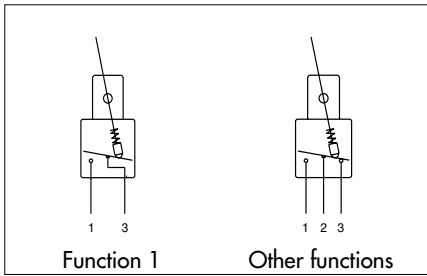

- Single pole
- Gold plated or silver plated contacts
- Epoxy sealed terminals

Other actuator lengths available on request.

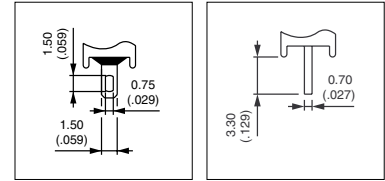

MODEL STRUCTURE



Shown with threaded bushing code 01

Solder lug terminals : ZL..S0



ZL31S0
ZL36S0
ZL39S0
ZL37S0
ZL38S0
ZL32S0

| | III | II | I |
|--------|-----|-----|-----|
| ZL31S0 | ON | - | OFF |
| ZL36S0 | ON | - | ON |
| ZL39S0 | ON | OFF | ON |
| ZL37S0 | MOM | OFF | MOM |
| ZL38S0 | MOM | OFF | ON |
| ZL32S0 | MOM | - | ON |

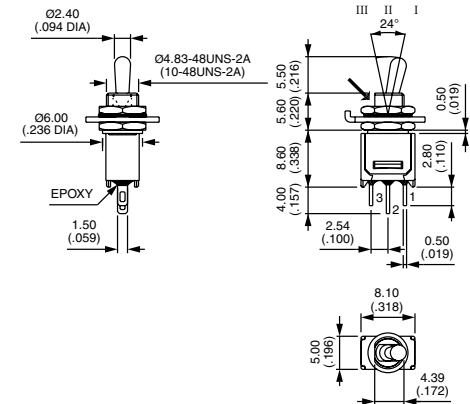

→ Flat

Straight PC terminals : ZL..PO



ZL31PO
ZL36PO
ZL39PO
ZL37PO
ZL38PO
ZL32PO

| | III | II | I |
|--------|-----|-----|-----|
| ZL31PO | ON | - | OFF |
| ZL36PO | ON | - | ON |
| ZL39PO | ON | OFF | ON |
| ZL37PO | MOM | OFF | MOM |
| ZL38PO | MOM | OFF | ON |
| ZL32PO | MOM | - | ON |

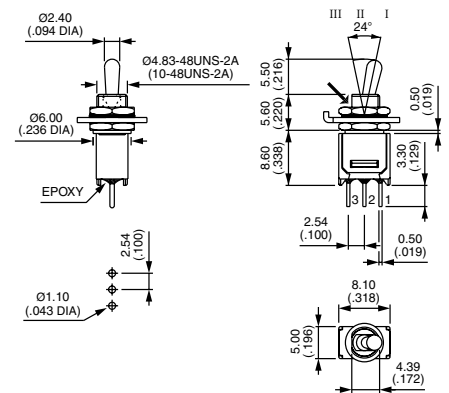

→ Flat

CONTACT & TERMINAL MATERIALS

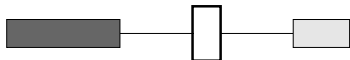

0 : Brass, gold plated (standard) - 1 : Brass, silver plated - 3 : Brass, gold plated (1,27µ gold)

BUSHINGS

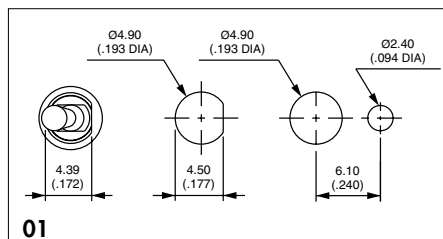
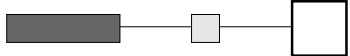

01
Threaded, with flat

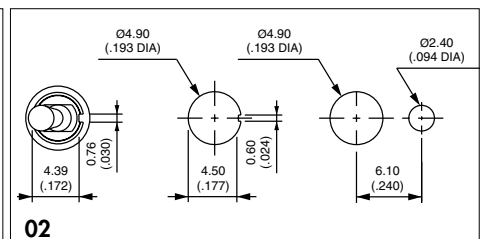

02
Threaded, with keyway