

THIS DRAWING IS UNPUBLISHED
 ALL RIGHTS RESERVED

REV	DATE	DESCRIPTION	BY	CHK	APP
00					
03		REVISED PER EDD-11-005556			OTMWR11 PSK/MW

Materials			
No.	Component name	Base material	Finish
1	Housing	High temp., UL 34V-0, green	
2	End terminal	silver clad copper alloy	5 microinches min. gold
3	Center terminal	copper alloy	5 microinches min. gold
4	Rocker contact	silver clad copper alloy	5 microinches min. gold
5	Actuator	Phenol resin, UL94 HB, black	
6	Plunger	stainless steel	
7	Spring	music wire	
8	Lever	brass	chrome or nickel
9	Retainer	Polyamide, UL94 HB, black	
10	Frame	cold rolled steel	zinc or nickel
11	Bushing	brass	100 microinches min. nickel over 10 microinches min. copper
12	Mounting nuts (2)	brass	200 microinches min. bright nickel
13	Locating ring	cold rolled steel	zinc or nickel
14	Internal tooth lockwasher	steel	zinc or nickel
15	Upper toggle cap	Aluminum	matte
16	Lower toggle cap	Aluminum	matte
17	Retaining pin	steel	

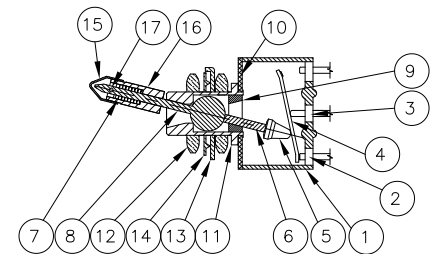

NOT TO SCALE

Specifications-see note 3				
Current rating UL & CSA	6A @ 125 VAC (resistive)			
	3A @ 250 VAC (resistive)			
	4A @ 28 VDC (resistive)			
Termination resistance	20 milliohms max @ 2-4 VDC, 1A			
Insulation resistance	1,000 megohms min.			
Withstanding voltage	1,000 VAC			
Travel	24 +/- 6 degrees			
Actuation force	.05 to 1.5 kaf			
Operating temperature	-20C to +85C			
Storage temperature	-40C to +85C			
Contact timing	break before make			
Terminal seal	epoxy or insert molded			
Durability	Parameter	2 Position	3 Position	Momentary
	mechanical (no load)	150,000	100,000	80,000
	250 VAC (3A resistive)	80,000	60,000	60,000
	125 VAC (6A resistive)	80,000	60,000	60,000
	28 VDC (4A resistive)	60,000	50,000	40,000

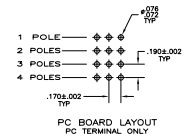
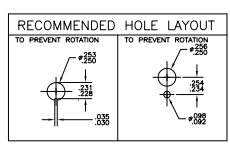

- NOTES:
- TERMINAL NUMBERS ARE FOR REFERENCE ONLY AND DO NOT APPEAR ON THE SWITCHES.
 - EACH SWITCH SUPPLIED WITH THE FOLLOWING MOUNTING HARDWARE:
 - (2) 1/4-40 UNS-2B HEX NUTS
 - (1) INTERNAL TOOTH LOCKWASHER
 - (1) LOCATING RING
 - WIRE LUG CONTACTS WILL ACCEPT 2 #20 AWG SOLID OR STRANDED WIRES.
 - CUSTOMER INSTALLED EXTERNAL JUMPER BETWEEN TERMINALS 2 AND 4 REQUIRED FOR 1 POLE 3 THROW FUNCTION.
 - CUSTOMER INSTALLED EXTERNAL JUMPERS BETWEEN TERMINALS 2 AND 4 AS WELL AS 8 AND 10 REQUIRED FOR 2 POLE 3 THROW FUNCTION.
- ⚠️ OBSOLETE

Part Number	Alco Model	Poles	Throws	Function	Terminal	Terminal	Terminal	Terminal	Comments
4-1437559-5	MTL406PA	2	3	ON ON ON	Wire lug	5-6, 11-12	5-3, 11-9	5-1, 11-7	note 7
4-1437559-4		4	2	ON ON	Wire lug	2-3, 5-6, 8-9, 11-12	---	2-1, 5-4, 8-7, 11-10	
4-1437559-3		3	2	ON OFF ON	Wire lug	2-3, 5-6, 8-9	Off	2-1, 5-4, 8-7	
4-1437559-2		3	2	ON ON	Wire lug	2-3, 5-6, 8-9	---	2-1, 5-4, 8-7	
4-1437559-1		2	2	(ON) OFF (ON)	Wire lug	2-3, 5-6	Off	2-1, 5-4	
4-1437559-0	MTL206PA	1	3	ON ON ON	Wire lug	5-6	5-3	5-1	note 6
3-1437559-9		2	2	ON OFF ON	Wire lug	2-3, 5-6	Off	2-1, 5-4	
3-1437559-8	MTL206NPC	2	2	ON ON	PC	2-3, 5-6	---	2-1, 5-4	
3-1437559-7		2	2	ON ON	Wire lug	2-3, 5-6	---	2-1, 5-4	
3-1437559-6	MTL106EUL	1	2	ON OFF ON	Wire lug	2-3	Off	2-1	
3-1437559-5		1	2	ON OFF ON	Wire lug	2-3	Off	2-1	
3-1437559-4		1	2	ON ON	Wire lug	2-3	---	2-1	

THIS DRAWING IS A CONTROLLED DOCUMENT.

TE Connectivity
 TOGGLE SWITCH/MTL SERIES
 VERTICAL MOUNT

DATE: 000779
 DRAWING NO: 3-1437559-7
 REVISED TO: ---

CUSTOMER DRAWING

REV	DATE	DESCRIPTION	BY	CHK	APP
AD	00	SEE SHEET 1	-	-	-

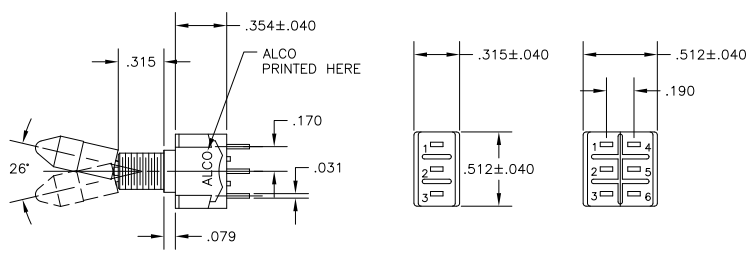

MTL-106 MTL-206

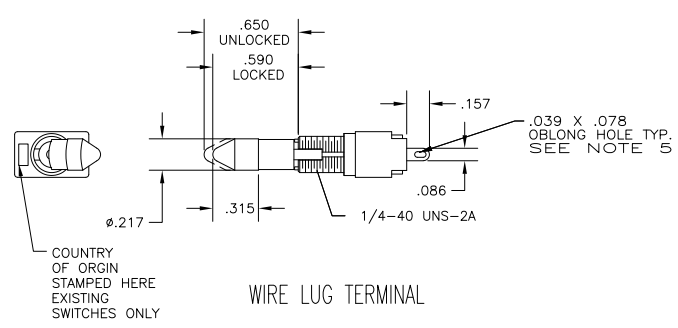

WIRE LUG TERMINAL

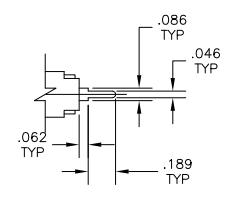

PC TERMINAL

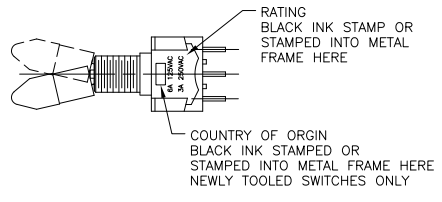

THIS DRAWING IS A CONTROLLED DOCUMENT.		BY: [signature]	DATE: [date]	REV: [rev]	DATE: [date]	REV: [rev]	DATE: [date]	REV: [rev]	DATE: [date]	REV: [rev]
DESIGNED BY: [signature]	DESIGNED DATE: [date]	CHECKED BY: [signature]	CHECKED DATE: [date]	APPROVED BY: [signature]	APPROVED DATE: [date]	ETE Connectivity TOGGLE SWITCH/MTL SERIES VERTICAL MOUNT				
PART NO: [part no]		SIZE: [size]		DRAWING NO: [drawing no]		REV: [rev]		REWORKED TO: [rework to]		
MATERIAL: [material]		SPEC: [spec]		A1 00779		3-1437559-7		SCALE: 1:1 SHEET 2 OF 3		
CUSTOMER DRAWING										

THIS DRAWING IS UNPUBLISHED
 ALL RIGHTS RESERVED

REV	DATE	BY	CHK	APP	DESCRIPTION
AD	00				SEE SHEET 1

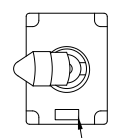
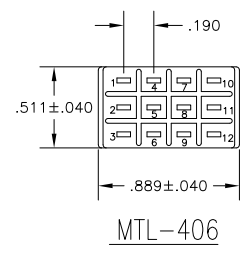
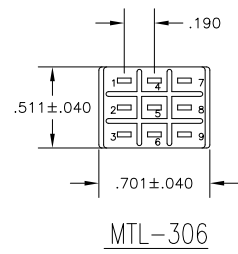
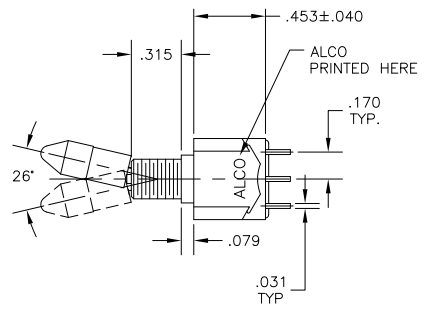

COUNTRY OF ORIGIN STAMPED HERE EXISTING SWITCHES ONLY

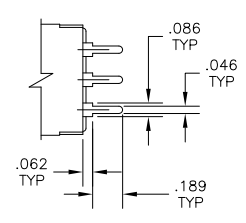
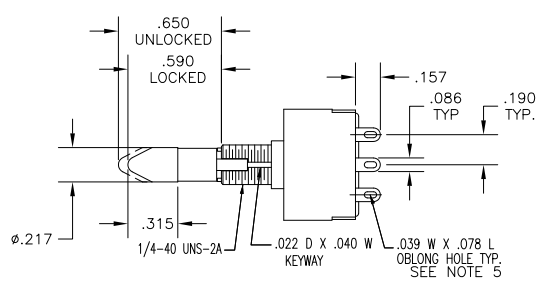

WIRE LUG TERMINAL

PC TERMINAL

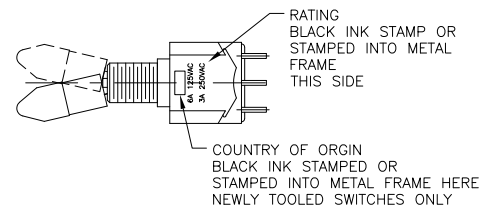

THIS DRAWING IS A CONTROLLED DOCUMENT.		REV	DATE	BY	CHK	APP	DESCRIPTION
DESIGNED	BY	DATE	BY	CHK	APP	DESCRIPTION	
DRG	BY	DATE	BY	CHK	APP	DESCRIPTION	
CHK	BY	DATE	BY	CHK	APP	DESCRIPTION	
APP	BY	DATE	BY	CHK	APP	DESCRIPTION	
CUSTOMER DRAWING		REV	DATE	BY	CHK	APP	DESCRIPTION
		REV	DATE	BY	CHK	APP	DESCRIPTION