

# 5000 series

## Toggle switches

*Distinctive features*

UG1006-A

### THE WIDEST RANGE IN MINIATURE SWITCHES

A



- 17 actuators including toggles, paddle levers and locking levers in different lengths.

- 5 contact materials from dry circuit to 6A 125VAC and high inrush up to 120A 2 ms.

- 8 functions including maintained and momentary versions.

- 1 to 4 pole configurations.



- 12 terminal types including 9 for PC board mounting. Other types include quick-connect and wire-wrap.

- 6 bushing styles from 6 (.236) plain to 11,9 (15/32) threaded.

- 3 types of finish including military black.

- 4 approvals (UL - CSA - VDE - CECC) and 3 listings.



- 4 types of sealing for terminal or front panel requirements.

- Numerous accessories available for actuator and bushing options.

# 5000 series

## Toggle switches

### Specifications

#### ELECTRICAL SPECIFICATIONS

- Current/voltage rating with resistive load :

Contact	Maximum	Minimum	Level*
Silver (A)	3A 250VAC - 6A 125VAC - 4A 30VDC	50mA 10VDC	III and IV
Silver, gold plated (AD)	3A 250VAC - 6A 125 VAC - 4A 30VDC Gold plating withstands up to 100mA 30VDC	10mA 50mV 10µA 5V	I to IV
Brass, gold plated (CD)	0,4 VA at 20VAC or DC	10mA 50mV 10µA 5V	I and II

- For inductive, lamp or capacitive load, consult factory. \* For details, see Technical Information, end of catalogue.
- Initial contact resistance : 10 mΩ max.
- Insulation resistance : 1.000 MΩ min. at 500VDC
- Dielectric strength :
  - 1.000 Vrms 50 Hz min. between terminals
  - 1.500 Vrms 50 Hz min. between poles
  - 1.500 Vrms 50 Hz min. between terminals and frame
- Contact bounce : 2 ms max.
- Electrical life at full load :
  - 50.000 cycles for single and double pole
  - 40.000 cycles for 3 pole
  - 30.000 cycles for 4 pole
- Low level or mechanical life : 100.000 cycles

#### MATERIALS

- Case : diallyphthalate (DAP) or high temperature plastic material (UL94-V0)
- Actuator : brass, nickel plated
- Paddles : UL94HB polyamide
- Lever caps : vinyl
- Bushing : brass, nickel plated
- Housing : stainless steel or steel tin plated
- Contacts
  - A : silver
  - AD : silver, gold plated
  - CD : brass, gold plated
  - X814 : for peak currents, see "Special options".
- Terminal seal : epoxy

#### GENERAL SPECIFICATIONS

- Torque : 1,25 Nm (.922 Ft.lb) max. applied to nut
- Panel thickness : 2,5 mm (.098) with 2 nuts - 4 mm (.157) with 1 nut
- Operating temperature : -40°C to +85°C

#### AGENCY APPROVALS/PREFERENTIAL LIST



EN 61058-1



CECC 96201-007

For VDE, refer to 55000 series.

#### NATO

**Availability** : consult factory for details of approved models.

**Marking** : to order switches marked UL, CSA or CECC, complete appropriate box of ordering format. The preferential list does not appear on the switches.

# 5000 series

## Toggle switches

### Overview



5

SERIES

Number of poles

- 3 Single pole
- 4 Double pole
- 5 Three pole
- 6 Four pole

Terminals

- Blank** Solder lugs or straight PC depending on model
- M** Solder lugs with Ø 11,9 (15/32) bushing (5600 switches)
- MIWR** Wire wrap (for 5200 switches only)
- W** Right angle, horizontal mounting (5200 - 5400 switches)
- WW** Right angle, vertical mounting (5200 - 5400 switches)
- Y** ]
- Y4** ] Bracket mounting (5200 switches)
- Y6** ]
- Y7** ]
- Z** Quick connect (5200 - 5100 - 5900 switches)

Terminals and bushing

- 0** Straight PC terminals, 5,08 (.200) terminal spacing, **with Ø 6,35 (1/4)** threaded bushing
- 1** Straight PC or quick-connect terminals, 4,70 (.185) terminal spacing, **with Ø 6 (.236)** threaded bushing.
- 2** Straight PC terminals, 4,70 (.185) terminal spacing, right angle, quick-connect or wire wrap terminals, **with 6,35 (1/4)** threaded bushing
- 3** Straight PC terminals, 4 (.157) terminal spacing, **with Ø 6 (.236)** threaded bushing
- 4** Straight PC terminals, 4 (.157) terminal spacing or right angle terminals, **with Ø 6,35 (1/4)** threaded bushing
- 5** Solder lug terminals, **with Ø 6 (.236)** threaded bushing.
- 6** Solder lug terminals, **with Ø 6,35 (1/4) or Ø 11,9 (15/32)** threaded bushing.
- 7** Solder lug terminals, with Ø 6,35 (1/4) **flatted** bushing.
- 9** Straight PC or quick-connect terminals, with Ø 6,35 (1/4) **flatted** bushing, 4,70 (.185) terminal spacing.

Electrical functions

6	ON	-	ON
9	ON	OFF	ON
7	MOM	OFF	MOM
8	ON	OFF	MOM
2	ON	-	MOM
4	ON	ON	ON
	ON	ON	MOM ▲
	MOM	ON	MOM ▲

Function 4

Must not have blank in "connections" box.  
 ▲ Must not have blank in "momentary" box.

Connections for function 4

- TH** Standard
  - CT** Reversed
- See wiring diagrams end of catalogue.  
 . For functions 4, 4-1R, 4-2R (leave blank for all other functions).

Momentary for function 4

- 1R** ON ON MOM
  - 2R** MOM ON MOM
- Leave blank for other functions.

#### ABOUT THIS SERIES

- On the following pages, you will find successively :
- model structure of switches with threaded bushing
  - model structure of switches with plain bushing
  - options in the same order as in above chart

**Dimensions** : first dimensions are in mm while inches are shown as bracketted numbers.



**NOTICE** : please note that not all combinations of above numbers are available. Refer to the following pages for further information.



# 5000 series

## Toggle switches

### Overview

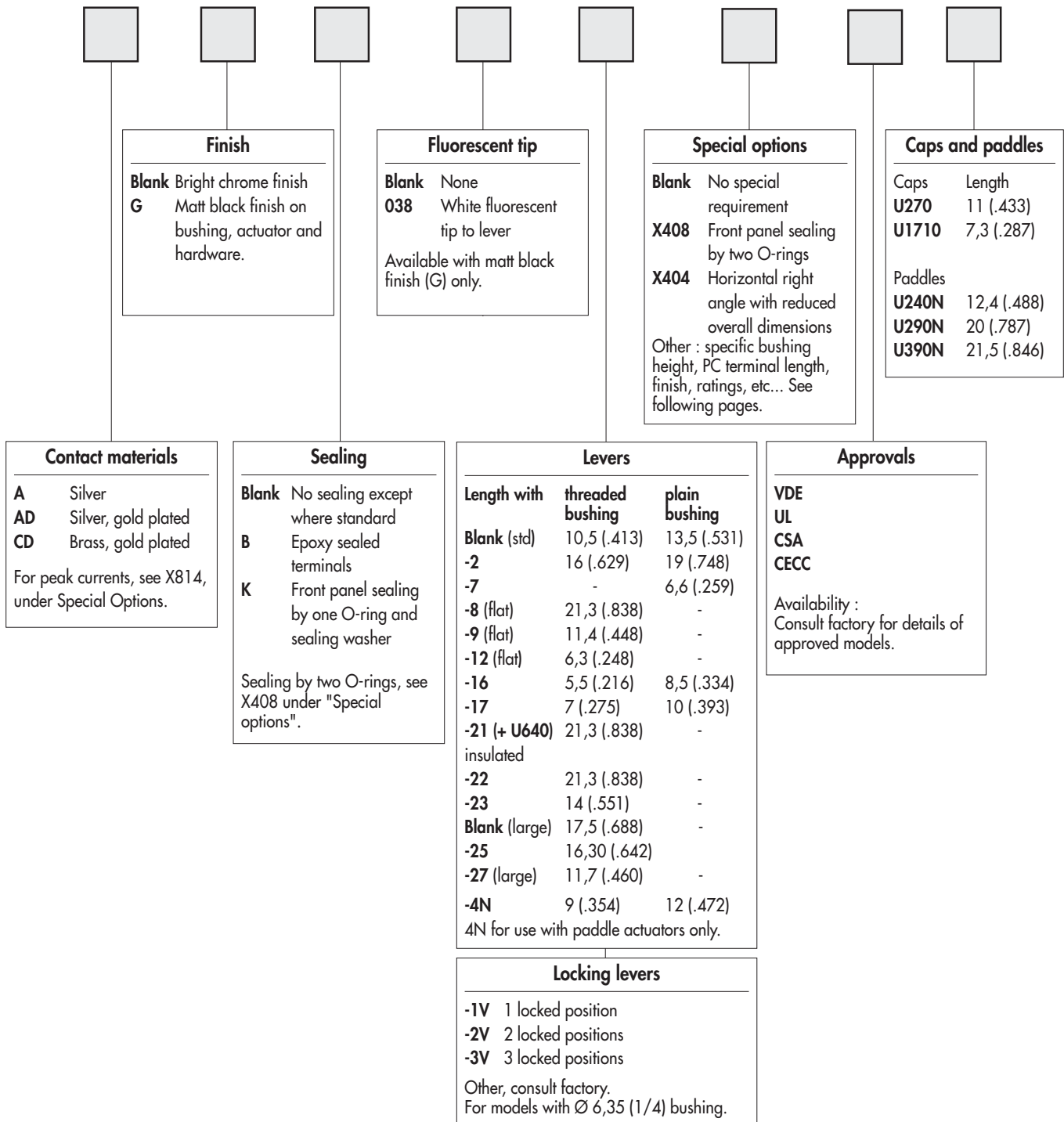

**Sealing boots** are available. They are presented in section H.



**Mounting accessories** : standard hardware supplied with all models with Ø 6,35 (1/4) or Ø 6 (.236) threaded bushing : 2 hex nuts 8 mm (.314) across flats, 1 locking ring and 1 lockwasher. Standard and special hardware available are presented in section I.



**Packaging unit** : 25 pieces or 50 pieces depending on models.

# 5000 series

Toggle switches - solder lug terminals

Threaded bushing  $\varnothing 6,35$  (1/4) : 5600



A

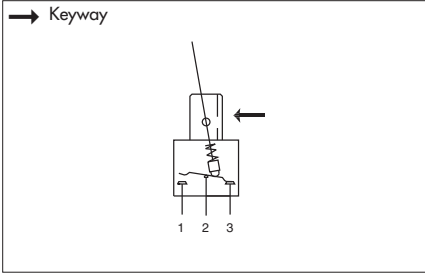

• 1, 2, 3 and 4 pole configurations

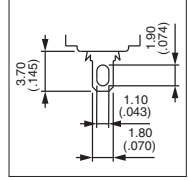

MODEL STRUCTURE

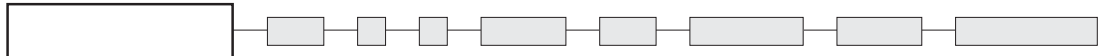

Shown with standard lever

## Single pole



5636  
5639  
5637  
5638  
5632

III	II	I
2-3		1-2
ON	-	ON
ON	OFF	ON
MOM	OFF	MOM
ON	OFF	MOM
ON	-	MOM

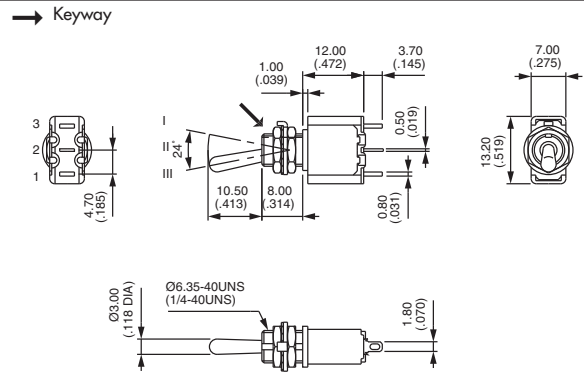

## Double pole



5646  
5649  
5647  
5648  
5642  
5644\*  
5644 1R\*  
5644 2R\*

III	II	I
2-3		1-2
5-6		4-5
ON	-	ON
ON	OFF	ON
MOM	OFF	MOM
ON	OFF	MOM
ON	-	MOM
ON	ON	ON
ON	ON	MOM
MOM	ON	MOM

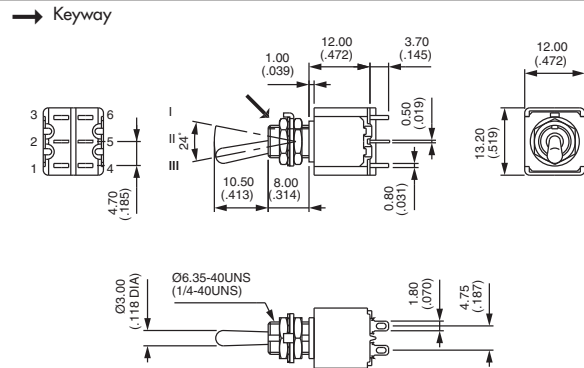

\* Function 4 : SP in DP case - specify CT or TH connections, see end of catalogue.

## Three pole



5656  
5659  
5657  
5658  
5652

III	II	I
2-3		1-2
5-6		4-5
8-9		7-8
ON	-	ON
ON	OFF	ON
MOM	OFF	MOM
ON	OFF	MOM
ON	-	MOM

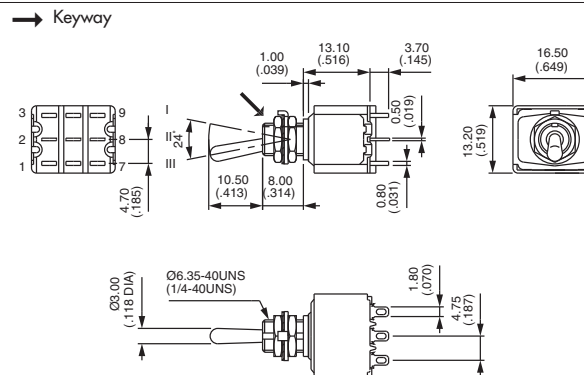



# 5000 series

Toggle switches - solder lug terminals



A

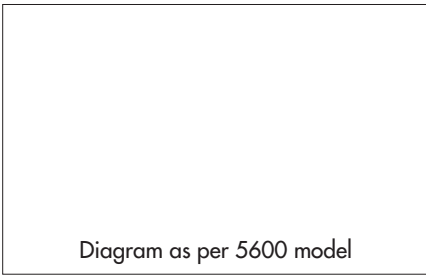

## 5700 models

- Flatted bushing  $\varnothing$  6,35 mm (1/4)
- 1, 2, 3 and 4 pole configurations

MODEL  
STRUCTURE

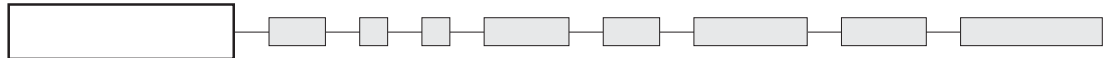

For model structure numbers, refer to 5600 models and replace 6 with 7.

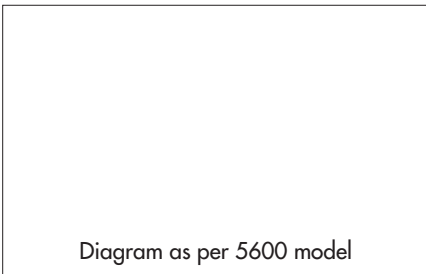
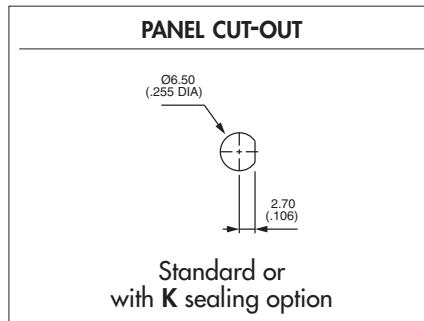

## 5500 models

- Threaded bushing  $\varnothing$  6 mm x 0.75 SI (.236 x 0.75 IS)
- 1, 2, 3 and 4 pole configurations

MODEL  
STRUCTURE

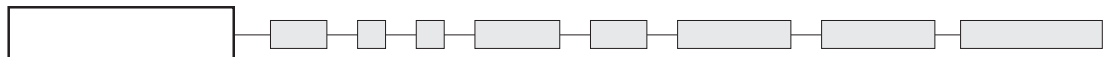

For model structure numbers, refer to 5600 models and replace 6 with 5.

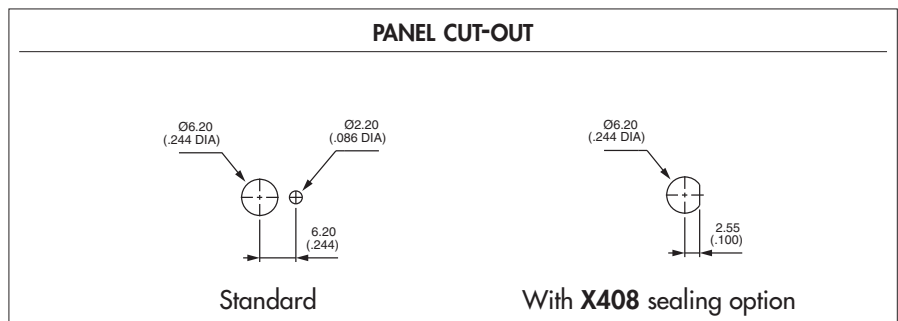



# 5000 series

## Toggle switches - solder lug terminals

Threaded bushing  $\varnothing 11,9$  (15/32) : 5600M

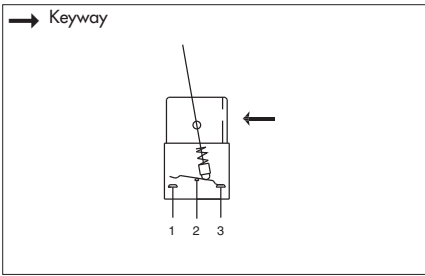

- 1, 2, 3 and 4 pole configurations
- Supplied with 2 hex nuts and 1 locking ring
- Panel thickness up to 6 mm (.236)

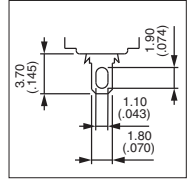

### MODEL STRUCTURE

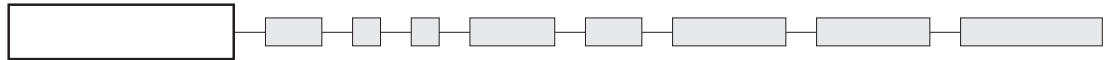

Shown with standard lever

### Single pole



5636M  
5639M  
5637M  
5638M  
5632M

III	II	I
2-3		1-2
ON	-	ON
ON	OFF	ON
MOM	OFF	MOM
ON	OFF	MOM
ON	-	MOM

→ Keyway

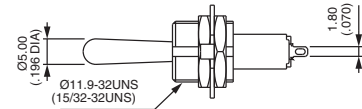
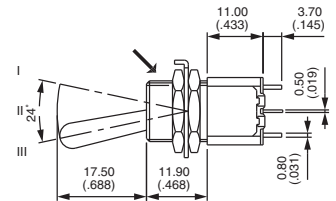
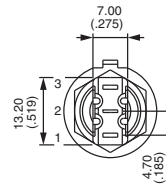

### Double pole



5646M  
5649M  
5647M  
5648M  
5642M  
5644M\*  
5644M 1R\*  
5644M 2R\*

III	II	I
2-3		1-2
5-6		4-5
ON	-	ON
ON	OFF	ON
MOM	OFF	MOM
ON	OFF	MOM
ON	-	MOM
ON	ON	ON
ON	ON	MOM
MOM	ON	MOM

→ Keyway

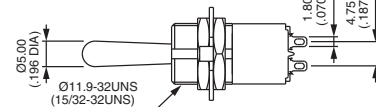
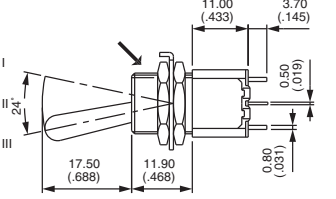
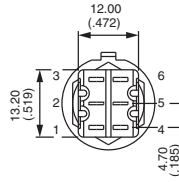

\* Function 4 : SP in DP case - specify CT or TH connections, see end of catalogue.

### Three pole



5656M  
5659M  
5657M  
5658M  
5652M

III	II	I
2-3		1-2
5-6		4-5
8-9		7-8
ON	-	ON
ON	OFF	ON
MOM	OFF	MOM
ON	OFF	MOM
ON	-	MOM

→ Keyway

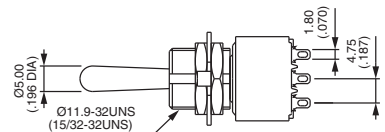
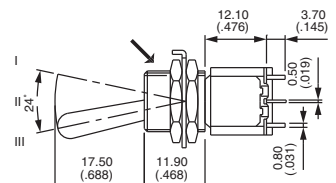
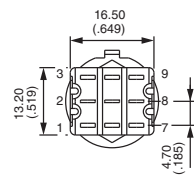



# 5000 series

## Toggle switches - solder lug terminals

Threaded bushing  $\varnothing 11,9$  (15/32) : 5600M



### Four pole



5666M  
5669M  
5667M  
5668M  
5662M  
5664M\*  
5664M 1R\*  
5664M 2R\*

III	II	I
2-3		1-2
5-6		4-5
8-9		7-8
11-12	10-11	
ON	-	ON
ON	OFF	ON
MOM	OFF	MOM
ON	OFF	MOM
ON	-	MOM
ON	ON	ON
ON	ON	MOM
MOM	ON	MOM

→ Keyway

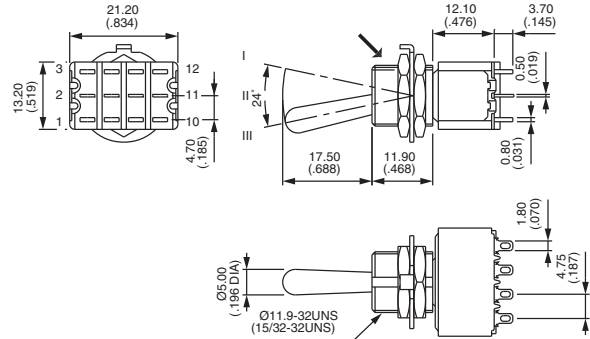

\*Function 4 : DP in 4P case - specify CT or TH connections, see end of catalogue.

### PANEL CUT-OUT

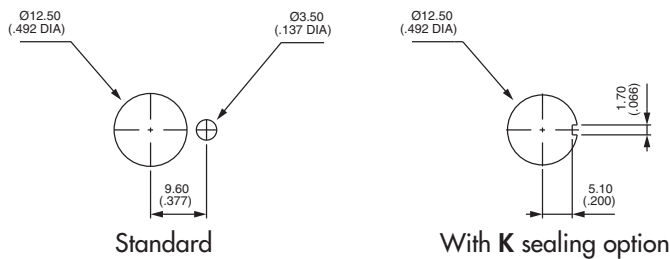

OTHER : M bushing can be combined with other types such as : 5200, Z, MIWR... Consult factory.



# 5000 series

## Toggle switches - straight PC terminals

Threaded bushing  $\varnothing 6.35$  (1/4) : 5200

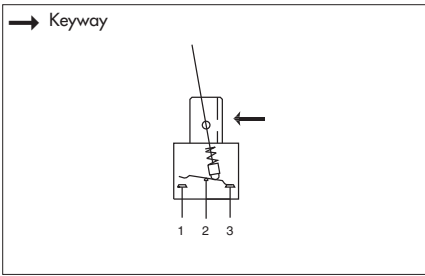

- Terminal spacing 4,7 mm (.185)
- 1, 2, 3 and 4 pole configurations
- Epoxy sealed terminals standard

For new projects, we recommend switches with support bracket (option Y) which holds the switch securely on the PCB.

Other terminal lengths presented under "Special options".

Also available with plain bushing, see "Special options" X371

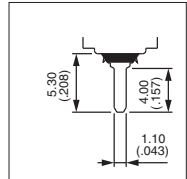

A

### MODEL STRUCTURE

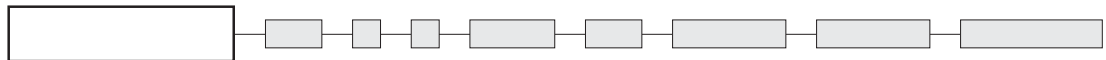

Shown with standard lever

### Single pole



- 5236 B
- 5239 B
- 5237 B
- 5238 B
- 5232 B

III	II	I
2-3		1-2
ON	-	ON
ON	OFF	ON
MOM	OFF	MOM
ON	OFF	MOM
ON	-	MOM

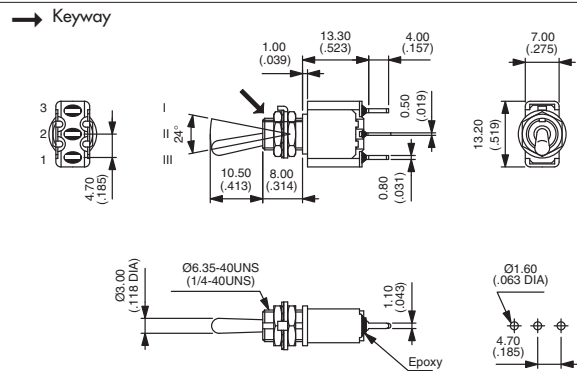

### Double pole



- 5246 B
- 5249 B
- 5247 B
- 5248 B
- 5242 B
- 5244 B\*
- 5244 1R B\*
- 5244 2R B\*

III	II	I
2-3		1-2
5-6		4-5
ON	-	ON
ON	OFF	ON
MOM	OFF	MOM
ON	OFF	MOM
ON	-	MOM
ON	ON	ON
ON	ON	MOM
MOM	ON	MOM

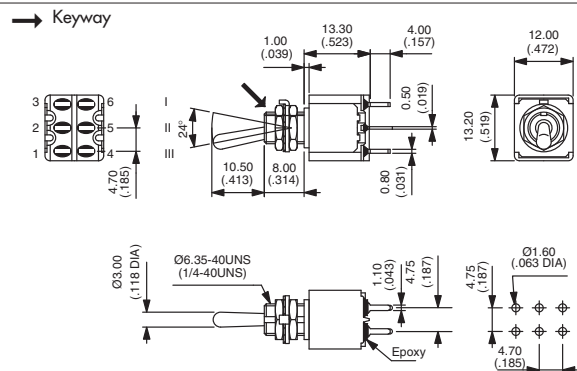

\*Function 4 : SP in DP case - specify CT or TH connections, see end of catalogue.

### Three pole



- 5256 B
- 5259 B
- 5257 B
- 5258 B
- 5252 B

III	II	I
2-3		1-2
5-6		4-5
8-9		7-8
ON	-	ON
ON	OFF	ON
MOM	OFF	MOM
ON	OFF	MOM
ON	-	MOM

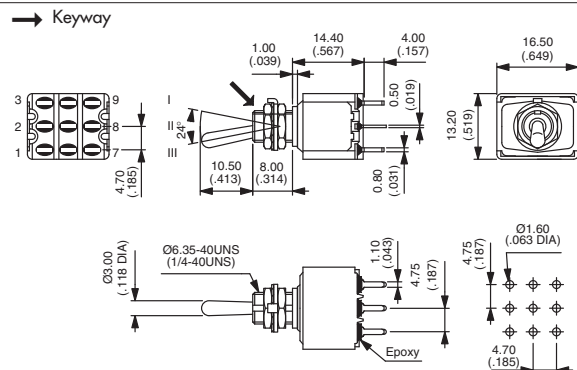





# 5000 series

Toggle switches - straight PC terminals

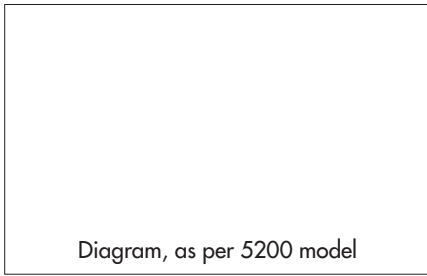

## 5400 models

- Threaded bushing  $\varnothing$  6,35 mm (1/4)
- Terminal spacing 4 mm (.157)
- 1, 2, 3 and 4 pole configurations

MODEL  
STRUCTURE

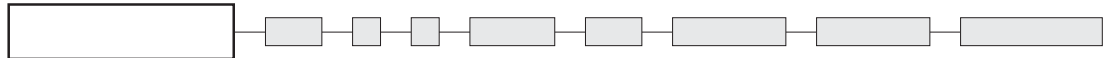

For model structure numbers, refer to 5200 models and replace 2 with 4.

Panel cut-out, see 5200.

A

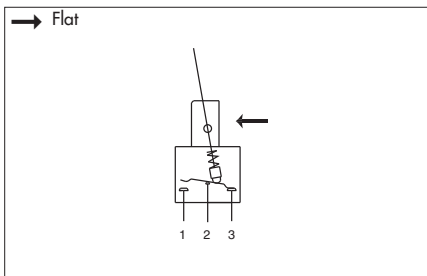

## 5900 models

- Flatted bushing  $\varnothing$  6,35 mm (1/4)
- Terminal spacing 4,7 mm (.185)
- 1, 2, 3 and 4 pole configurations

MODEL  
STRUCTURE

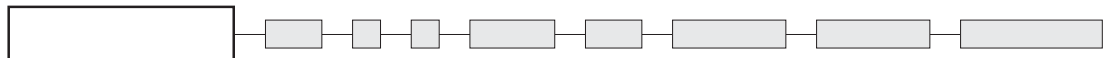

For model structure numbers, refer to 5200 models and replace 2 with 9.

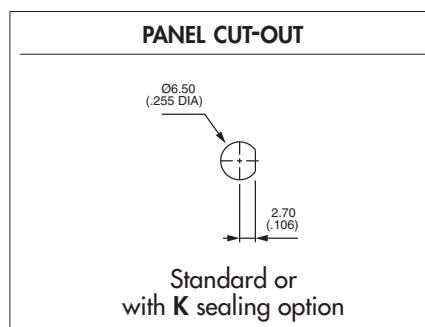

# 5000 series

Toggle switches - straight PC terminals



A

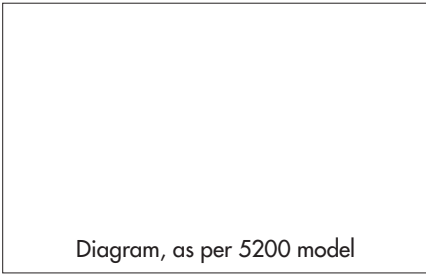

## 5100 models

- Threaded bushing  $\varnothing$  6 mm x 0.75 SI (.236 x 0.75 IS)
- Terminal spacing 4,7 mm (.185)
- 1, 2, 3 and 4 pole configurations

### MODEL STRUCTURE

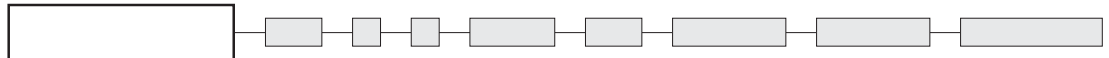

For model structure numbers, refer to **5200** models and replace 2 with 1.  
Panel cut-out, see below.

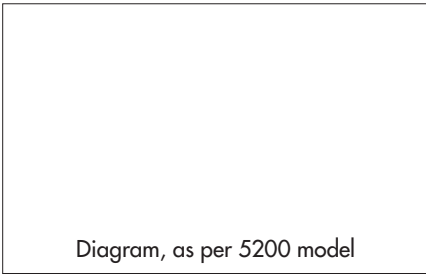

## 5300 models

- Threaded bushing  $\varnothing$  6 mm x 0.75 SI (.236 x 0.75 IS)
- Terminal spacing 4 mm (.157)
- 1, 2, 3 and 4 pole configurations

### MODEL STRUCTURE

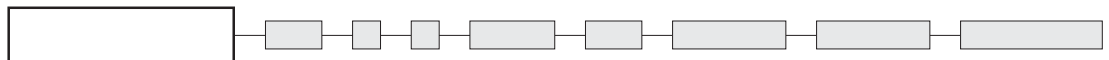

For model structure numbers, refer to **5200** models and replace 2 with 3.

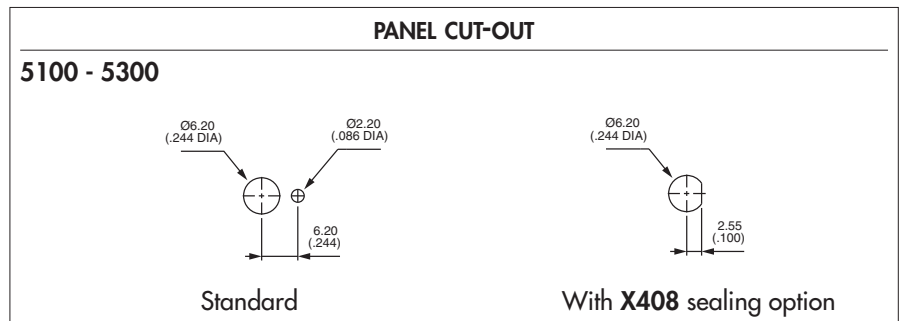



# 5000 series

## Toggle switches - quick-connect terminals

Threaded bushing  $\varnothing 6,35$  (1/4) : 5200Z

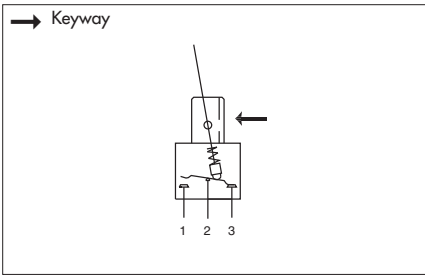

- Terminal spacing 4,7 mm (.185)
- Epoxy sealed terminals standard
- 1 and 2 pole configurations

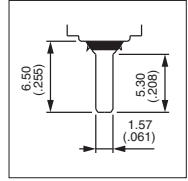

A

MODEL STRUCTURE

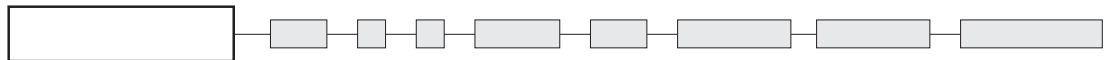

Shown with standard lever

### Single pole



5236Z  
5239Z  
5237Z  
5238Z  
5232Z

III	II	I
2-3		1-2
ON	-	ON
ON	OFF	ON
MOM	OFF	MOM
ON	OFF	MOM
ON	-	MOM

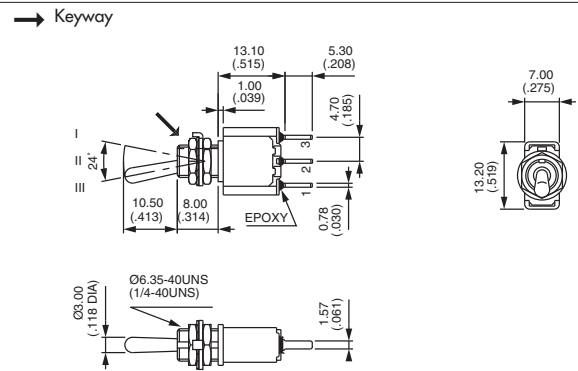

### Double pole



5246Z  
5249Z  
5247Z  
5248Z  
5242Z  
5244Z\*  
5244Z 1R\*  
5244Z 2R\*

III	II	I
2-3		1-2
5-6		4-5
ON	-	ON
ON	OFF	ON
MOM	OFF	MOM
ON	OFF	MOM
ON	-	MOM
ON	ON	ON
ON	ON	MOM
MOM	ON	MOM

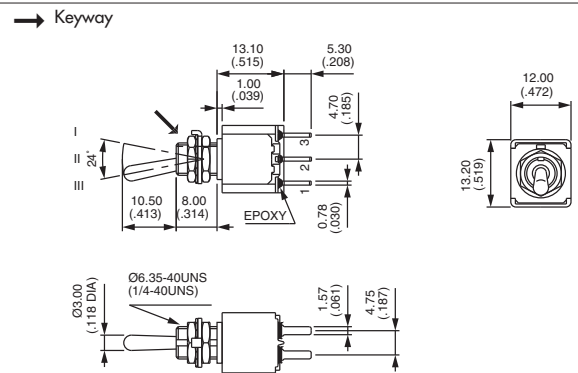

\*Function 4 : SP in DP case - specify CT or TH connections, see end of catalogue.

### PANEL CUT-OUT

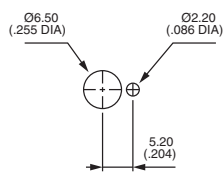

Standard

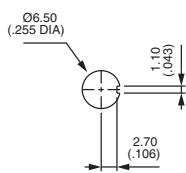

With K sealing option

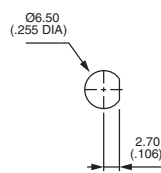

With X408 sealing option

# 5000 series

Toggle switches - quick-connect terminals



A

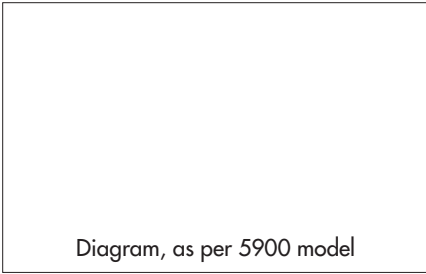

## 5900Z models

- Flatted bushing  $\varnothing$  6,35 mm (1/4)
- Terminal spacing 4,7 mm (.185)
- Epoxy sealed terminals standard
- 1 and 2 pole configurations

### MODEL STRUCTURE

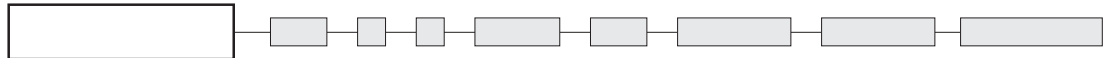

For model structure numbers, refer to 5200Z models and replace 2 with 9.

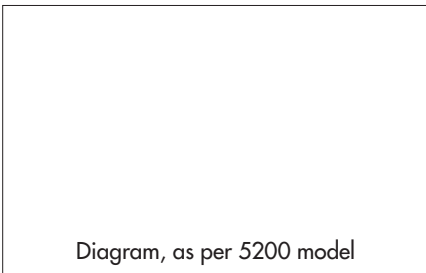
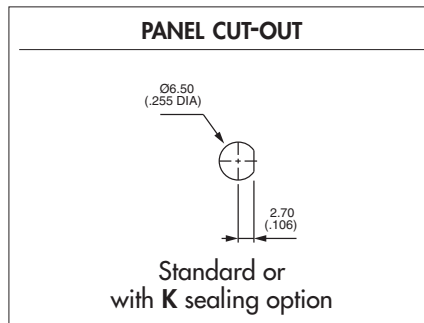

## 5100Z models

- Threaded bushing  $\varnothing$  6 mm x 0.75 SI (.236 x 0.75 IS)
- Terminal spacing 4,7 mm (.185)
- Epoxy sealed terminals standard
- 1 and 2 pole configurations

### MODEL STRUCTURE

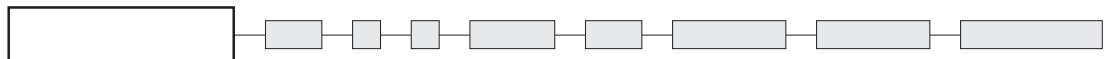

For model structure numbers, refer to 5200Z models and replace 2 with 1.

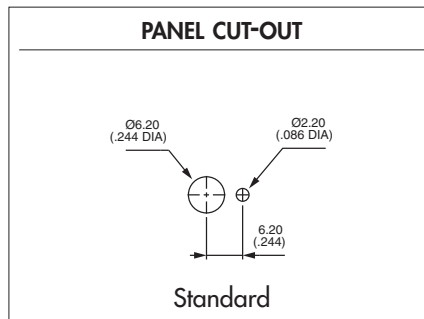



# 5000 series

Toggle switches - wire-wrap terminals

Threaded bushing  $\varnothing 6,35$  (1/4) : 5200MIWR

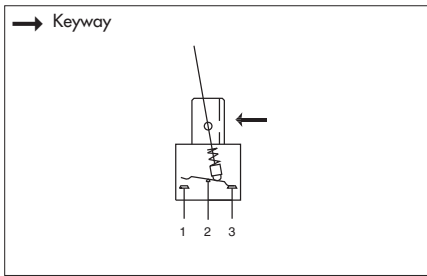

- Terminal spacing 5,08 mm (.200)
- Epoxy sealed terminals standard
- 1 and 2 pole configurations
- Can also be used as extended PCB terminals

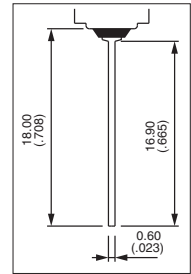

A

MODEL STRUCTURE

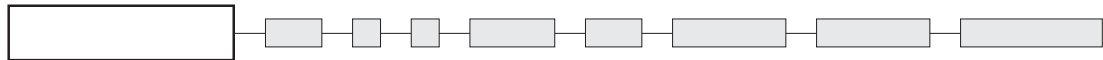

Shown with standard lever

## Terminal spacing 5,08 (.200) - single pole



5236MIWR  
5239MIWR  
5237MIWR  
5238MIWR  
5232MIWR

III	II	I
2-3		1-2
ON	-	ON
ON	OFF	ON
MOM	OFF	MOM
ON	OFF	MOM
ON	-	MOM

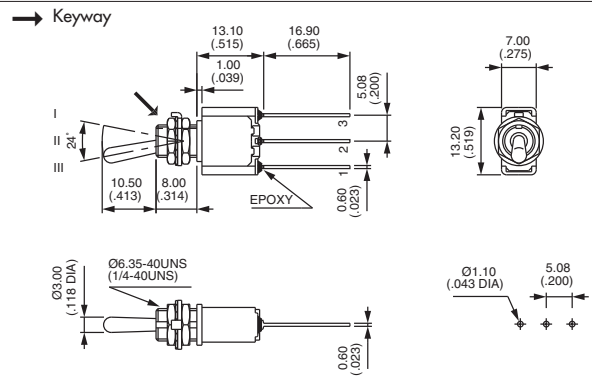

## Terminal spacing 5,08 (.200) - double pole



5246MIWR  
5249MIWR  
5247MIWR  
5248MIWR  
5242MIWR  
5244 MIWR\*  
5244 1R MIWR\*  
5244 2R MIWR\*

III	II	I
2-3		1-2
5-6		4-5
ON	-	ON
ON	OFF	ON
MOM	OFF	MOM
ON	OFF	MOM
ON	-	MOM
ON	ON	ON
ON	ON	MOM
MOM	ON	MOM

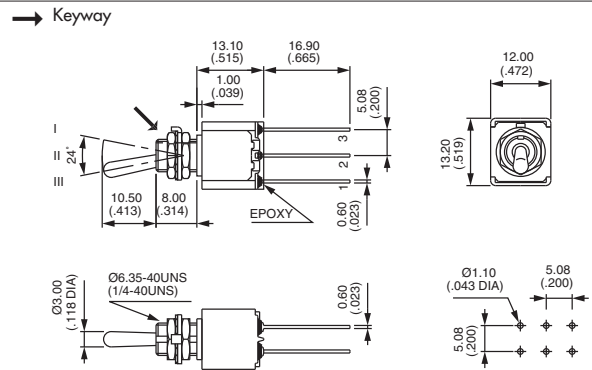

\*Function 4 : SP in DP case - specify CT or TH connections, see end of catalogue.

### PANEL CUT-OUT

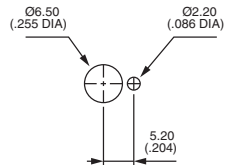

Standard

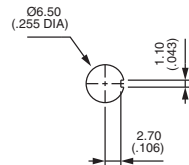

With K sealing option

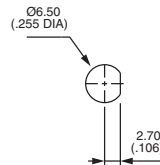

With X408 sealing option



# 5000 series

## Toggle switches - plain bushing

Right angle terminals - horizontal : 5200W

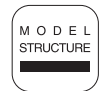

A

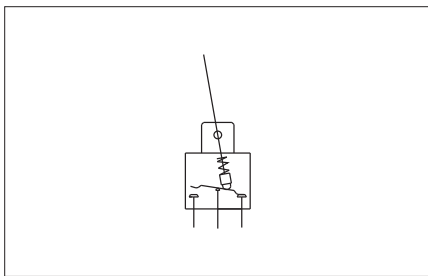

- Terminal spacing 4,7 mm (.185)
- 1, 2 and 3 pole configurations

Special switch **5200WX404** with reduced overall dimensions is presented under "Special options".

MODEL STRUCTURE

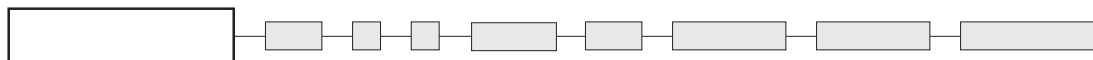

Shown with standard lever

### Single pole



5236W  
5239W  
5237W  
5238W  
5232W

III	II	I
2-3		1-2
ON	-	ON
ON	OFF	ON
MOM	OFF	MOM
ON	OFF	MOM
ON	-	MOM

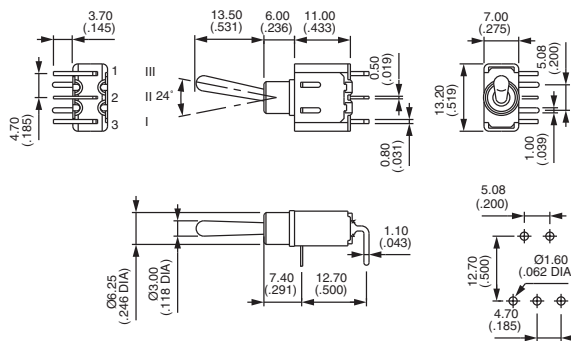

### Double pole



5246W  
5249W  
5247W  
5248W  
5242W  
5244W\*  
5244W 1R\*  
5244W 2R\*

III	II	I
2-3		1-2
5-6		4-5
ON	-	ON
ON	OFF	ON
MOM	OFF	MOM
ON	OFF	MOM
ON	-	MOM
ON	ON	ON
ON	ON	MOM
MOM	ON	MOM

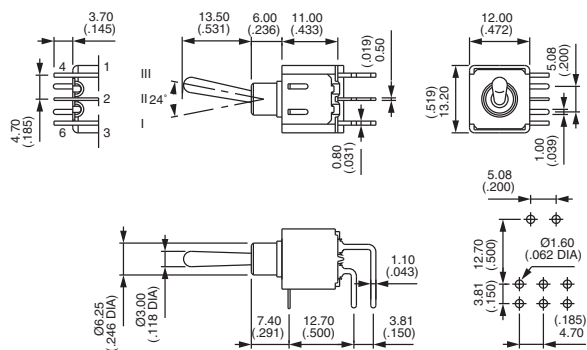

\*Function 4 : SP in DP case - specify CT or TH connections, see end of catalogue.

### Three pole



5256W  
5259W  
5257W  
5258W  
5252W

III	II	I
2-3		1-2
5-6		4-5
8-9		7-8
ON	-	ON
ON	OFF	ON
MOM	OFF	MOM
ON	OFF	MOM
ON	-	MOM

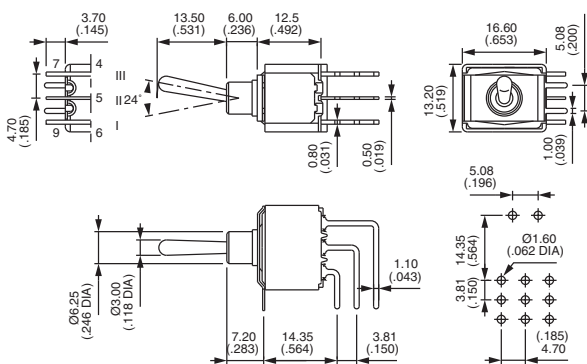



# 5000 series

Toggle switches - plain bushing

Right angle terminals - horizontal : 5400W

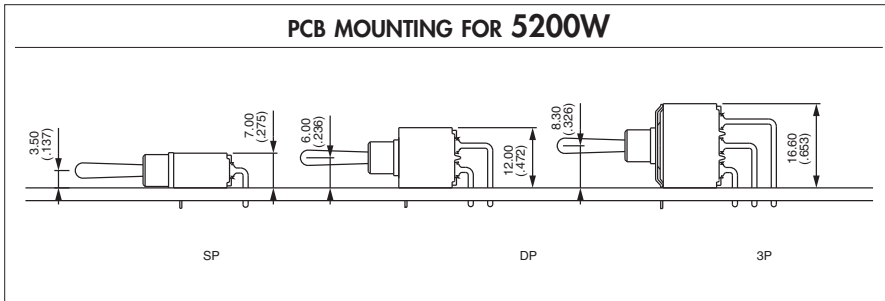

A

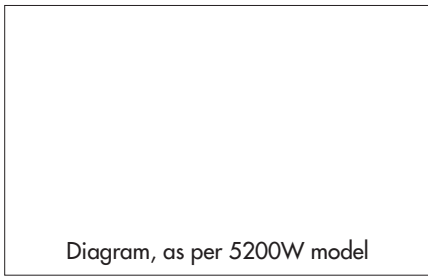

## 5400W models

- Terminal spacing 4 mm (.157)
- 1 and 2 pole configurations

**MODEL STRUCTURE**

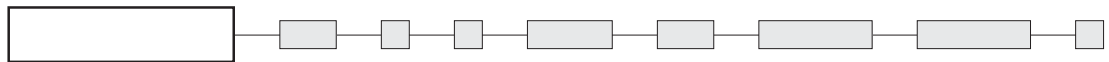

For model structure numbers, refer to 5200W single and double pole and replace 2 with 4.

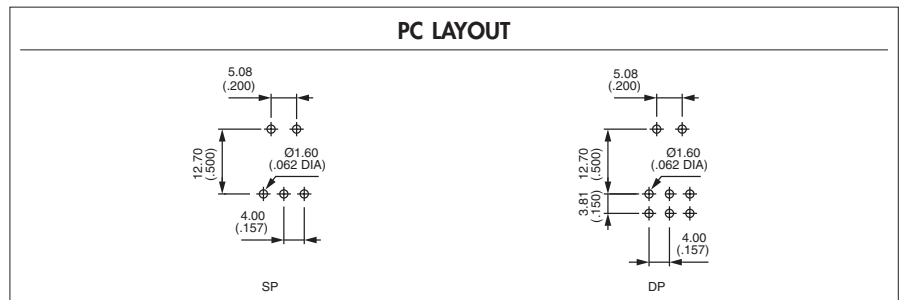

# 5000 series

## Toggle switches - plain bushing

Right angle terminals - vertical : 5200WW



A

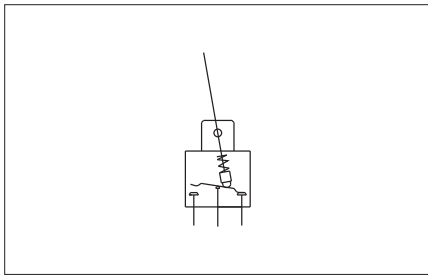

- Pin spacing 3,81 mm (.150)
- 1, 2, 3 and 4 pole configurations

MODEL STRUCTURE

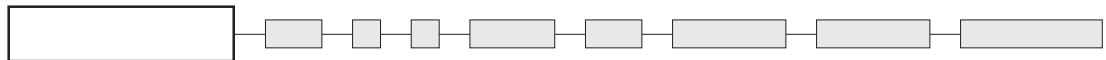

Shown with standard lever

### Single pole



5236WW  
5239WW  
5237WW  
5238WW\*\*  
5232WW\*\*

III	II	I
2-3		1-2
ON	-	ON
ON	OFF	ON
MOM	OFF	MOM
ON	OFF	MOM
ON	-	MOM

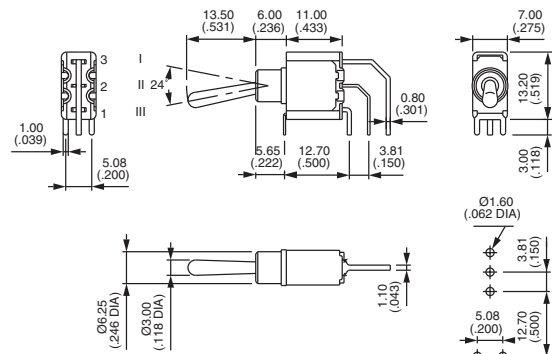

### Double pole



5246WW  
5249WW  
5247WW  
5248WW\*\*  
5242WW\*\*  
5244WW\*  
5244WW 1R\*  
5244WW 2R\*

III	II	I
2-3		1-2
5-6		4-5
ON	-	ON
ON	OFF	ON
MOM	OFF	MOM
ON	OFF	MOM
ON	-	MOM
ON	ON	ON
ON	ON	MOM
MOM	ON	MOM

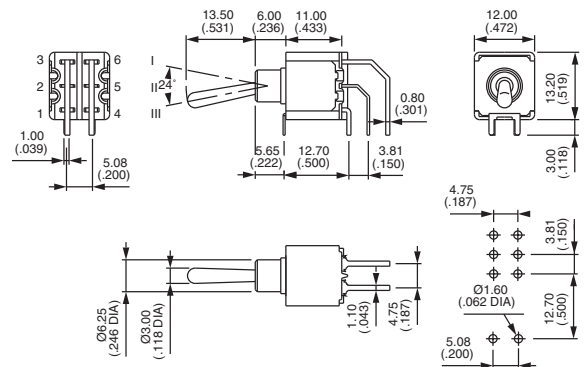

### Three pole



5256WW  
5259WW  
5257WW  
5258WW\*\*  
5252WW\*\*

III	II	I
2-3		1-2
5-6		4-5
8-9		7-8
ON	-	ON
ON	OFF	ON
MOM	OFF	MOM
ON	OFF	MOM
ON	-	MOM

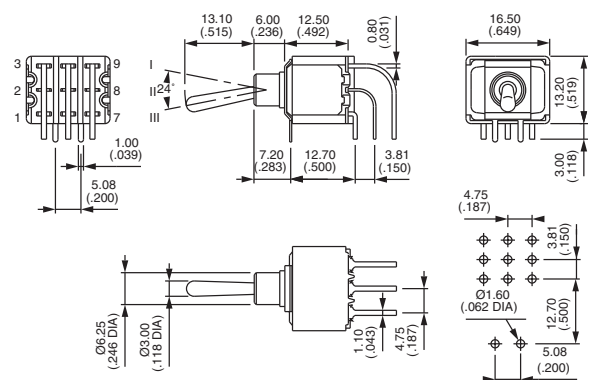

\* and \*\* : see notes next page.



# 5000 series

## Toggle switches - plain bushing

Right angle terminals - vertical : 5200WW - 5400WW

### Four pole



5266WW  
5269WW  
5267WW  
5268WW\*\*  
5262WW\*\*  
5264WW\*  
5264WW 1R\*  
5264WW 2R\*

III	II	I
2-3		1-2
5-6		4-5
8-9		7-8
11-12	10-11	
	ON	ON
	ON OFF	ON
	MOM OFF	MOM
	ON OFF	MOM
	ON	MOM
	ON ON	ON
	ON ON	MOM
	MOM ON	MOM

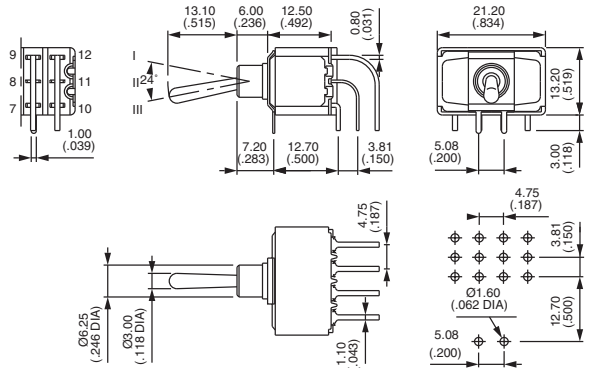

\* Function 4 : SP in DP case, DP in 4P case - specify CT or TH connections, see end of catalogue.  
\*\* Functions 2 and 8 : reversed connection available, consult factory.

### PCB MOUNTING

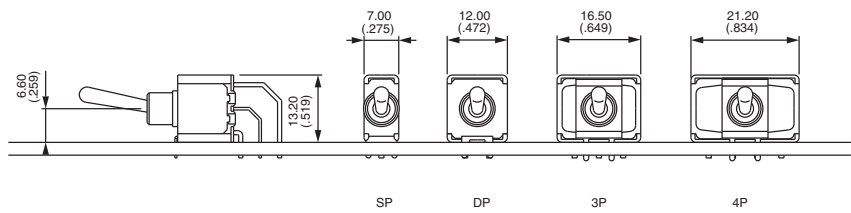

### 5400WW models

- Pin spacing 2,54 mm (.100)
- 1, 2, 3 and 4 pole configurations

Diagram as per 5200WW model

### MODEL STRUCTURE

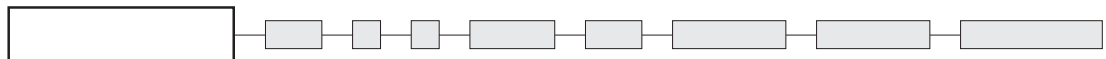

For model structure numbers, refer to **5200WW** models and replace 2 with 4.

### PC LAYOUT

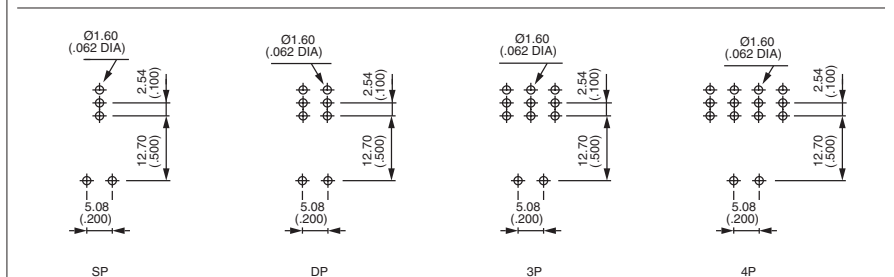

A

# 5000 series

## Toggle switches - plain bushing

Straight PC terminals - bracket mounting : 5200Y



A

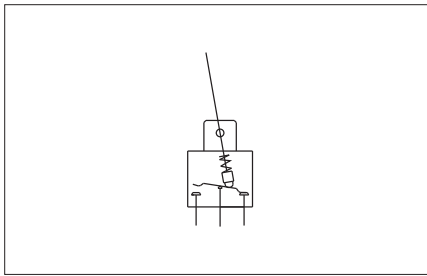

Brackets reduce mechanical stress on solder joints and increase resistance to vibrations.  
Bracket material : tin plated steel.

- Epoxy sealed terminals standard
- 1 and 2 pole configurations

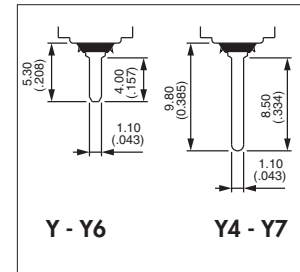

MODEL  
STRUCTURE

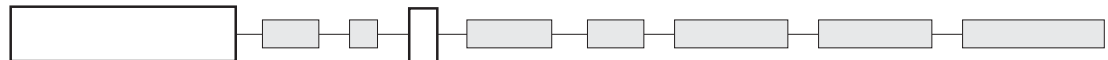

Shown with standard lever

### Short bracket - width 15,75 (.620) - single pole : 5230Y



5236Y B  
5239Y B  
5237Y B  
5238Y B  
5232Y B

III	II	I
2-3		1-2

ON	-	ON
ON	OFF	ON
MOM	OFF	MOM
ON	OFF	MOM
ON	-	MOM

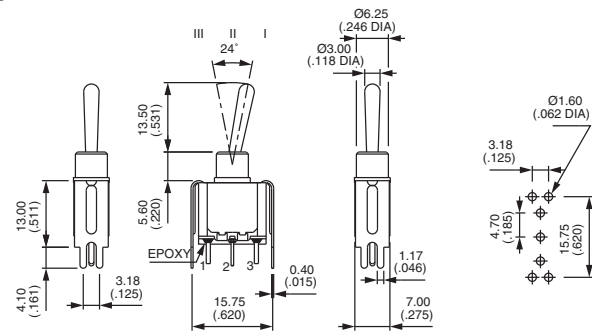

### Short bracket - width 15,75 (.620) - double pole : 5240Y



5246Y B  
5249Y B  
5247Y B  
5248Y B  
5242Y B  
5244Y B\*  
5244Y 1R B\*  
5244Y 2R B\*

III	II	I
2-3		1-2
5-6		4-5

ON	-	ON
ON	OFF	ON
MOM	OFF	MOM
ON	OFF	MOM
ON	-	MOM
ON	ON	ON
ON	ON	MOM
MOM	ON	MOM

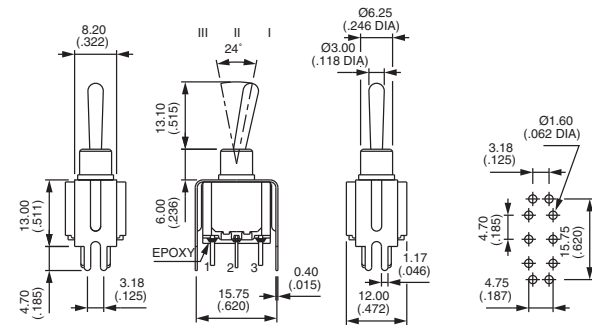

\* Function 4 : SP in DP case - specify CT or TH connections, see end of catalogue.

# 5000 series

## Toggle switches - plain bushing

Straight PC terminals - bracket mounting : 5200Y4 - Y6 - Y7

### Tall bracket - width 15,75 (.620) : 5200Y4



Single pole Double pole

Part Number	Function	III	II	I
5236Y4 B	5246Y4 B	2-3	-	1-2
5239Y4 B	5249Y4 B	5-6	OFF	ON
5237Y4 B	5247Y4 B	MOM	OFF	MOM
5238Y4 B	5248Y4 B	ON	OFF	MOM
5232Y4 B	5242Y4 B	ON	-	MOM
	5244Y4 B*	ON	ON	ON
	5244Y4 1R B*	ON	ON	MOM
	5244Y4 2R B*	MOM	ON	MOM

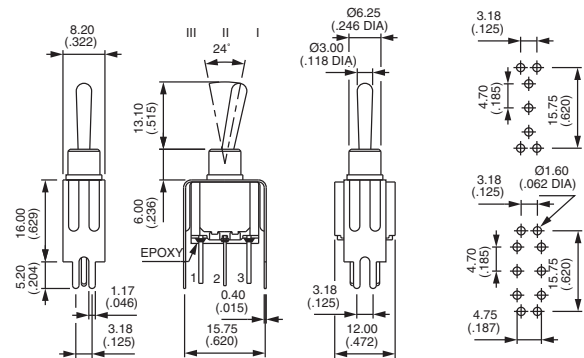

### Short bracket - width 19,05 (.750) : 5200Y6



Single pole Double pole

Part Number	Function	III	II	I
5236Y6 B	5246Y6 B	2-3	-	1-2
5239Y6 B	5249Y6 B	5-6	OFF	ON
5237Y6 B	5247Y6 B	MOM	OFF	MOM
5238Y6 B	5248Y6 B	ON	OFF	MOM
5232Y6 B	5242Y6 B	ON	-	MOM
	5244Y6 B*	ON	ON	ON
	5244Y6 1R B*	ON	ON	MOM
	5244Y6 2R B*	MOM	ON	MOM

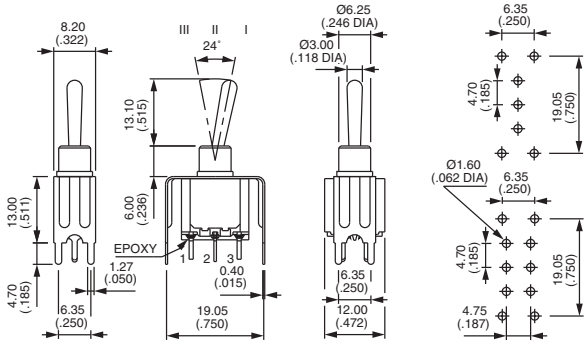

### Tall bracket - width 19,05 (.750) : 5200Y7



Single pole Double pole

Part Number	Function	III	II	I
5236Y7 B	5246Y7 B	2-3	-	1-2
5239Y7 B	5249Y7 B	5-6	OFF	ON
5237Y7 B	5247Y7 B	MOM	OFF	MOM
5238Y7 B	5248Y7 B	ON	OFF	MOM
5232Y7 B	5242Y7 B	ON	-	MOM
	5244Y7 B*	ON	ON	ON
	5244Y7 1R B*	ON	ON	MOM
	5244Y7 2R B*	MOM	ON	MOM

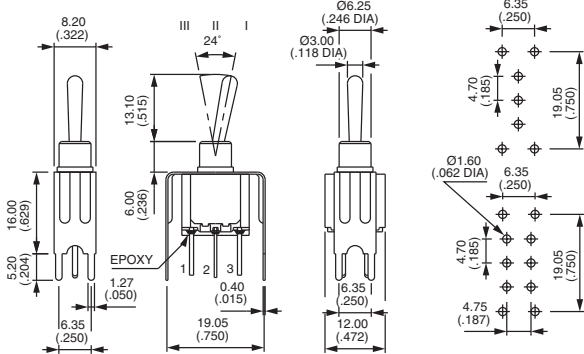

\* Function 4 : SP in DP case - specify CT or TH connections, see end of catalogue.

# 5000 series

## Toggle switches



### CONTACT MATERIALS

UG1006-A

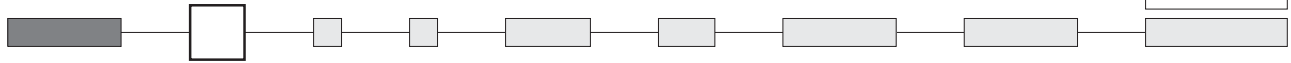

- A Silver
- AD Silver, gold plated
- CD Brass, gold plated

Special contacts for peak currents : see X814, under "Special Options".

### FINISH

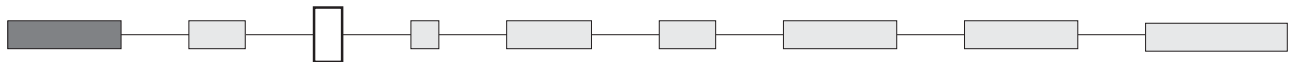

- Blank Bright chrome finish
- G Matt black finish on bushing, actuator and hardware

### SEALING

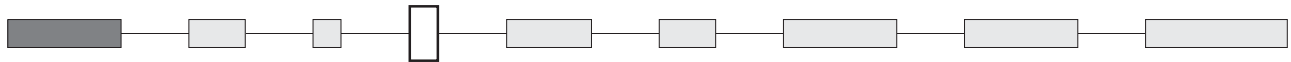

- Blank
  - For 5000 - 5200Z and 5200MIWR models : epoxy sealed terminals standard
  - Other models : no sealing required

B Epoxy sealed terminals

K Front panel sealing by one O-ring and sealing washer. Protects the switch against water and dust. Panel seal withstands 1 bar pressure and remains sealed even when switch is operated.

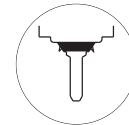

Available on models with  $\varnothing 6,35$  (1/4) or  $11,9$  (15/32) threaded bushing only.  
Not available with levers 8, 9, 12, 22, 23.

KB Combined sealings

- ① O-ring
- ② Sealing washer

K with  $\varnothing 6,35$  (1/4) keyway bushing



Includes washer  
**U360**

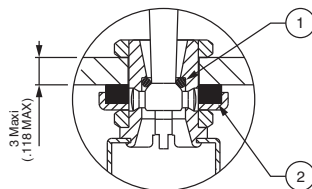

K with  $\varnothing 6,35$  (1/4) flatted bushing



Includes washer  
**U5141**

K with  $\varnothing 11,9$  (15/32) keyway bushing

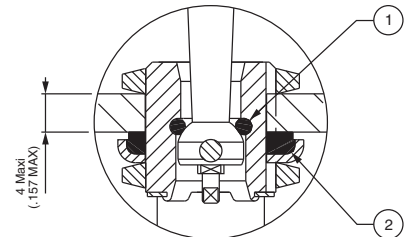

Includes washer  
**U60**

Sealing by two O-rings, see X408 under "Special options".



# 5000 series

## Toggle switches

### FLUORESCENT TIP

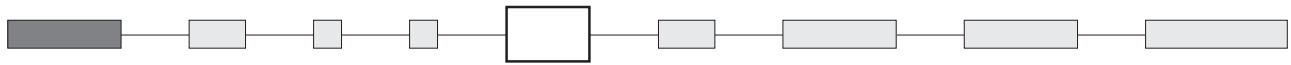

Blank None

**038** White fluorescent tip.  
Becomes luminous when submitted to ultraviolet rays.



Available with matt black finish (option G) only.

Consult factory for levers available with this option.

Standard lever

Locking lever

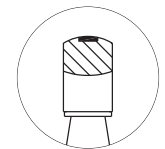
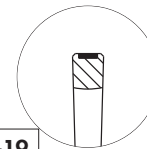

**-19**

Same dimensions as standard actuator below.

**A**

### ACTUATORS



Dash compulsory before lever code.

Levers for threaded bushing models  $\varnothing 6,35$  (1/4) or  $\varnothing 6$  (.236)

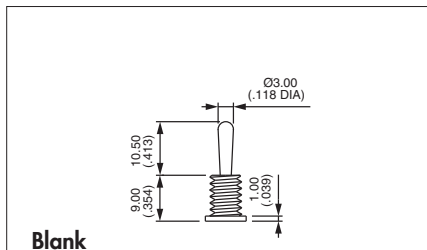

**Blank**  
Standard

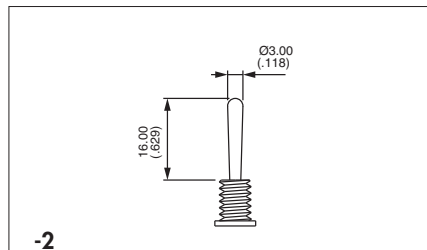

**-2**

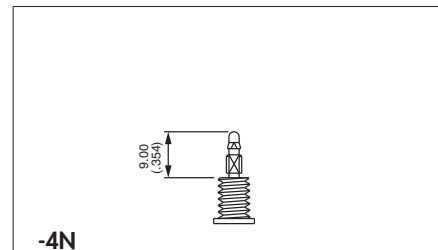

**-4N**

For use with paddles only

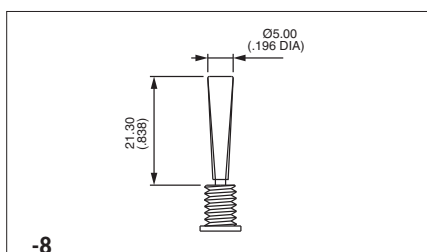

**-8**

Not available with sealing options K or X408

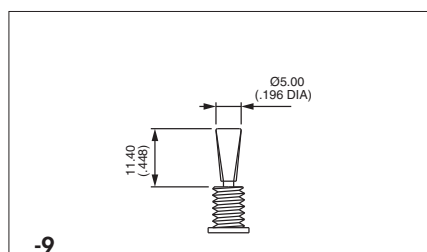

**-9**

Not available with sealing options K or X408

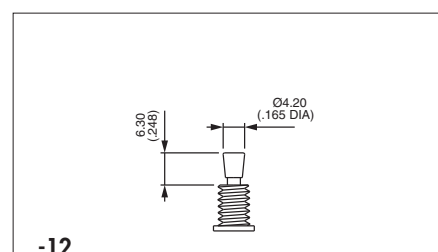

**-12**

Not available with sealing options K or X408

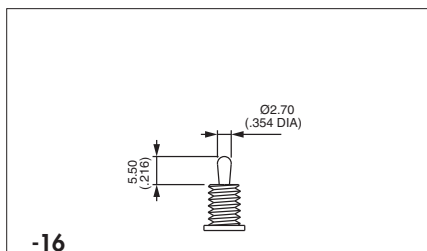

**-16**

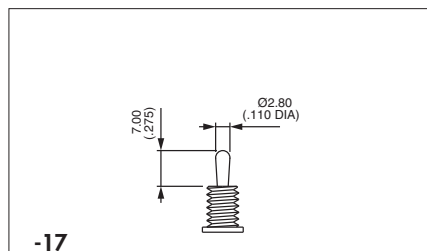

**-17**

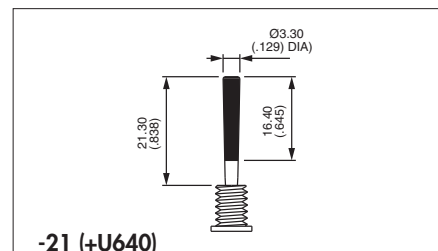

**-21 (+U640)**

U640 to be placed in last box of ordering format. Replace 0 by colour code.



# 5000 series

## Toggle switches



A

### ACTUATORS (continued)

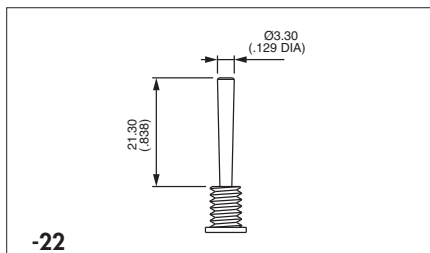

-22

Not available with sealing options K or X408

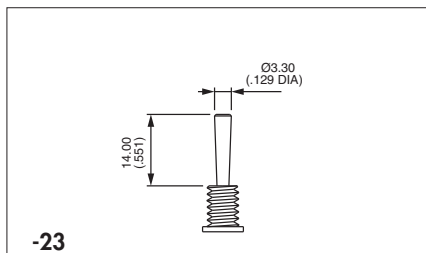

-23

Not available with sealing options K or X408

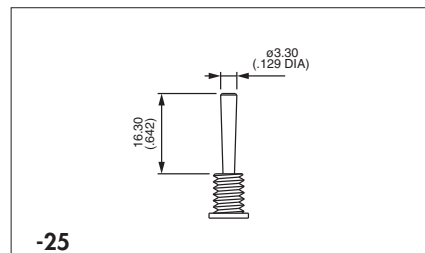

-25

Not available with sealing options K or X408

### Levers for threaded bushing models Ø 11,9 (15/32) : 5600M

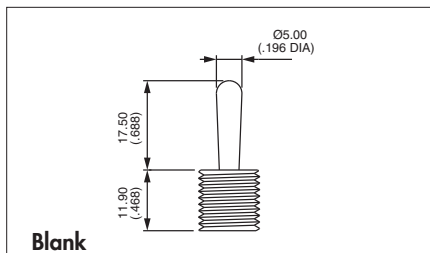

Blank

Standard

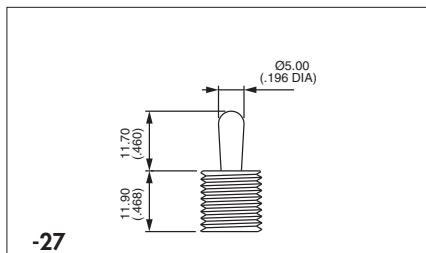

-27

### Locking levers

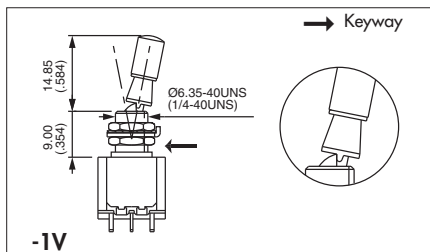

-1V

1 locked position (function 6)

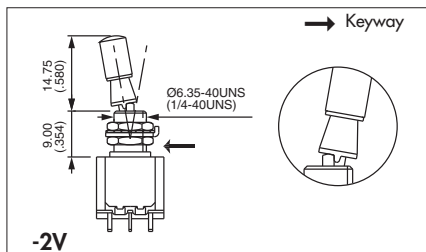

-2V

2 locked positions (function 6)

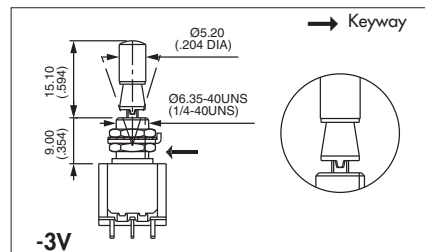

-3V

3 locked positions (functions 9 and 4)

Consult factory for other locking lever options.



Available with Ø 6,35 mm (1/4) threaded bushing models only.  
For plain bushing models, see X386 or X916 under "Special options" on the following pages.



# 5000 series

## Toggle switches

A

### ACTUATORS (continued)

For plain bushing models : W - WW and Y

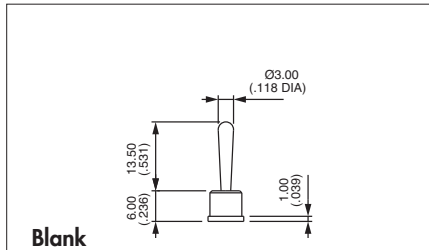

**Blank**  
Standard

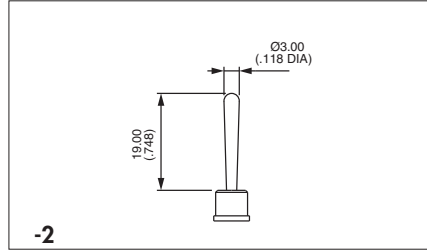

**-2**

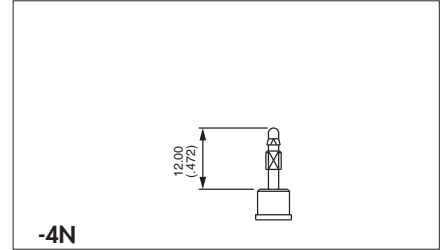

**-4N**  
For use with paddles only

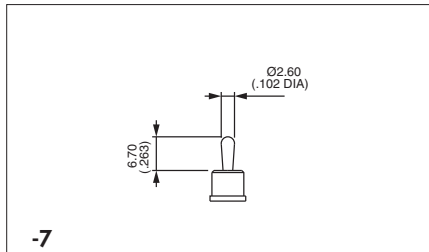

**-7**

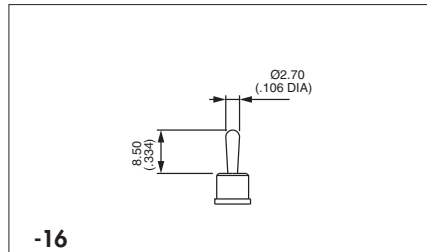

**-16**

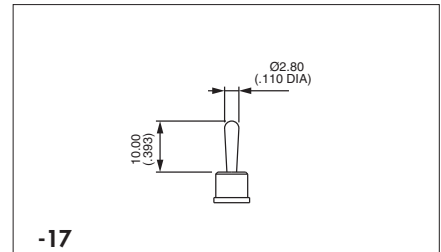

**-17**

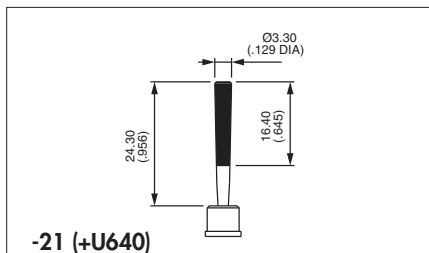

**-21 (+U640)**  
U640 to be placed in last box of ordering format. Replace 0 by colour code.

Actuator colours	
Replace "0" by number	
1	blue
1/4	dark blue
2	black
3	green
4	grey
5	yellow
6	red
7	ivory
7/1	white
9	orange



#### LEVER LENGTH

With bracket or mounting plate lever length will be reduced by 0,4 mm (.015) as a rule. Please refer to switch technical drawings in "Model Structure" pages for details.

# 5000 series

## Toggle switches



### SPECIAL OPTIONS

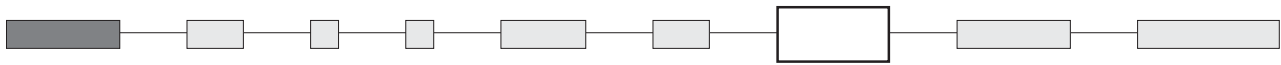

**Blank** No special requirement

**X408** Front panel sealing by two O-rings. Flatted bushing for precise orientation. Protects the switch against water and dust. Panel seal withstands 1 bar pressure and remains sealed even when switch is operated. Includes sealed terminals (option B).



Available only on models with threaded bushing except 5600M.  
Not available with levers 8, 9, 12, 22, 23.

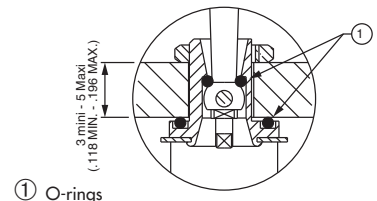

① O-rings

**X404** Horizontal right angle with reduced overall dimensions (shown with lever -16)

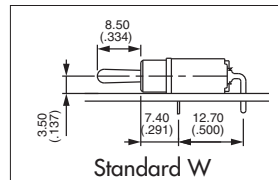

Standard W

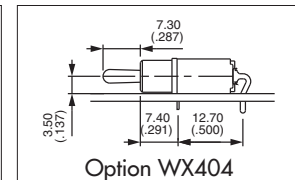

Option WX404



	III	II	I
	2-3		1-2
	5-6		4-5
Single pole			
5236W X404	5246W X404	ON	- ON
5239W X404	5249W X404	ON	OFF ON
5237W X404	5247W X404	MOM	OFF MOM
5238W X404	5248W X404	ON	OFF MOM
5232W X404	5242W X404	ON	- MOM
	5244W X404*	ON	ON ON
	5244W1R X404*	ON	ON MOM
	5244W2R X404*	MOM	ON MOM

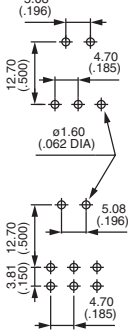
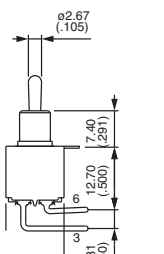
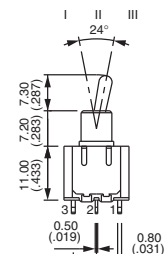
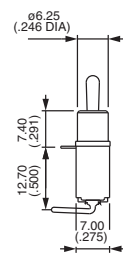

\* Function 4 : SP in DP case - specify CT or TH connections, see end of catalogue.

Lever lengths for WX404 (also available with X445 option)

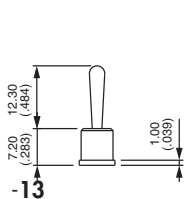

-13

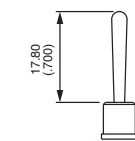

-2

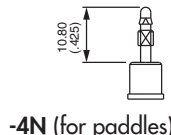

-4N (for paddles)

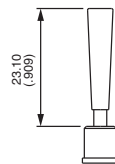

-8

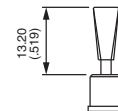

-9

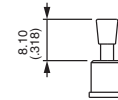

-12

Note : levers -8, -9 and -12 not available with function 2 (ON-MOM)

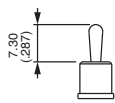

-16

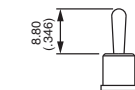

-17

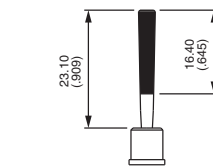

-21 (+U640)\*

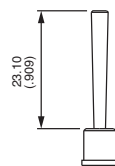

-22

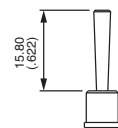

-23

\* U640 to be placed in last box of ordering format. Replace 0 by colour code.

Insulating caps and paddles for X404 :

Insulating cap U1710 available with lever style 16.

Paddles U240N, U290N and U390N available with lever style 4N. See details on next pages.



# 5000 series

## Toggle switches

### SPECIAL OPTIONS (continued)



With options X372, X386, X442 and X445, the lever lengths indicated on previous pages will be modified.

**X371** Plain bushing  $\varnothing$  6,25 mm (.246) (instead of standard threaded bushing).

**X372** Threaded bushing  $\varnothing$  6,35 (1/4). **Height 7 mm (.274).**

**X386** Threaded bushing  $\varnothing$  6,35 mm (1/4) to replace plain bushing on models W - WW and Y.

**X442** Threaded bushing  $\varnothing$  6,35 mm (1/4) - **Height 9,9 mm (.389).**

**X445** Plain bushing. **Height 7,2 mm (.283)** - for W, WW and Y models. Available with the same levers, insulating cap and paddles as X404.

**X601** **Silver plated brass contacts.**  
Current/voltage rating for an electrical life of 20.000 cycles :  
0,2A 250VAC - 0,4A 125VAC - 0,5A 30VDC.  
Minimum quantity : 5.000 pieces per model and shipment.

**X681** **Satin chrome** actuator

**X814** **Switches for peak currents**

Peak current up to 120A (1 ms) 60VDC - single/double pole



Single pole		
<b>5636A X814</b>	ON	- ON
Double pole		
<b>5646A X814</b>	ON	- ON

- Contacts : silver/nickel alloy (AgNi)
- Max. current/voltage rating :  
2/120A (1 ms) 60VDC - 10.000 cycles  
3/40A 125VAC - 250VAC - 10.000 cycles
- Further specifications and dimensions : see 5600 series.
- General information on peak currents : see end of catalogue.

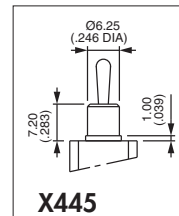
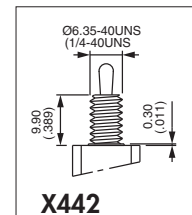
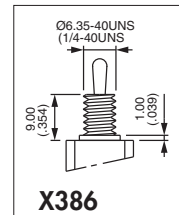
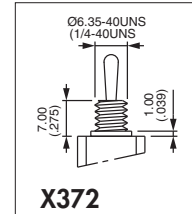
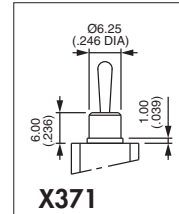

**X902** Plain bushing  $\varnothing$  6,25 mm (.246) - **Height 9 mm (.354).**

**X916** Locking lever on model with plain bushing.

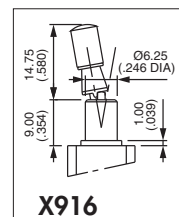

# 5000 series

## Toggle switches



### AGENCY APPROVALS

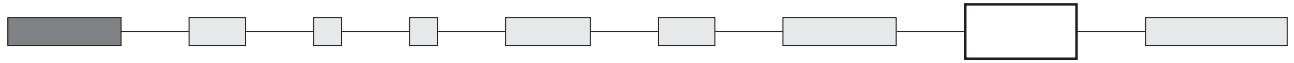

UL  
CSA  
CECC

All standard models, except 5200MIWR

Standard models 5600 - 5200

**Availability** : consult factory for details of approved combinations or options.

**Marking** : to order switches marked UL, CSA or CECC, complete above box with desired approvals, in this order & without space (ex. : ULCSACECC). Blank : no agency approval required.

**VDE (with UL & CSA)** Refer to 55000 series on the following pages.

Preferential lists : see specifications.

### INSULATING CAPS AND PADDLES

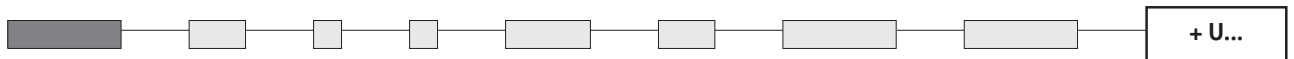

#### Insulating caps

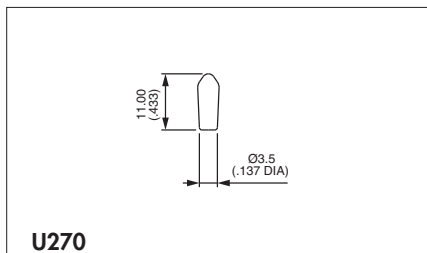

**U270**

For lever 13 and threaded bushing only

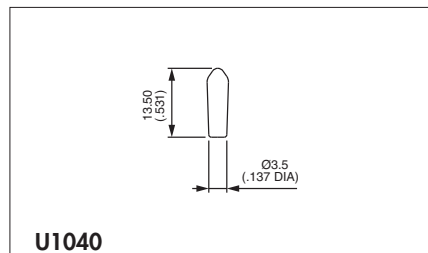

**U1040**

For lever 13 and plain bushing only

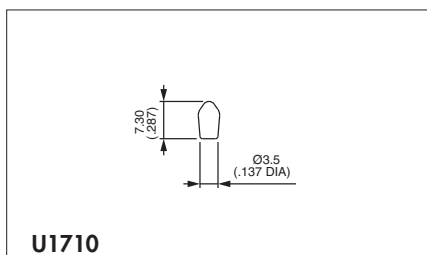

**U1710**

For lever 17 and threaded bushing  
For lever 7 and plain bushing

Cap colours	
Replace last "0" by number	
1	blue
1/4	dark blue
2	black
3	green
4	grey
5	yellow
6	red
7/1	white
9	orange



Insulating caps are not available in ivory colour.



# 5000 series

## Toggle switches

### INSULATED CAPS AND PADDLES (continued)

#### Paddles

For use with lever 4N only. Shown with standard threaded bushing. Order separately.

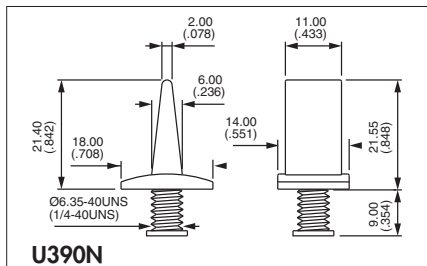
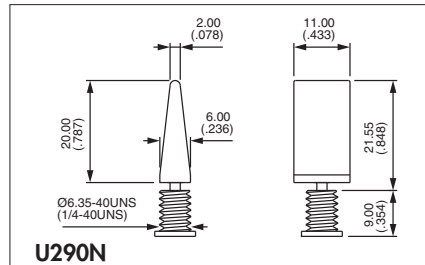
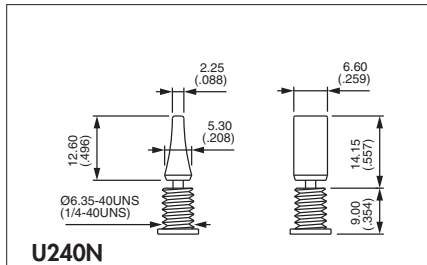

#### Paddle colours

Replace last "0" by number

- 1 blue
- 1/4 dark blue
- 2 black
- 3 green
- 4 grey
- 5 yellow
- 6 red
- 7 ivory
- 7/1 white
- 9 orange

A