

Asymmetrical - Bridge Trench + Field Stop IGBT® Power Module

$V_{CES} = 600V$
 $I_C = 50A @ T_c = 80^\circ C$

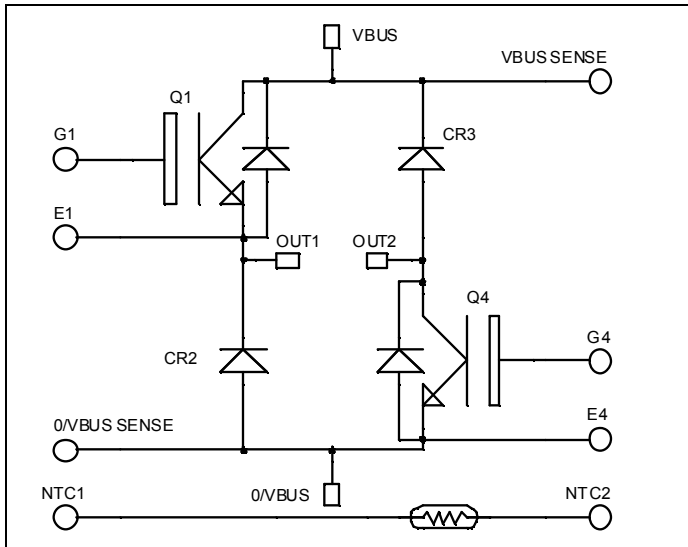

Application

- Welding converters
- Switched Mode Power Supplies
- Uninterruptible Power Supplies
- Motor control

Features

- Trench + Field Stop IGBT® Technology
 - Low voltage drop
 - Low tail current
 - Switching frequency up to 20 kHz
 - Soft recovery parallel diodes
 - Low diode VF
 - Low leakage current
 - Avalanche energy rated
 - RBSOA and SCSOA rated
- Kelvin emitter for easy drive
- Kelvin emitter for easy drive
- Very low stray inductance
 - Symmetrical design
 - Lead frames for power connections
- Internal thermistor for temperature monitoring
- High level of integration

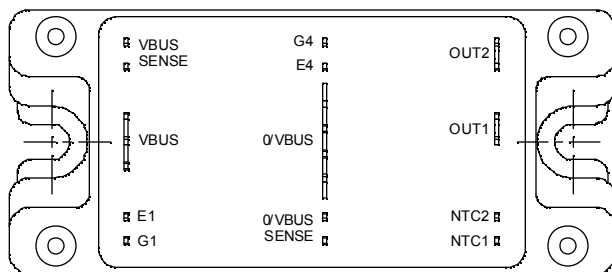

Benefits

- Stable temperature behavior
- Very rugged
- Solderable terminals for easy PCB mounting
- Direct mounting to heatsink (isolated package)
- Low junction to case thermal resistance
- Easy paralleling due to positive TC of VCESat
- Low profile
- RoHS Compliant

Absolute maximum ratings

Symbol	Parameter	Max ratings	Unit
V_{CES}	Collector - Emitter Breakdown Voltage	600	V
I_C	Continuous Collector Current	$T_C = 25^\circ C$	80
		$T_C = 80^\circ C$	50
I_{CM}	Pulsed Collector Current	$T_C = 25^\circ C$	100
V_{GE}	Gate - Emitter Voltage	± 20	V
P_D	Maximum Power Dissipation	$T_C = 25^\circ C$	176
RBSOA	Reverse Bias Safe Operating Area	$T_J = 150^\circ C$	100A @ 550V

CAUTION: These Devices are sensitive to Electrostatic Discharge. Proper Handling Procedures Should Be Followed. See application note APT0502 on www.microsemi.com

All ratings @ $T_j = 25^\circ\text{C}$ unless otherwise specified

Electrical Characteristics

Symbol	Characteristic	Test Conditions	Min	Typ	Max	Unit
I_{CES}	Zero Gate Voltage Collector Current	$V_{GE} = 0\text{V}$, $V_{CE} = 600\text{V}$			250	μA
$V_{CE(sat)}$	Collector Emitter Saturation Voltage	$V_{GE} = 15\text{V}$ $I_C = 50\text{A}$	$T_j = 25^\circ\text{C}$	1.5	1.9	V
			$T_j = 150^\circ\text{C}$	1.7		
$V_{GE(th)}$	Gate Threshold Voltage	$V_{GE} = V_{CE}$, $I_C = 600\mu\text{A}$	5.0	5.8	6.5	V
I_{GES}	Gate – Emitter Leakage Current	$V_{GE} = 20\text{V}$, $V_{CE} = 0\text{V}$			600	nA

Dynamic Characteristics

Symbol	Characteristic	Test Conditions	Min	Typ	Max	Unit
C_{ies}	Input Capacitance	$V_{GE} = 0\text{V}$		3150		pF
C_{oes}	Output Capacitance	$V_{CE} = 25\text{V}$		200		
C_{res}	Reverse Transfer Capacitance	$f = 1\text{MHz}$		95		
$T_{d(on)}$	Turn-on Delay Time	Inductive Switching (25°C) $V_{GE} = \pm 15\text{V}$ $V_{Bus} = 300\text{V}$ $I_C = 50\text{A}$ $R_G = 8.2\Omega$		110		ns
T_r	Rise Time			45		
$T_{d(off)}$	Turn-off Delay Time			200		
T_f	Fall Time			40		
$T_{d(on)}$	Turn-on Delay Time	Inductive Switching (150°C) $V_{GE} = \pm 15\text{V}$ $V_{Bus} = 300\text{V}$ $I_C = 50\text{A}$ $R_G = 8.2\Omega$		120		ns
T_r	Rise Time			50		
$T_{d(off)}$	Turn-off Delay Time			250		
T_f	Fall Time			60		
E_{on}	Turn-on Switching Energy	$V_{GE} = \pm 15\text{V}$ $V_{Bus} = 300\text{V}$ $I_C = 50\text{A}$	$T_j = 25^\circ\text{C}$	0.3		mJ
			$T_j = 150^\circ\text{C}$	0.43		
E_{off}	Turn-off Switching Energy	$R_G = 8.2\Omega$	$T_j = 25^\circ\text{C}$	1.35		mJ
			$T_j = 150^\circ\text{C}$	1.75		

Diode ratings and characteristics

Symbol	Characteristic	Test Conditions	Min	Typ	Max	Unit
V_{RRM}	Maximum Peak Repetitive Reverse Voltage		600			V
I_{RM}	Maximum Reverse Leakage Current	$V_R = 600\text{V}$	$T_j = 25^\circ\text{C}$		250	μA
			$T_j = 150^\circ\text{C}$		500	
I_F	DC Forward Current		$T_c = 80^\circ\text{C}$	50		A
V_F	Diode Forward Voltage	$I_F = 50\text{A}$ $V_{GE} = 0\text{V}$	$T_j = 25^\circ\text{C}$	1.6	2	V
			$T_j = 150^\circ\text{C}$	1.5		
t_{rr}	Reverse Recovery Time	$I_F = 50\text{A}$ $V_R = 300\text{V}$ $di/dt = 1800\text{A}/\mu\text{s}$	$T_j = 25^\circ\text{C}$	100		ns
			$T_j = 150^\circ\text{C}$	150		
Q_{rr}	Reverse Recovery Charge		$T_j = 25^\circ\text{C}$	2.6		μC
			$T_j = 150^\circ\text{C}$	5.4		
E_r	Reverse Recovery Energy		$T_j = 25^\circ\text{C}$	0.6		mJ
			$T_j = 150^\circ\text{C}$	1.2		

Temperature sensor NTC (see application note APT0406 on www.microsemi.com for more information).

Symbol	Characteristic	Min	Typ	Max	Unit
R ₂₅	Resistance @ 25°C		50		kΩ
B _{25/85}	T ₂₅ = 298.15 K		3952		K

$$R_T = \frac{R_{25}}{\exp\left[B_{25/85}\left(\frac{1}{T_{25}} - \frac{1}{T}\right)\right]}$$

T: Thermistor temperature
 R_T: Thermistor value at T

Thermal and package characteristics

Symbol	Characteristic	Min	Typ	Max	Unit	
R _{thJC}	Junction to Case Thermal Resistance	IGBT		0.85	°C/W	
		Diode		1.42		
V _{ISOL}	RMS Isolation Voltage, any terminal to case t=1 min, I _{isol} <1mA, 50/60Hz	2500			V	
T _J	Operating junction temperature range	-40		175	°C	
T _{STG}	Storage Temperature Range	-40		125		
T _C	Operating Case Temperature	-40		100		
Torque	Mounting torque	To heatsink	M5	2.5	4.7	N.m
Wt	Package Weight				160	g

SP4 Package outline (dimensions in mm)

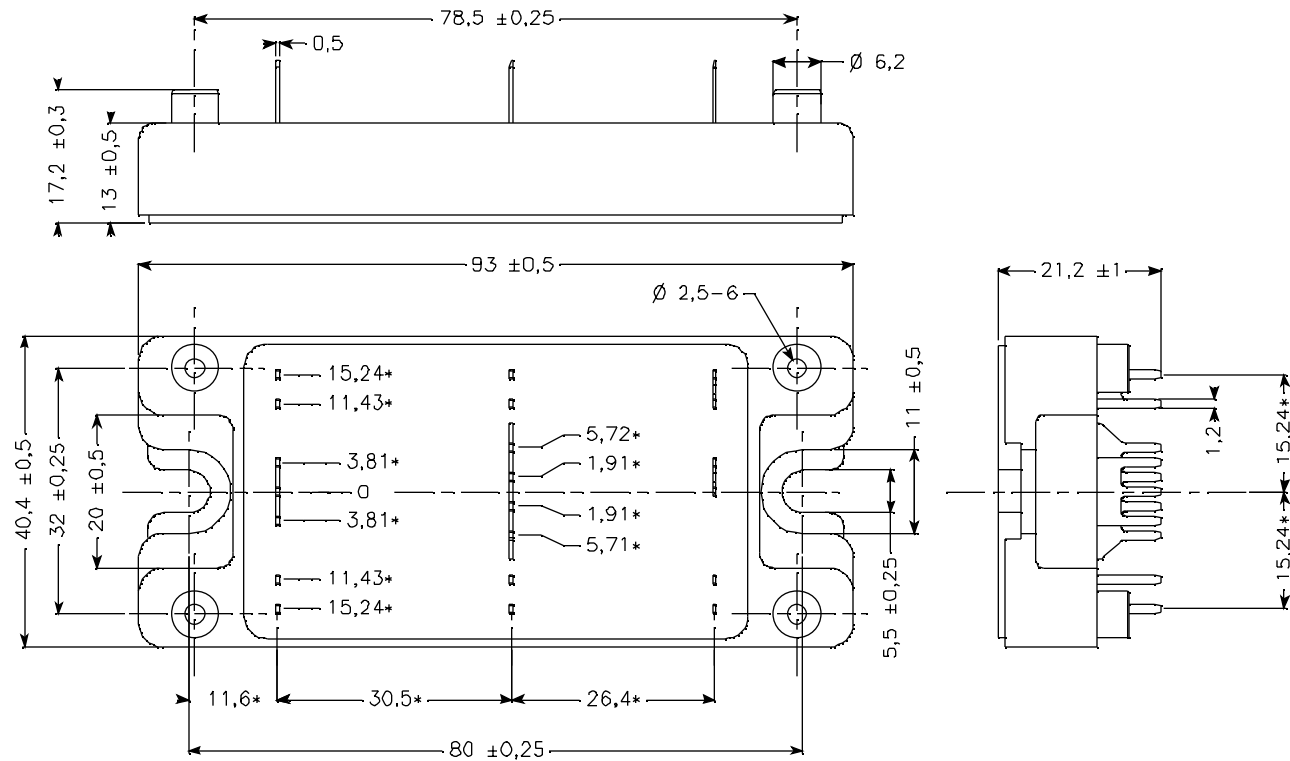

ALL DIMENSIONS MARKED "*" ARE TOLERANCED AS: $\text{M} \pm 0.1$

See application note APT0501 - Mounting Instructions for SP4 Power Modules on www.microsemi.com

Typical Performance Curve

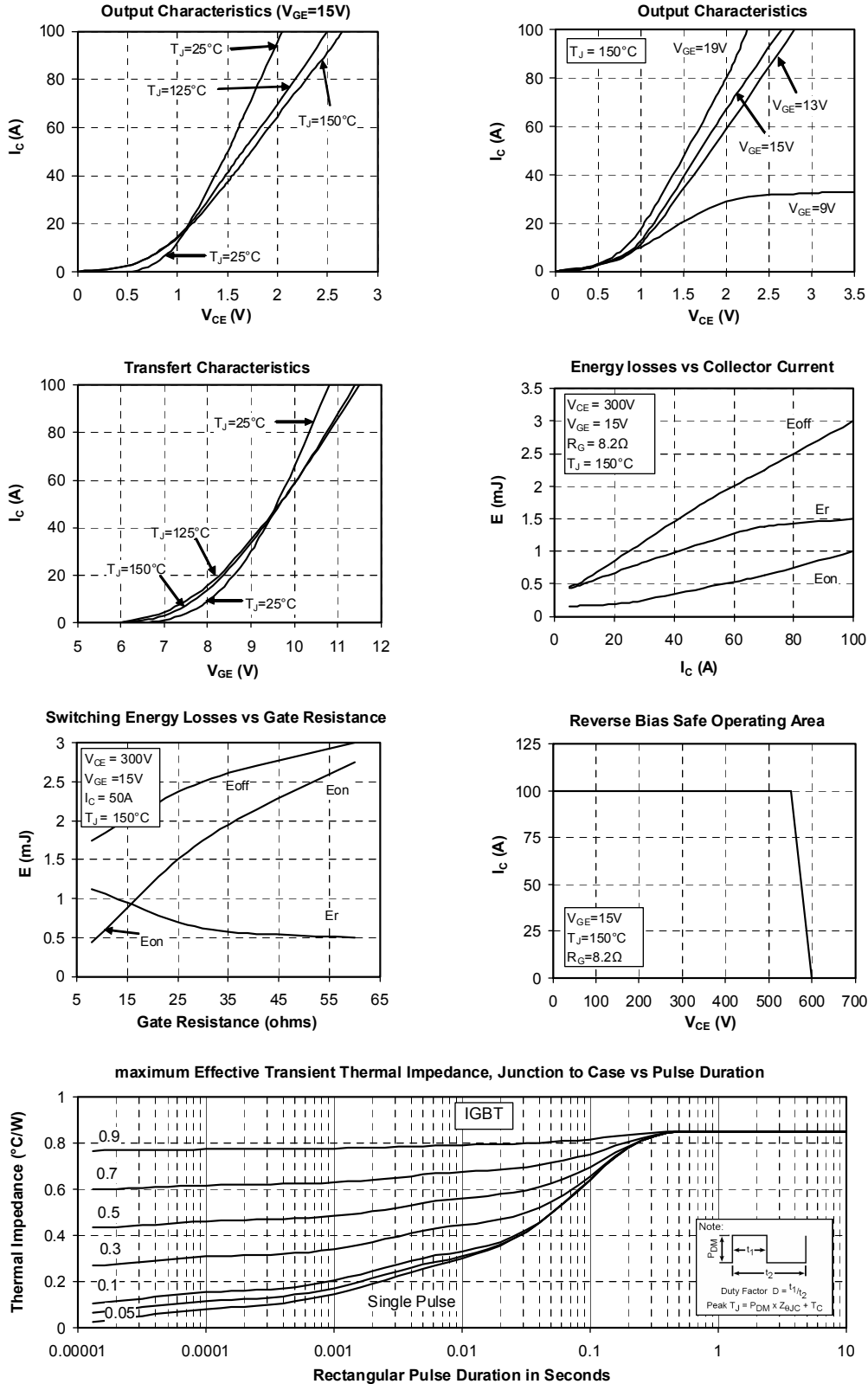

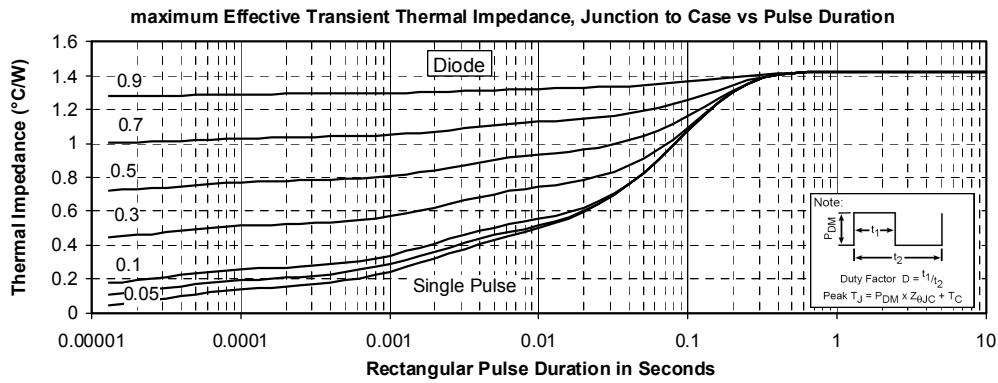
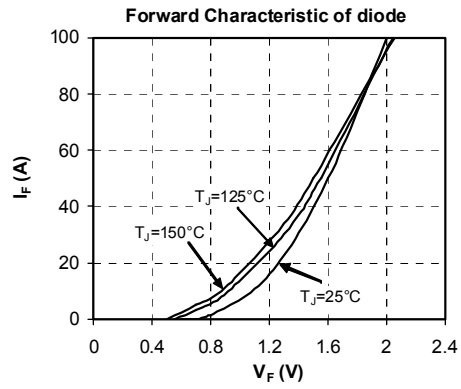
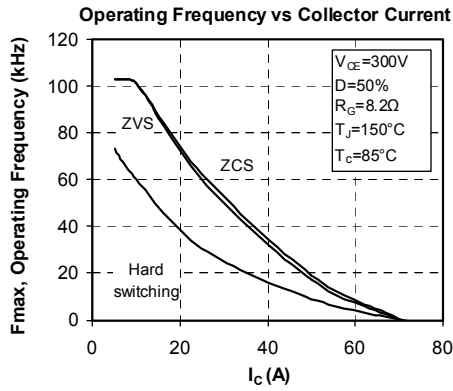

Microsemi reserves the right to change, without notice, the specifications and information contained herein

Microsemi's products are covered by one or more of U.S. patents 4,895,810 5,045,903 5,089,434 5,182,234 5,019,522 5,262,336 6,503,786 5,256,583 4,748,103 5,283,202 5,231,474 5,434,095 5,528,058 and foreign patents. U.S. and Foreign patents pending. All Rights Reserved.