

LCS Series Subminiature Sealed Snap-acting Switches

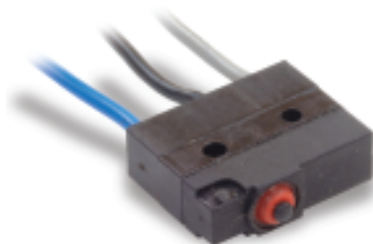

Features/Benefits



- Compact design
- Long life and high electrical capacity
- Quick connect, solder terminals, PC terminals, wire leads
- Wide variety of actuator styles
- RoHS compatible, RoHS compliant
- IP67

Typical Applications

- Motorized equipment
- Sump pump
- Thermostatic controls
- Computers
- Air conditioners



Specifications

CONTACT RATING: 6 AMP, 125/250 V AC  and
5 AMP, 125/250 V AC 
0.1 AMP, 125/250 V AC

ELECTRICAL LIFE: 10,000 cycles

INSULATION RESISTANCE: 100 M ohm min.

DIELECTRIC STRENGTH: 1,000 VAC

OPERATING TEMPERATURE: -40°C to +125°C without wire
-40°C to +85°C with wires

OPERATING FORCE: (see ACTUATOR'S option sections).

MOUNTING: 2-56 screws, torque 2.3 in/lbs max.

Materials

SWITCH HOUSING: Thermoplastic polyester or high temperature thermoplastic (PTS) (UL 94V-0).

ACTUATOR BUTTON: Thermoplastic polyester.

SPRING: Copper alloy.

PIVOT: Copper alloy.

MOVABLE CONTACTS: Silver nickel

STATIONARY CONTACTS: Silver nickel on copper alloy.

TERMINALS: Copper alloy.

ACTUATOR LEVEL: Stainless steel.



NOTE: Specifications and materials listed above are for switches with standard options. For information on specific and custom switches, consult Customer Service center.

Build-A-Switch

To order, simply select desired option from each category and place in the appropriate box. Available options are shown and described on pages J-27 thru J-29. For additional options not shown in catalog, consult Customer Service Center.

Series
LCS

Contact Rating

05 5 AMP, 125/250 V AC 
6 AMP, 125/250 V AC 
01 0.1 AMP, 125/250 V AC

Operating Force

1 150 grams
2 203 grams

Actuator

P00 Pin plunger
T00 0.45 mm short lever
T05 5.05 mm short lever
T07 7.05 mm short lever
T13 13.15 mm lever
T19 20.95 mm lever
T28 28.35 mm lever
T43 43.55 mm lever
S26 6.25 mm simulated lever
A05 4.85 mm lever roller

Terminations

S Solder
Q 0.110 Quick Connect
P PC Thru Hole
W Wire leads potted
Z Wire leads non-potted

Wire Type AWG

20 20 AWG
22 22 AWG
24 24 AWG
26 26 AWG
28 28 AWG
30 30 AWG

Wire UL # (when required)

A UL1007
B UL1015
C UL1430
D UL1061
E UL1330

Circuitry

C SPDT
W SPST N.C.
Y SPST N.O.

Wire Side (when required)

A Wire out the bottom
B Wire out the right side
C Wire out the left side
D None



Dimensions are shown: mm
Specifications and dimensions subject to change

LCS Series Subminiature Sealed Snap-acting Switches

SERIES

LCS

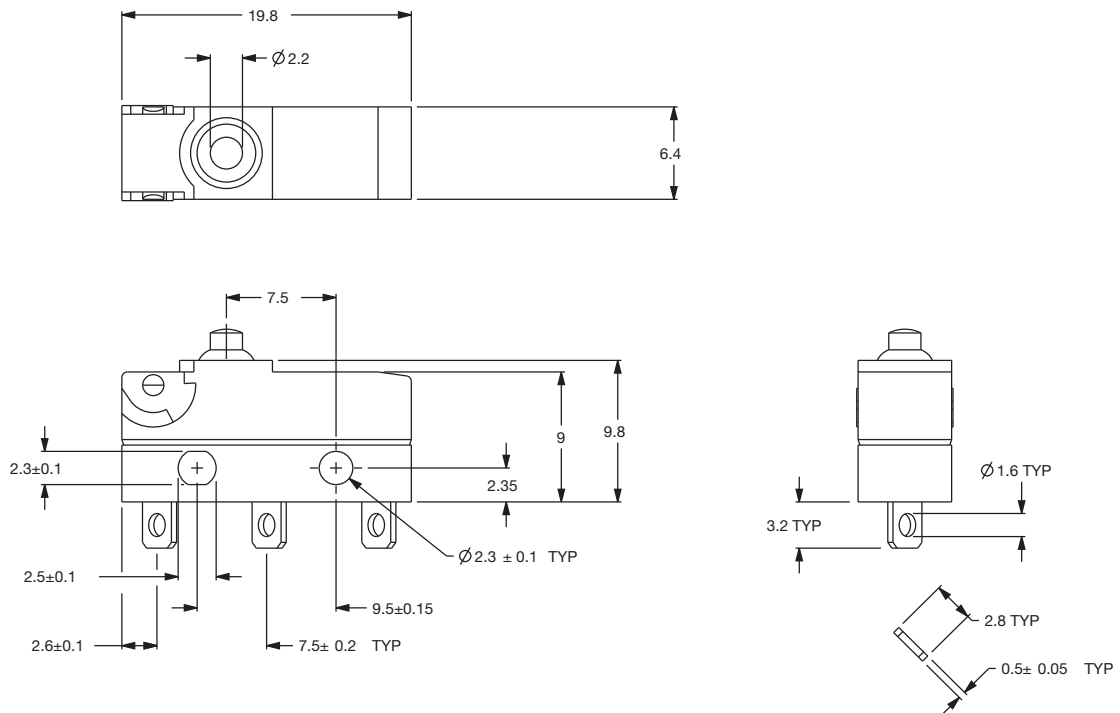

ELECTRICAL RATING

RoHS COMPLIANT *	RoHS COMPATIBLE *	OPTION CODE	ELECTRICAL RATING
YES	YES	05	5 AMP, 125/250 V AC 6 AMP, 125/250 V AC
YES	YES	01	0.1 AMP, 125/250 V AC

OPERATING FORCE

OPTION CODE	OPERATING FORCES (grams)
1	150 g. max.
2	203 g. max.

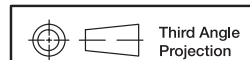

Third Angle Projection
Dimensions are shown: mm
Specifications and dimensions subject to change

www.ck-components.com



LCS Series Subminiature Sealed Snap-acting Switches

TERMINATIONS

S SOLDER

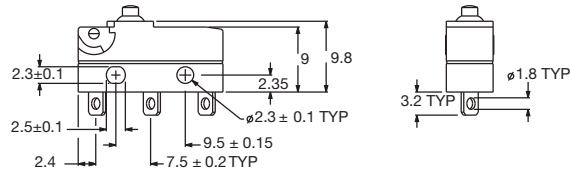

Q QUICK CONNECT .110 QC

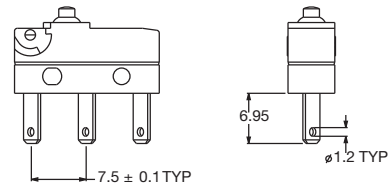

P PC THRU HOLE

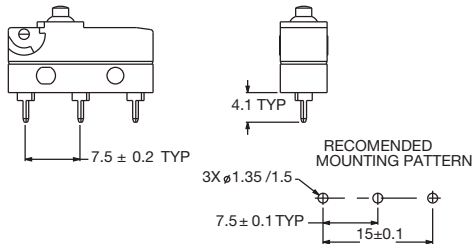

Z or W "A" WIRE ORIENTATION

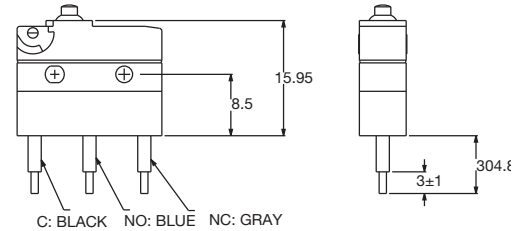

Z or W "B" WIRE ORIENTATION
"Y" OR "W" CIRCUITRY

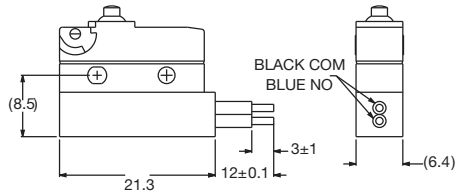

Z or W "C" WIRE ORIENTATION
"Y" OR "W" CIRCUITRY

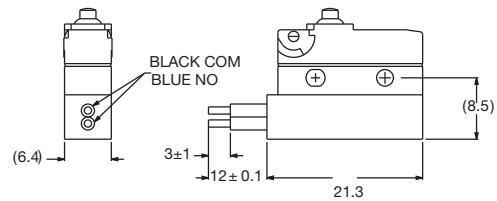

Z or W "B" WIRE ORIENTATION
"C" CIRCUITRY

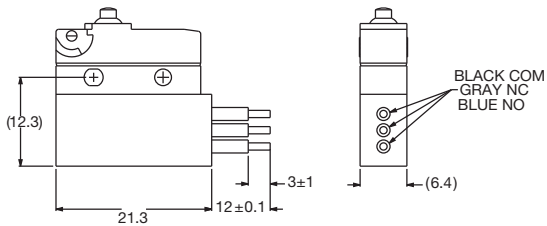

Z or W "C" WIRE ORIENTATION
"C" CIRCUITRY

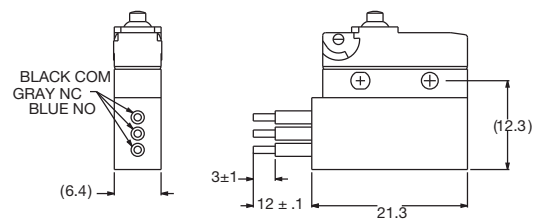

CIRCUITRY

- C** SPDT (Single Pole, Double Throw)
- W** SPST N.C. (Single Pole, Single Throw, Normally Closed)
- Y** SPST N.O. (Single Pole, Single Throw, Normally Open)

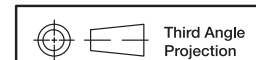

Third Angle
Projection

Dimensions are shown: mm
Specifications and dimensions subject to change



Snap-acting