

Patent Pending

Features/Benefits

- **Process compatible**—internal o-ring and epoxy base seal
- **Thru-hole and surface mount models**
- **Reliable contact design ensures long electrical life**
- **Robust actuator for easy actuation**

Typical Applications

- **Computer peripherals & network products**
- **Test & measurement equipment**
- **Telephone & cable modems**

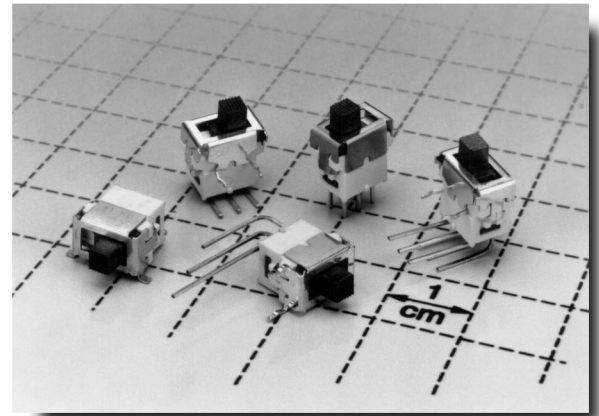

How To Order

Complete part numbers for ES Series Sealed Tiny Slide Switches are shown on pages E-3 thru E-6. These unique tiny slide switches are process compatible. An internal o-ring and epoxy base seal protects the switch from wave and reflow soldering, as well as cleaning processes.

Specifications

CONTACT RATING: 0.4 VA max. @ 20 V AC or DC max.

MECHANICAL & ELECTRICAL LIFE: 40,000 make-and-break cycles at full load.

CONTACT RESISTANCE: 50 milliohms max. initial @ 2-4 V DC, 100 mA.

INSULATION RESISTANCE: 10^9 ohms min.

DIELECTRIC STRENGTH: 500 V RMS min.

OPERATING TEMPERATURE: -30°C to 85°C .

SOLDERABILITY: Per MIL-STD-202F method 208D, or EIA RS-186E method 9.

DEGREE OF PROTECTION: IP57; Protection against harmful dust deposit, full-scale voltage protection, temporary immersion.

ESD ENDURANCE: 8kv min. (EIA 545).

PACKAGING: Thru-hole switches supplied in anti-static trays. Surface mount switches available in tape and reel packaging, see page L-39 for drawings and reel information.

Materials

HOUSING & BASE: Nylon (UL 94V-0).

ACTUATOR: LCP (UL 94V-0) black, standard.

SURFACE PLATE: Stainless steel with tin plate.

MOVABLE CONTACT: Phosphor bronze with gold plate over nickel plate.

STATIONARY CONTACTS: Copper alloy, with gold plate over nickel plate.

TERMINALS: Copper alloy, with tin-lead alloy over nickel plate.

All terminals insert molded.

TERMINAL SEAL: Epoxy.

NOTE: Specifications and materials listed above are for switches with standard options. For information on specific and custom switches, consult Customer Service Center.

PART NUMBER	SWITCH FUNCTION		
	POS. 1	POS. 2	POS. 3
ES01MCKE	ON	NONE	ON
ES03MCKE	ON	OFF	ON
CONN. TERMINALS	2-3	OPEN	2-1
SCHEMATIC SPDT 			
ES02MCKE	OFF	NONE	ON
CONN. TERMINALS	OPEN	N/A	3-1
SCHEMATIC SPST 			

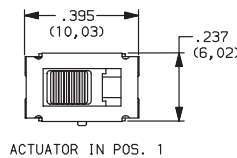

PC MOUNTING

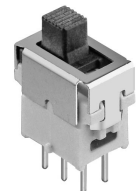
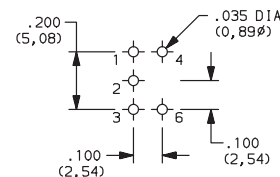

ES01MCKE
SPDT

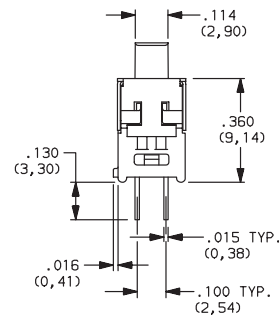
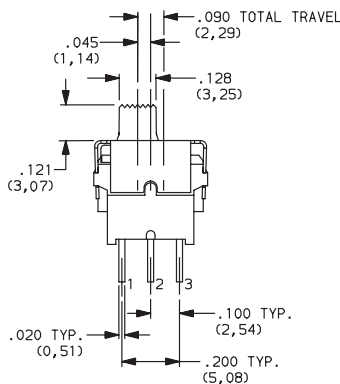

ES Series Sealed Tiny Slide Switches *New!*

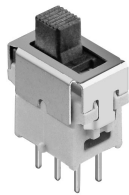

ES21MCKE
DPDT

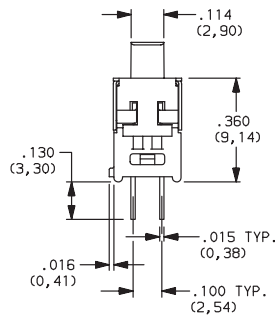
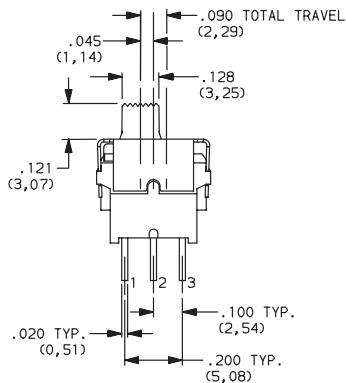
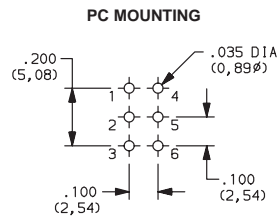
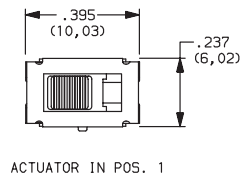

PART NUMBER	SWITCH FUNCTION		
	POS. 1	POS. 2	POS. 3
ES21MCKE	ON	NONE	ON
ES23MCKE	ON	OFF	ON
CONN. TERMINALS	2-3, 5-6	OPEN	2-1, 5-4
SCHEMATIC			
DPDT			
ES22MCKE	OFF	NONE	ON
CONN. TERMINALS	OPEN	N/A	3-1, 6-4
SCHEMATIC			
DPST			

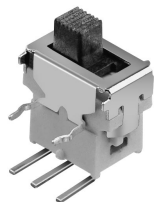

ES01MAKE
SPDT

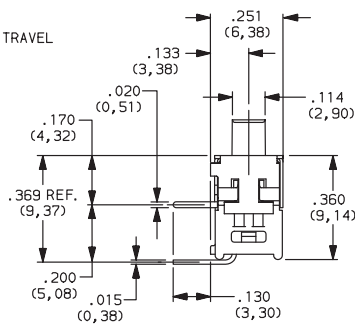
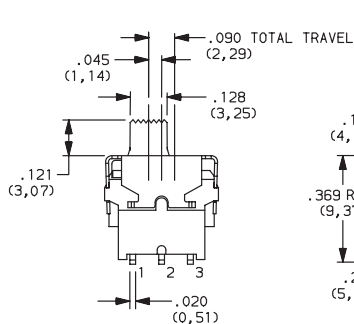
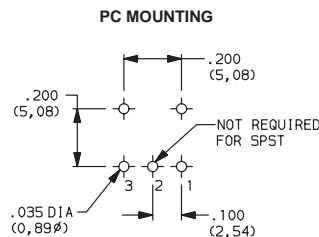
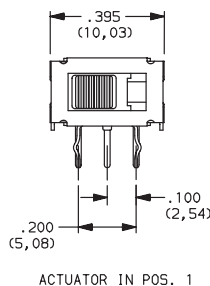

PART NUMBER	SWITCH FUNCTION		
	POS. 1	POS. 2	POS. 3
ES01MAKE	ON	NONE	ON
ES03MAKE	ON	OFF	ON
CONN. TERMINALS	2-3	OPEN	2-1
SCHEMATIC			
SPDT			
ES02MAKE	OFF	NONE	ON
CONN. TERMINALS	OPEN	N/A	3-1
SCHEMATIC			
SPST			

PART NUMBER	SWITCH FUNCTION		
	POS. 1	POS. 2	POS. 3
ES21MAKE	ON	NONE	ON
ES23MAKE	ON	OFF	ON
CONN. TERMINALS	2-3, 5-6	OPEN	2-1, 5-4
SCHEMATIC			
DPDT			
ES22MAKE	OFF	NONE	ON
CONN. TERMINALS	OPEN	N/A	3-1, 6-4
SCHEMATIC			
DPST			

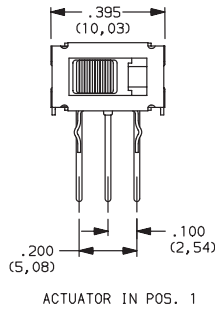

PC MOUNTING

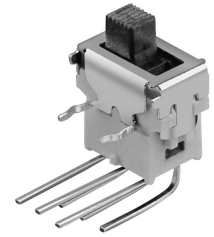
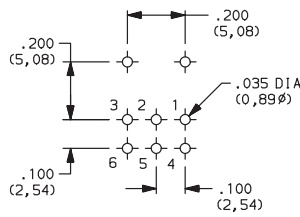

ES21MAKE
DPDT

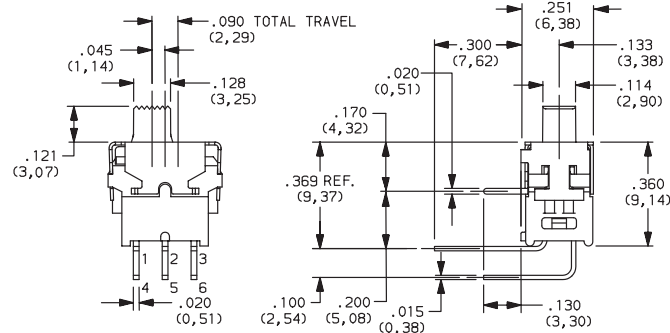

PART NUMBER	SWITCH FUNCTION		
	POS. 1	POS. 2	POS. 3
ES01MAVKE	ON	NONE	ON
ES03MAVKE	ON	OFF	ON
CONN. TERMINALS	2-3	OPEN	2-1
SCHEMATIC			
SPDT			
ES02MAVKE	OFF	NONE	ON
CONN. TERMINALS	OPEN	N/A	3-1
SCHEMATIC			
SPST			

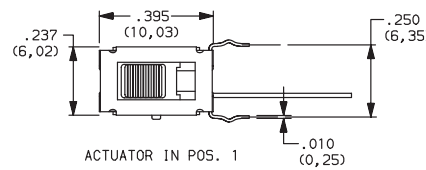

PC MOUNTING

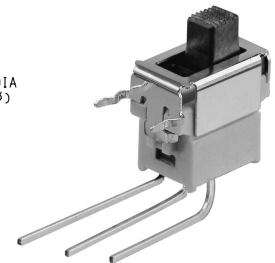
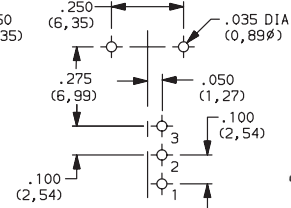

ES01MAVKE
SPDT

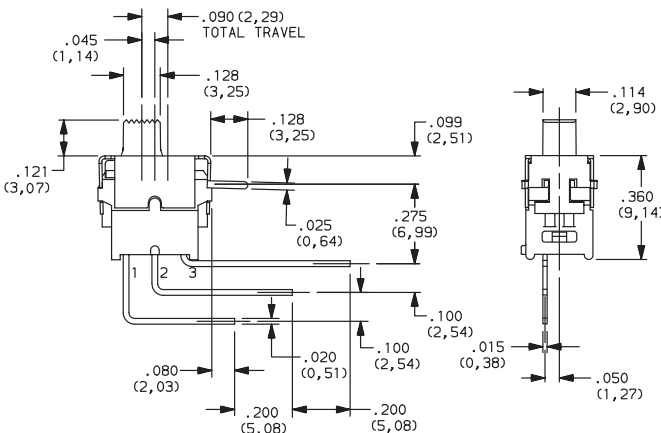

ES Series Sealed Tiny Slide Switches *New!*

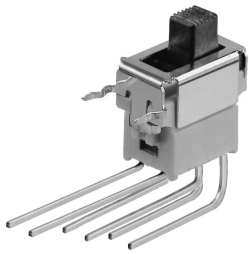

ES21MAVKE
DPDT

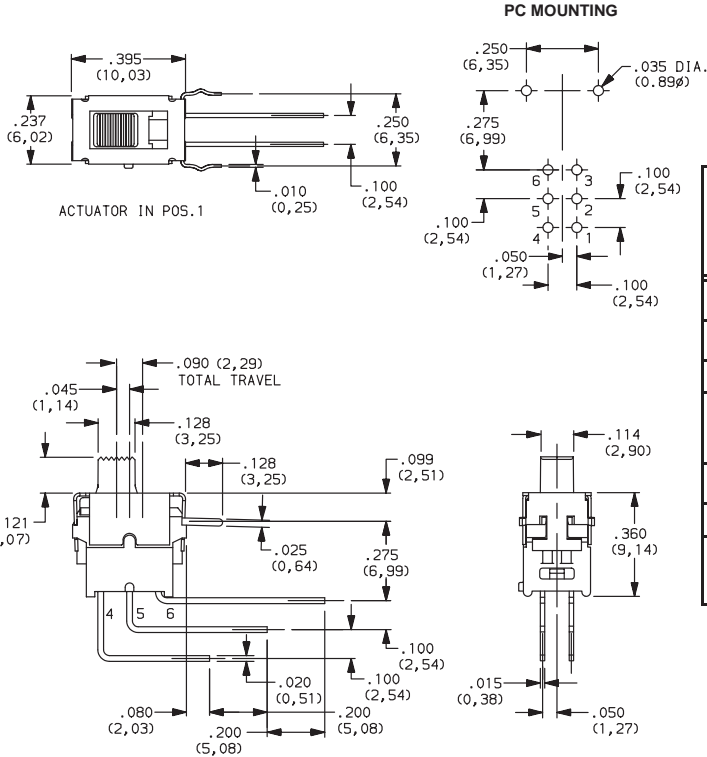

PART NUMBER	SWITCH FUNCTION		
	POS. 1	POS. 2	POS. 3
ES21MAVKE	ON	NONE	ON
ES23MAVKE	ON	OFF	ON
CONN. TERMINALS	2-3, 5-6	OPEN	2-1, 5-4
SCHEMATIC			
DPDT			
ES22MAVKE	OFF	NONE	ON
CONN. TERMINALS	OPEN	N/A	3-1, 6-4
SCHEMATIC			
DPST			

SMT



ES01MSAKE
Horizontal Actuation
SPDT

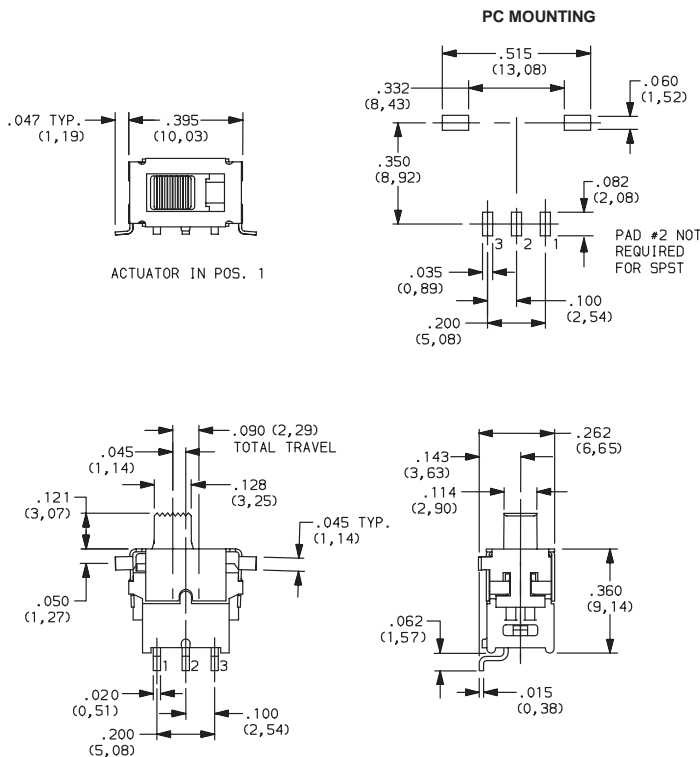

PART NUMBER	SWITCH FUNCTION		
	POS. 1	POS. 2	POS. 3
ES01MSAKE	ON	NONE	ON
ES03MSAKE	ON	OFF	ON
CONN. TERMINALS	2-3	OPEN	2-1
SCHEMATIC			
SPDT			
ES02MSAKE	OFF	NONE	ON
CONN. TERMINALS	OPEN	N/A	3-1
SCHEMATIC			
SPST			