

GA200SA60U

INSULATED GATE BIPOLAR TRANSISTOR

Ultra-Fast™ Speed IGBT

Features

- UltraFast: Optimized for minimum saturation voltage and operating frequencies up to 40 kHz in hard switching, > 200 kHz in resonant mode
- Very low conduction and switching losses
- Fully isolate package (2,500 Volt AC/RMS)
- Very low internal inductance (≤ 5 nH typ.)
- Industry standard outline

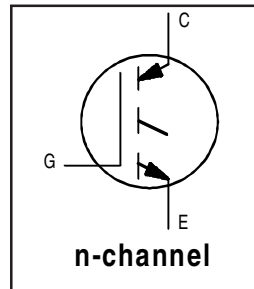

$V_{CES} = 600V$
$V_{CE(on)} \text{ typ.} = 1.60V$
@ $V_{GE} = 15V, I_C = 100A$

Benefits

- Designed for increased operating efficiency in power conversion: UPS, SMPS, Welding, Induction heating
- Lower overall losses available at frequencies ≥ 20kHz
- Easy to assemble and parallel
- Direct mounting to heatsink
- Lower EMI, requires less snubbing
- Plug-in compatible with other SOT-227 packages

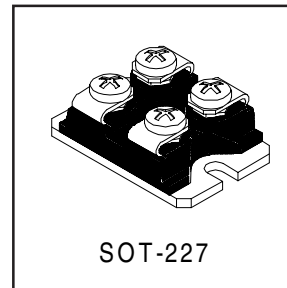

Absolute Maximum Ratings

	Parameter	Max.	Units
V_{CES}	Collector-to-Emitter Breakdown Voltage	600	V
$I_C @ T_C = 25^\circ C$	Continuous Collector Current	200	A
$I_C @ T_C = 100^\circ C$	Continuous Collector Current	100	
I_{CM}	Pulsed Collector Current	400	
I_{LM}	Clamped Inductive Load Current ^②	400	
V_{GE}	Gate-to-Emitter Voltage	± 20	V
E_{ARV}	Reverse Voltage Avalanche Energy ^③	160	mJ
V_{ISOL}	RMS Isolation Voltage, Any Terminal to Case, t=1 min	2500	V
$P_D @ T_C = 25^\circ C$	Maximum Power Dissipation	500	W
$P_D @ T_C = 100^\circ C$	Maximum Power Dissipation	200	
T_J	Operating Junction	-55 to + 150	°C
T_{STG}	Storage Temperature Range	-55 to + 150	
	Mounting Torque, 6-32 or M3 Screw	12 lbf •in(1.3N•m)	

Thermal Resistance

	Parameter	Typ.	Max.	Units
$R_{\theta JC}$	Junction-to-Case	—	0.25	°C/W
$R_{\theta CS}$	Case-to-Sink, Flat, Greased Surface	0.05	—	
Wt	Weight of Module	30	—	gm

www.irf.com

1

4/24/2000

GA200SA60U

Electrical Characteristics @ $T_J = 25^\circ\text{C}$ (unless otherwise specified)

	Parameter	Min.	Typ.	Max.	Units	Conditions
$V_{(BR)CES}$	Collector-to-Emitter Breakdown Voltage	600	—	—	V	$V_{GE} = 0V, I_C = 250\mu\text{A}$
$V_{(BR)ECS}$	Emitter-to-Collector Breakdown Voltage ④	18	—	—	V	$V_{GE} = 0V, I_C = 1.0A$
$DV_{(BR)CES}/DT_J$	Temperature Coeff. of Breakdown Voltage	—	0.38	—	V/°C	$V_{GE} = 0V, I_C = 10\text{ mA}$
$V_{CE(ON)}$	Collector-to-Emitter Saturation Voltage	—	1.60	1.9	V	$I_C = 100A$ $V_{GE} = 15V$ $I_C = 200A$ See Fig.2, 5 $I_C = 100A, T_J = 150^\circ\text{C}$
		—	1.92	—		
		—	1.54	—		
$V_{GE(th)}$	Gate Threshold Voltage	3.0	—	6.0		$V_{CE} = V_{GE}, I_C = 250\mu\text{A}$
$\Delta V_{GE(th)}/\Delta T_J$	Temperature Coeff. of Threshold Voltage	—	-11	—	mV/°C	$V_{CE} = V_{GE}, I_C = 2.0\text{ mA}$
g_{fe}	Forward Transconductance ⑤	79	—	—	S	$V_{CE} = 100V, I_C = 100A$
I_{CES}	Zero Gate Voltage Collector Current	—	—	1.0	mA	$V_{GE} = 0V, V_{CE} = 600V$
		—	—	10		$V_{GE} = 0V, V_{CE} = 600V, T_J = 150^\circ\text{C}$
I_{GES}	Gate-to-Emitter Leakage Current	—	—	± 250	nA	$V_{GE} = \pm 20V$

Switching Characteristics @ $T_J = 25^\circ\text{C}$ (unless otherwise specified)

	Parameter	Min.	Typ.	Max.	Units	Conditions
Q_g	Total Gate Charge (turn-on)	—	770	1200	nC	$I_C = 100A$ $V_{CC} = 400V$ See Fig. 8 $V_{GE} = 15V$
Q_{ge}	Gate - Emitter Charge (turn-on)	—	100	150		
Q_{gc}	Gate - Collector Charge (turn-on)	—	260	380		
$t_{d(on)}$	Turn-On Delay Time	—	54	—	ns	$T_J = 25^\circ\text{C}$ $I_C = 100A, V_{CC} = 480V$ $V_{GE} = 15V, R_G = 2.0\Omega$ Energy losses include "tail"
t_r	Rise Time	—	79	—		
$t_{d(off)}$	Turn-Off Delay Time	—	130	200		
t_f	Fall Time	—	300	450		
E_{on}	Turn-On Switching Loss	—	0.98	—	mJ	See Fig. 9, 10, 14
E_{off}	Turn-Off Switching Loss	—	3.48	—		
E_{ts}	Total Switching Loss	—	4.46	7.6		
$t_{d(on)}$	Turn-On Delay Time	—	56	—	ns	$T_J = 150^\circ\text{C},$ $I_C = 100A, V_{CC} = 480V$ $V_{GE} = 15V, R_G = 2.0\Omega$ Energy losses include "tail"
t_r	Rise Time	—	75	—		
$t_{d(off)}$	Turn-Off Delay Time	—	160	—		
t_f	Fall Time	—	460	—		
E_{ts}	Total Switching Loss	—	7.24	—	mJ	See Fig. 10, 11, 14
L_E	Internal Emitter Inductance	—	5.0	—	nH	Measured 5mm from package
C_{ies}	Input Capacitance	—	16500	—	pF	$V_{GE} = 0V$ $V_{CC} = 30V$ See Fig. 7 $f = 1.0\text{MHz}$
C_{oes}	Output Capacitance	—	1000	—		
C_{res}	Reverse Transfer Capacitance	—	200	—		

Notes:

- ① Repetitive rating; $V_{GE} = 20V$, pulse width limited by max. junction temperature. (See fig. 13b)
- ② $V_{CC} = 80\%(V_{CES}), V_{GE} = 20V, L = 10\mu\text{H}, R_G = 2.0\Omega$, (See fig. 13a)
- ③ Repetitive rating; pulse width limited by maximum junction temperature.
- ④ Pulse width $\leq 80\mu\text{s}$; duty factor $\leq 0.1\%$.
- ⑤ Pulse width $5.0\mu\text{s}$, single shot.

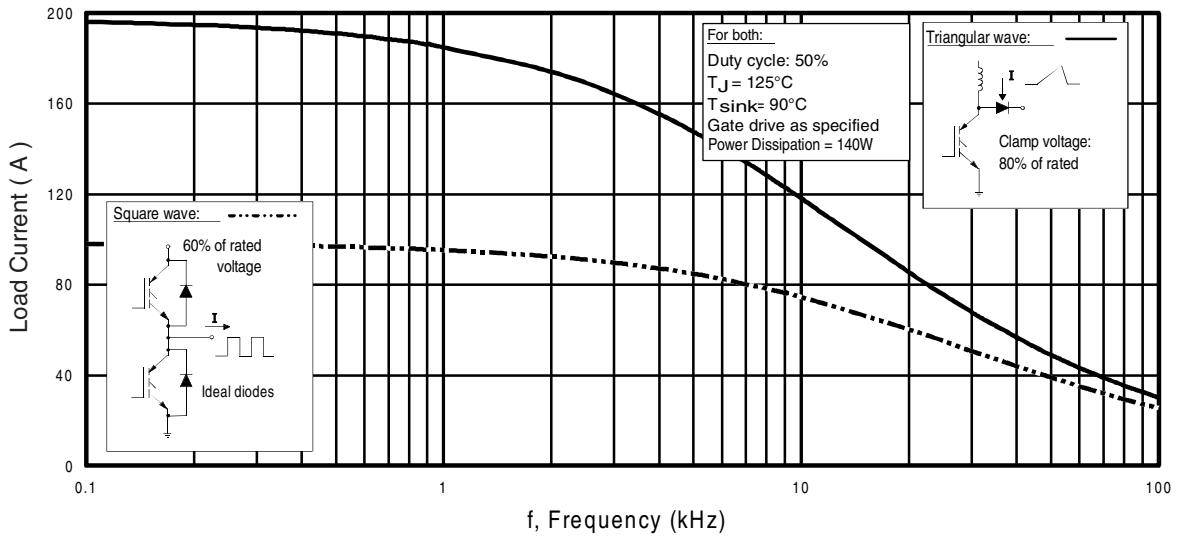

Fig. 1 - Typical Load Current vs. Frequency
(Load Current = I_{RMS} of fundamental)

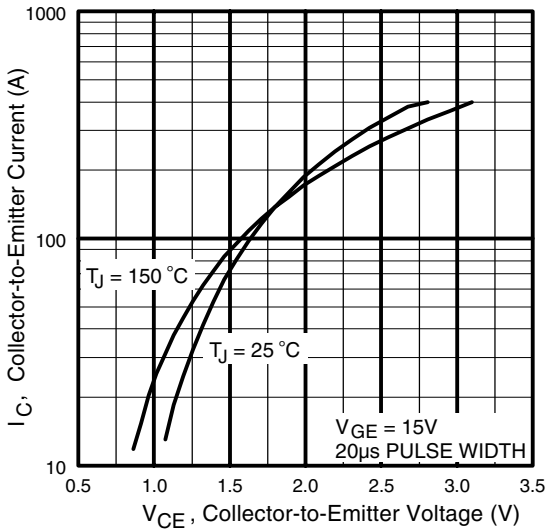

Fig. 2 - Typical Output Characteristics

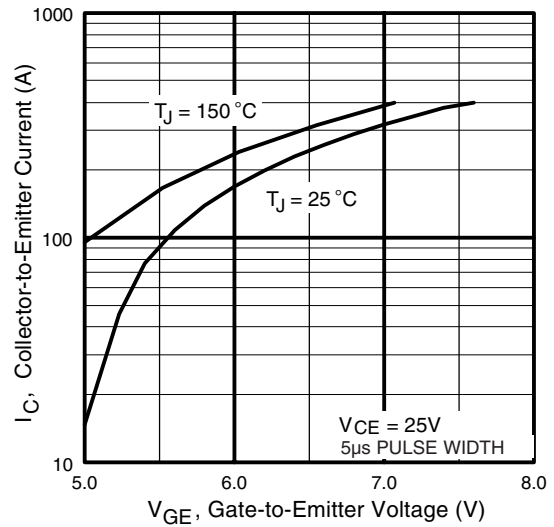

Fig. 3 - Typical Transfer Characteristics

GA200SA60U

International
IR Rectifier

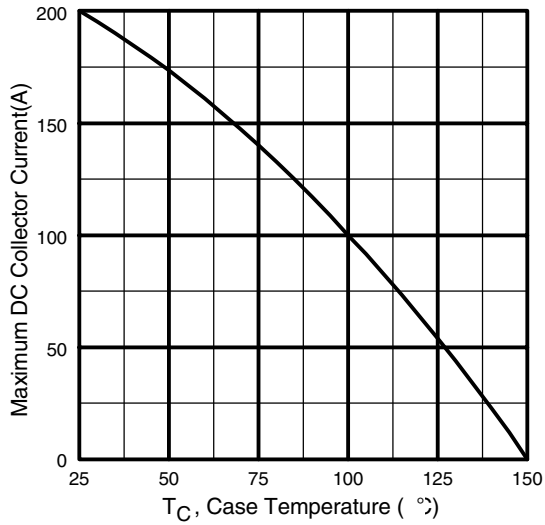

Fig. 4 - Maximum Collector Current vs. Case Temperature

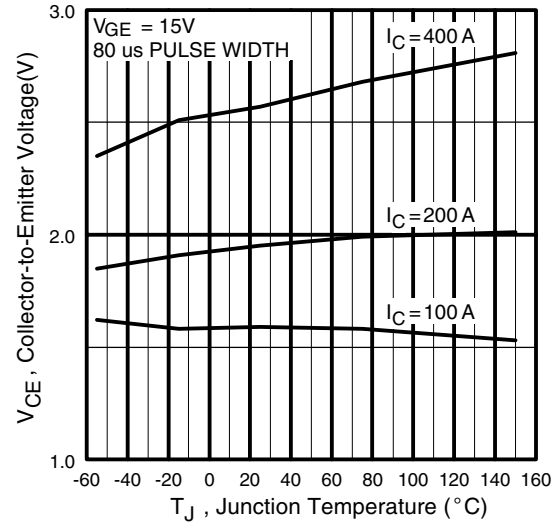

Fig. 5 - Typical Collector-to-Emitter Voltage vs. Junction Temperature

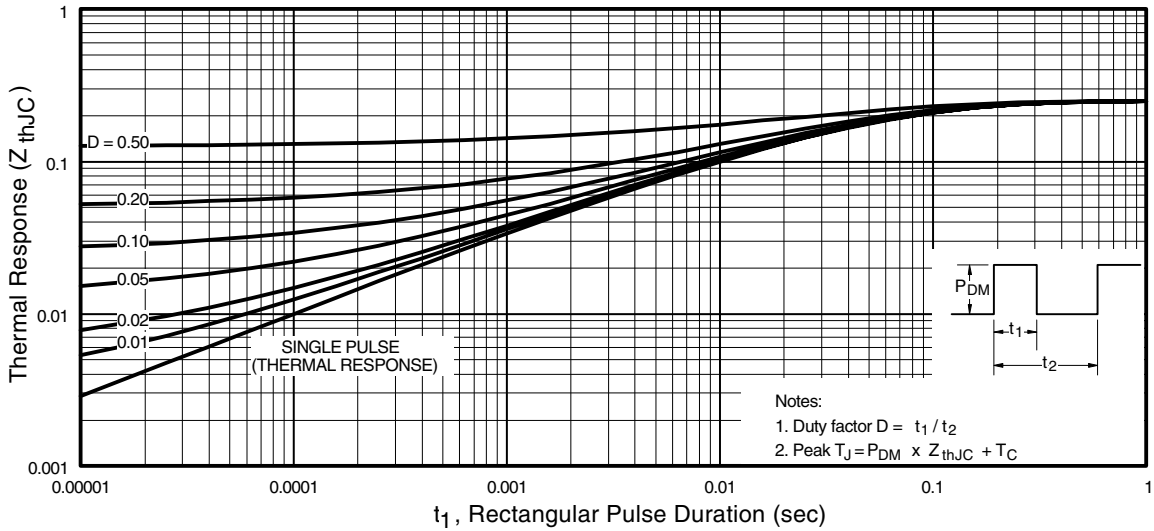

Fig. 6 - Maximum Effective Transient Thermal Impedance, Junction-to-Case

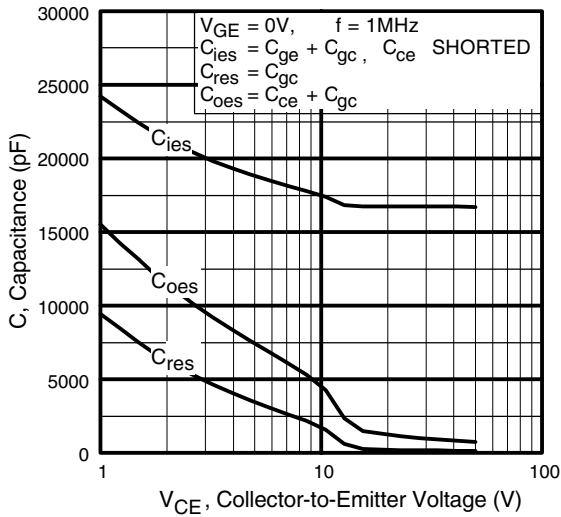

Fig. 7 - Typical Capacitance vs. Collector-to-Emitter Voltage

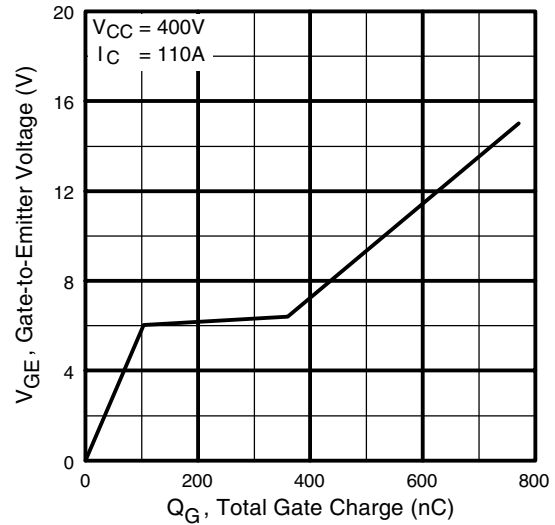

Fig. 8 - Typical Gate Charge vs. Gate-to-Emitter Voltage

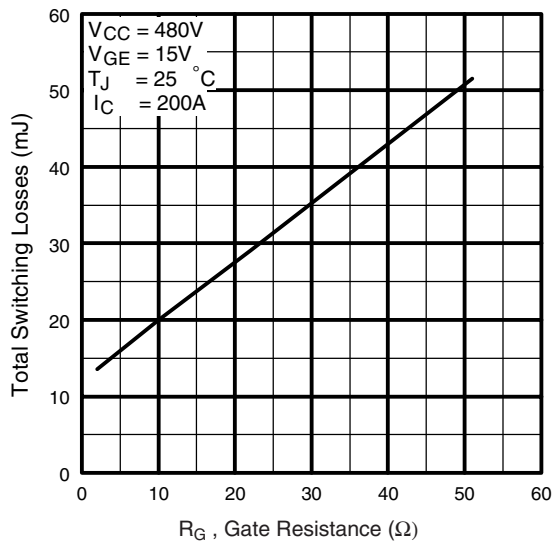

Fig. 9 - Typical Switching Losses vs. Gate Resistance

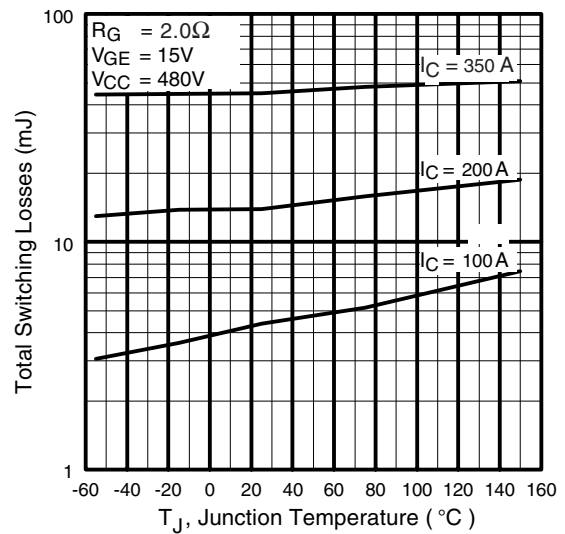

Fig. 10 - Typical Switching Losses vs. Junction Temperature

GA200SA60U

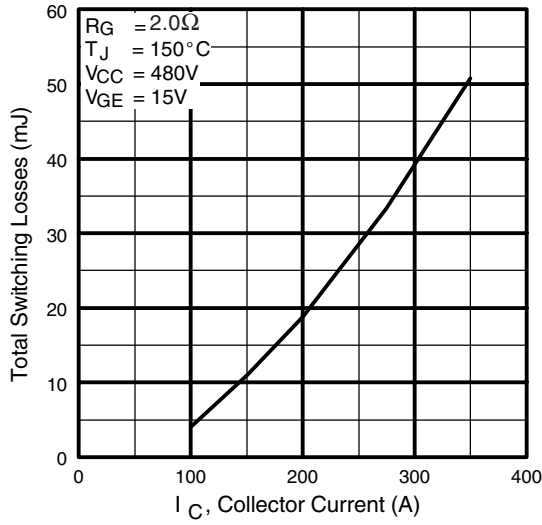

Fig. 11 - Typical Switching Losses vs. Collector Current

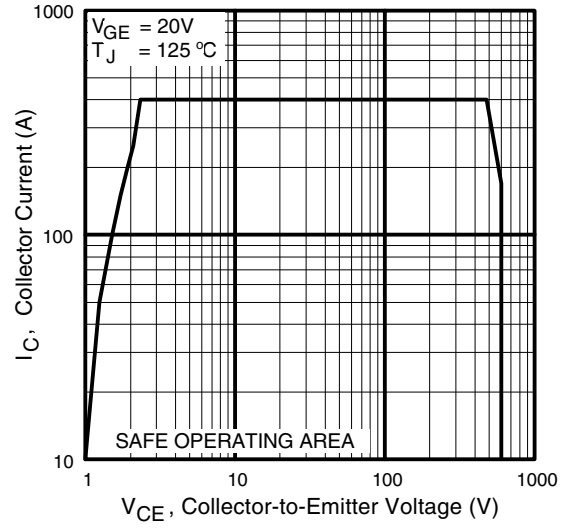

Fig. 12 - Turn-Off SOA



Fig. 13a - Clamped Inductive Load Test Circuit

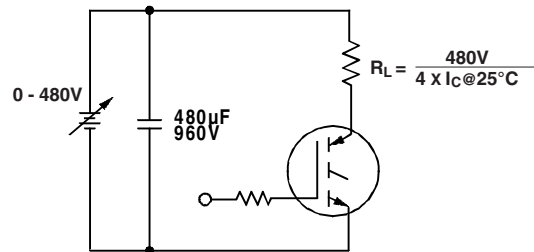

Fig. 13b - Pulsed Collector Current Test Circuit

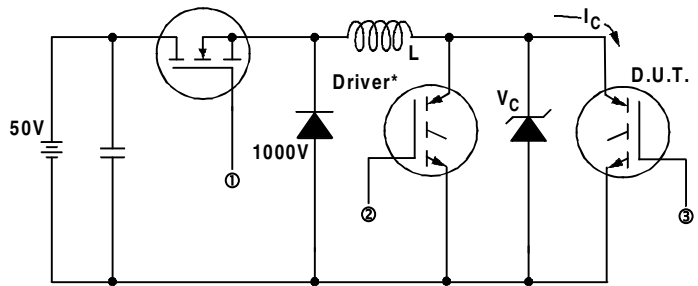

Fig. 14a - Switching Loss Test Circuit

* Driver same type as D.U.T., $V_C = 480V$



Fig. 14b - Switching Loss Waveforms

GA200SA60U

SOT-227 Package Details

Dimensions are shown in millimeters (inches)

International
IR Rectifier

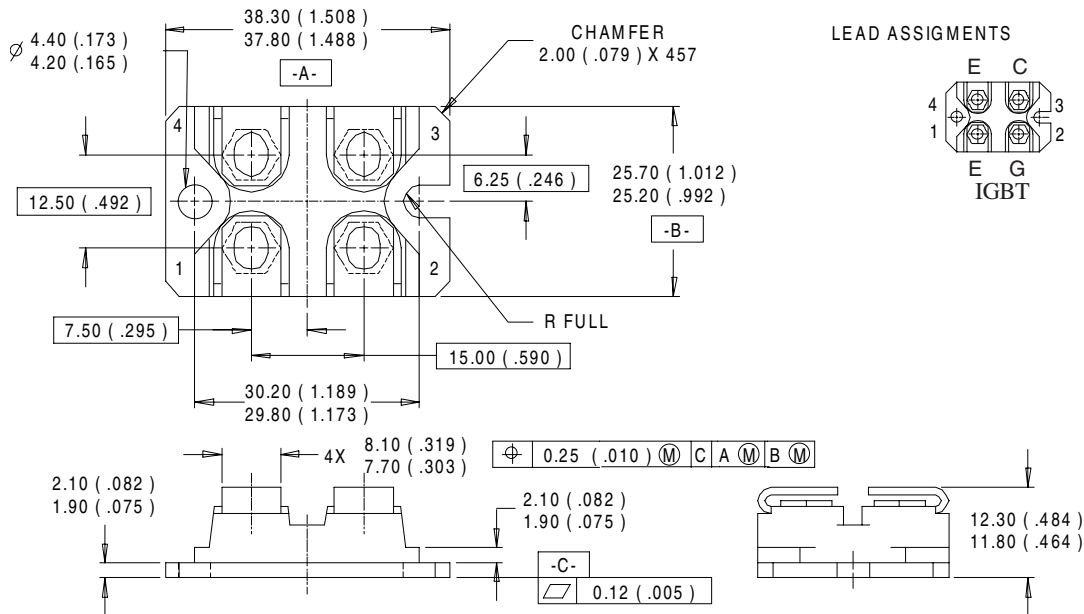

Tube

QUANTITIES PER TUBE IS 10
M4 SREW AND WASHER INCLUDED

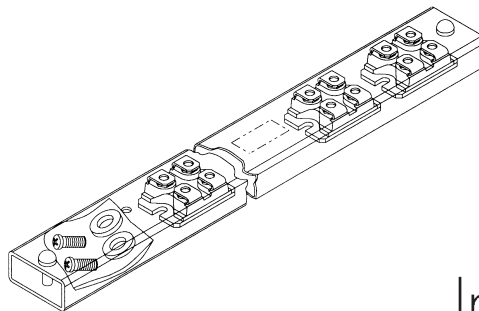

International
IR Rectifier

IR WORLD HEADQUARTERS: 233 Kansas St., El Segundo, California 90245, USA Tel: (310) 252-7105
IR EUROPEAN REGIONAL CENTRE: 439/445 Godstone Rd, Whyteleafe, Surrey CR3 OBL, UK Tel: ++ 44 (0)20 8645 8000
IR CANADA: 15 Lincoln Court, Brampton, Ontario L6T3Z2, Tel: (905) 453 2200
IR GERMANY: Saalburgstrasse 157, 61350 Bad Homburg Tel: ++ 49 (0) 6172 96590
IR ITALY: Via Liguria 49, 10071 Borgaro, Torino Tel: ++ 39 011 451 0111
IR JAPAN: K&H Bldg., 2F, 30-4 Nishi-Ikebukuro 3-Chome, Toshima-Ku, Tokyo 171 Tel: 81 (0)3 3983 0086
IR SOUTHEAST ASIA: 1 Kim Seng Promenade, Great World City West Tower, 13-11, Singapore 237994 Tel: ++ 65 (0)838 4630
IR TAIWAN: 16 Fl. Suite D. 207, Sec. 2, Tun Haw South Road, Taipei, 10673 Tel: 886-(0)2 2377 9936

Data and specifications subject to change without notice. 4/00