

JS Series Sub-Miniature Slide Switches

Features/Benefits

- Positive detent
- Low profile
- IR reflow to 260° solder profile
- Surface and thru hole mounting
- SPDT, DPDT, DP3T models
- RoHS compliant

Typical Applications

- Telecommunication products
- Computer peripherals
- Thermostat select switch
- Instrumentations

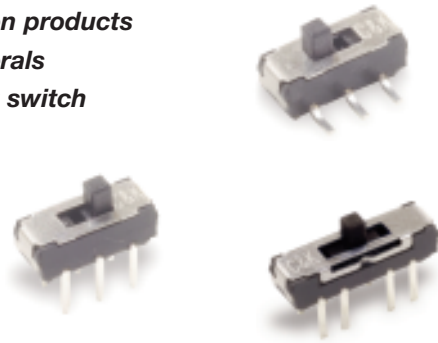

Specifications

CONTACT RATING: See individual series for information.
 ELECTRICAL LIFE: See individual series for information.
 CONTACT RESISTANCE: 70 m Ω max.
 INSULATION RESISTANCE: 100 M Ω min. @ 500V.
 DIELECTRIC STRENGTH: 500 VAC min. @ sea level.
 OPERATING TEMPERATURE: -10°C to +60°C
 STORAGE TEMPERATURE: -30°C to +85°C

NOTE: Specifications and materials listed above are for switches with standard options.
 For information on specific and custom switches, consult Customer Service Center.

Materials

HOUSING: 4/6 nylon (UL94V-2), black.
 ACTUATOR: 4/6 nylon (UL94V-2), black.
 CONTACTS: Copper alloy, silver plated.
 TERMINALS: Brass, silver plated

RIGHT ANGLE, PC THRU-HOLE

CONTACT RATING: 6 VDC @ 0.3A

ELECTRICAL LIFE: 5,000 make-and-break cycles.

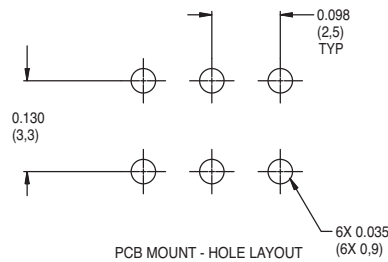
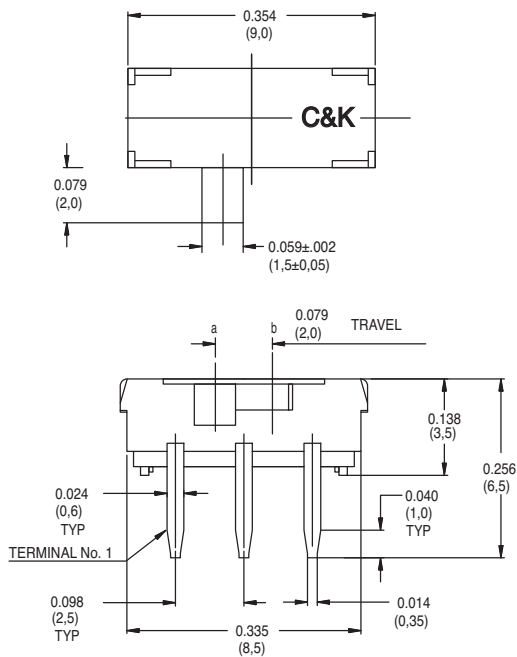

Part Number
JS202011AQN
DPDT

Shown in position 1a

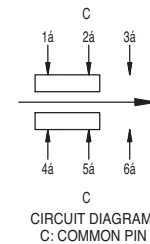
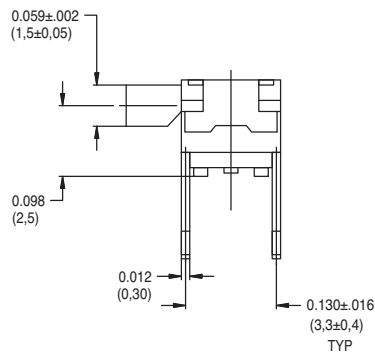

Dimensions are shown: Inch (mm)
 Specifications and dimensions subject to change



Slide

JS Series Sub-Miniature Slide Switches

RIGHT ANGLE, PC THRU-HOLE

CONTACT RATING: 6 VDC @ 0.3A

ELECTRICAL LIFE: 5,000 make-and-break cycles.

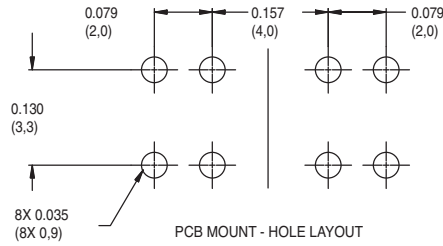
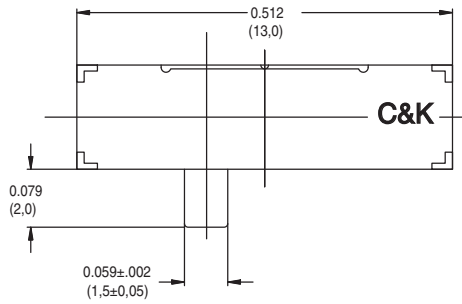

Part Number
JS203011AQN
DP3T

Shown in position 1a

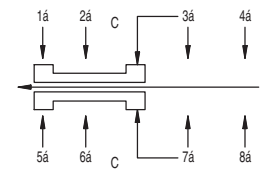
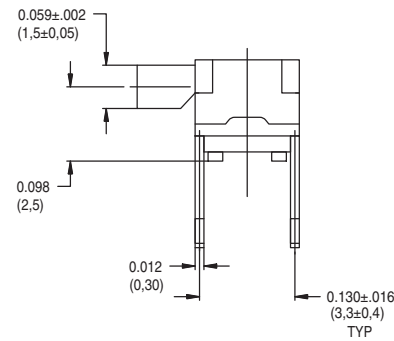
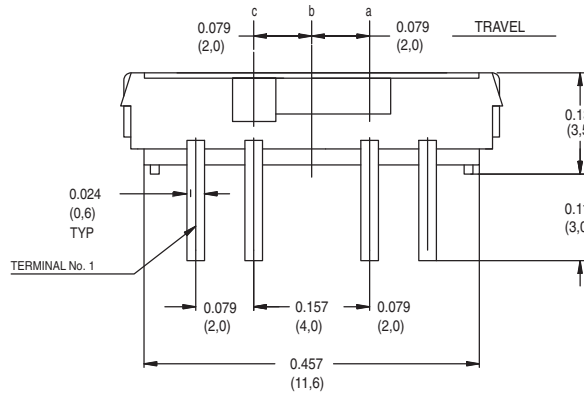

CIRCUIT DIAGRAM
C: COMMON PIN

Slide

PC THRU-HOLE

CONTACT RATING: 6 VDC @ 0.3A

ELECTRICAL LIFE: 5,000 make-and-break cycles.

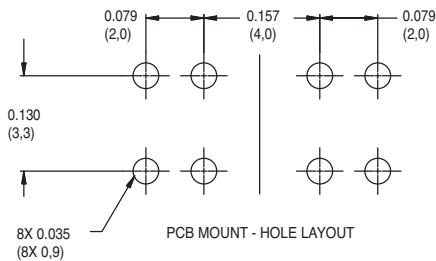
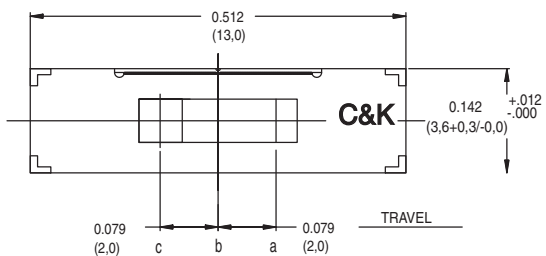

Part Number
JS203011CQN
DP3T

Shown in position 1a

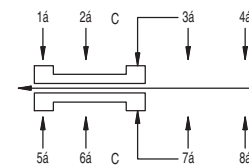
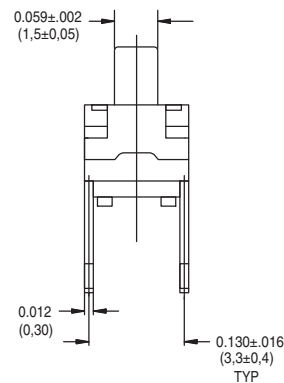
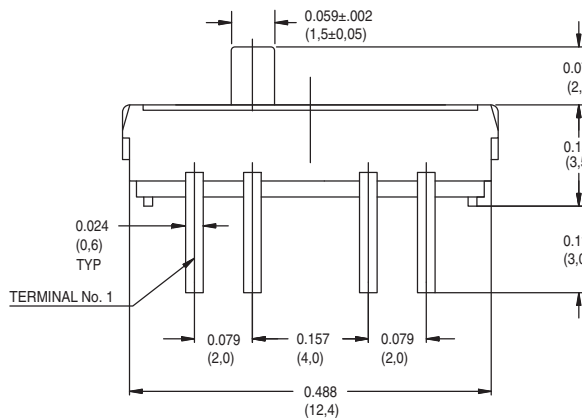

CIRCUIT DIAGRAM
C: COMMON PIN

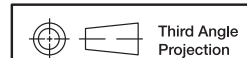

Third Angle
Projection

Dimensions are shown: Inch (mm)
Specifications and dimensions subject to change

JS Series Sub-Miniature Slide Switches

PC THRU-HOLE

CONTACT RATING: 6 VDC @ 0.3A
ELECTRICAL LIFE: 5,000 make-and-break cycles.

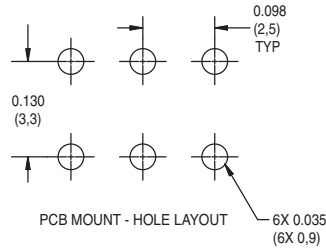
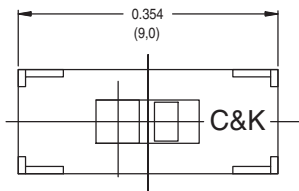

Part Number
JS202011CQN
DPDT

Shown in position 1a

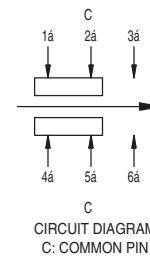
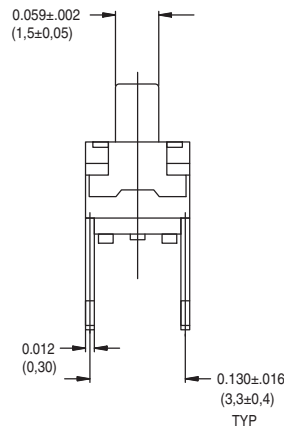
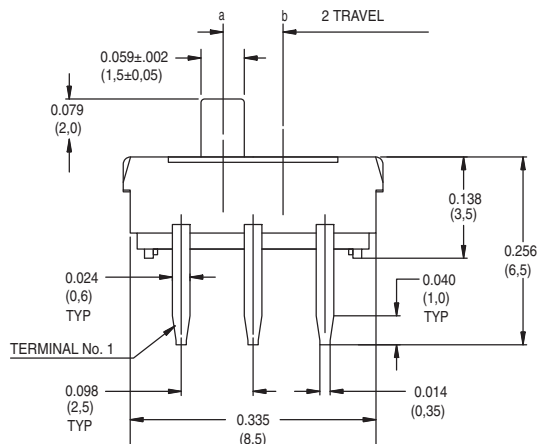

SURFACE MOUNT

CONTACT RATING: 6 VDC @ 0.3A
ELECTRICAL LIFE: 5,000 make-and-break cycles.

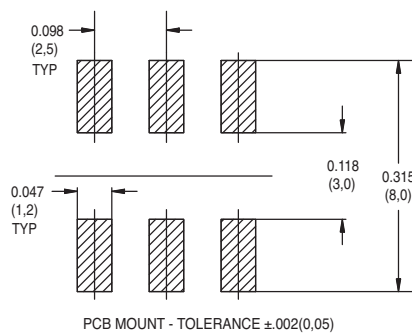
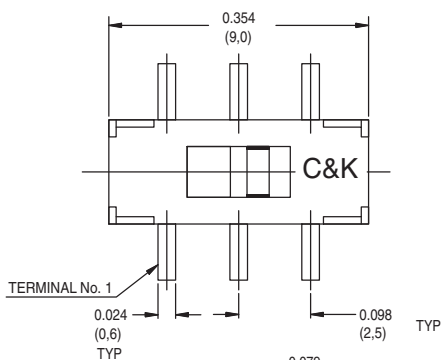

Part number
JS202011SCQN
DPDT

Shown in position 1a

Available in tape & reel only, see page J-54

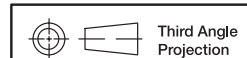
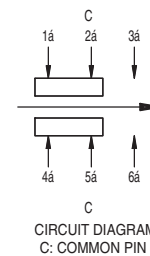
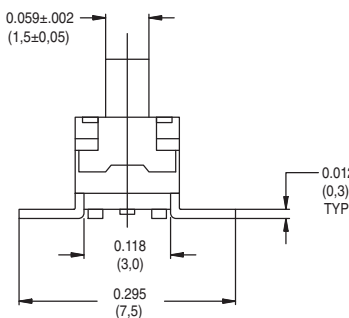
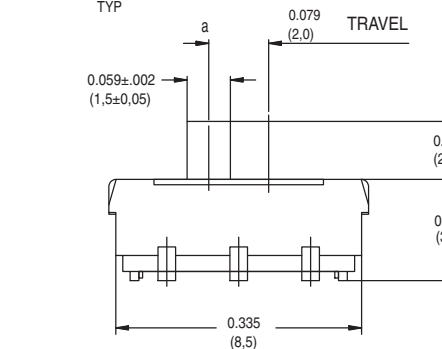

Dimensions are shown: Inch (mm)
Specifications and dimensions subject to change

Slide

JS Series Sub-Miniature Slide Switches

RIGHT ANGLE SURFACE MOUNT

CONTACT RATING: 6 VDC @ 0.3A

ELECTRICAL LIFE: 5,000 make-and-break cycles.

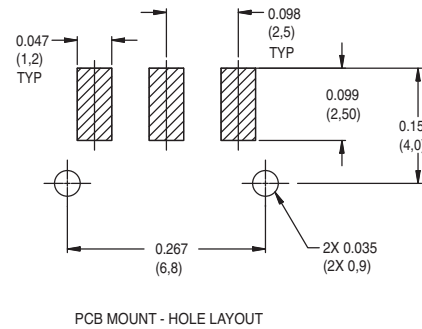
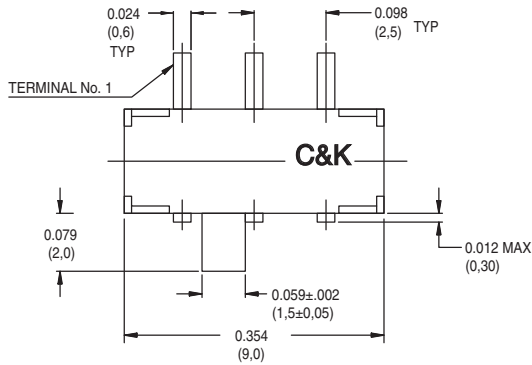

Part Number
JS102011SAQN
SPDT

Shown in position 1a

Available in tape & reel only, see page J-54



Slide

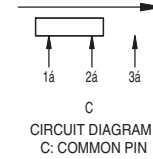
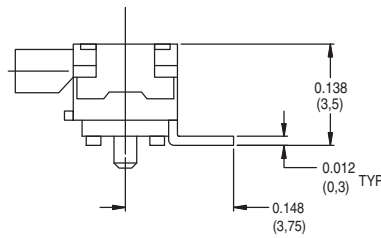
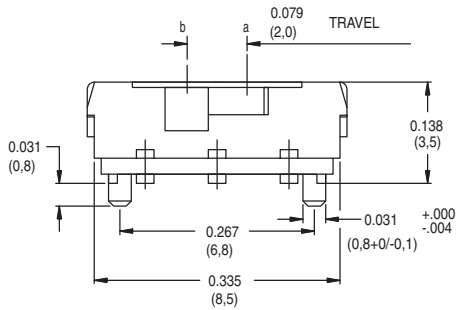

CONTACT RATING: 6 VDC @ 0.3A

CONTACT RATING: 30 VDC @ 0.1A

ELECTRICAL LIFE: 5,000 make-and-break cycles.

ELECTRICAL LIFE: 15,000 make-and-break cycles.

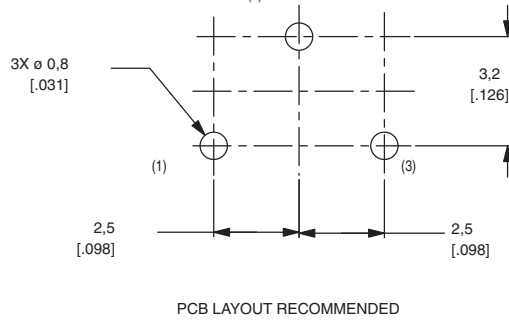
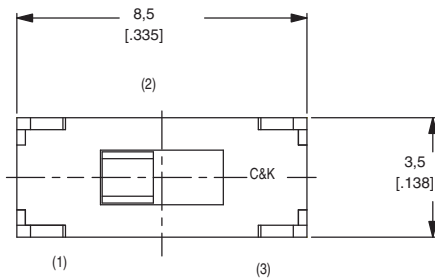

Part Number
JS102011CQN
SPDT

Shown in position 1

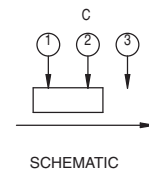
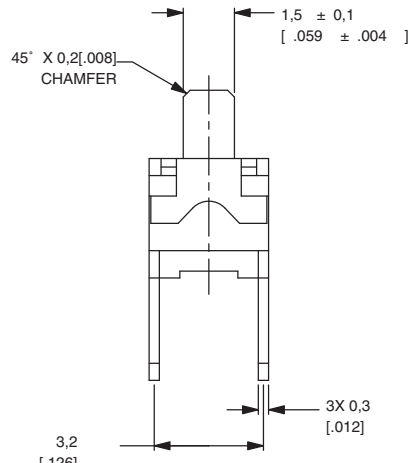
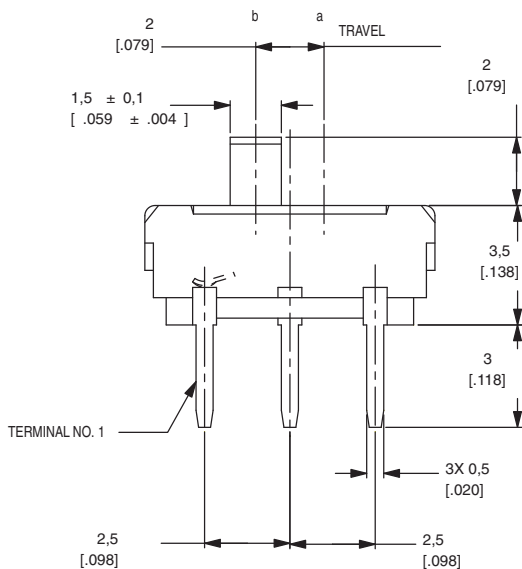

Dimensions are shown: Inch (mm)
Specifications and dimensions subject to change

C&K

www.ck-components.com

JS Series Sub-Miniature Slide Switches

CONTACT RATING: 6 VDC @ 0.3A
CONTACT RATING: 30 VDC @ 0.1A

ELECTRICAL LIFE: 5,000 make-and-break cycles.
ELECTRICAL LIFE: 15,000 make-and-break cycles.

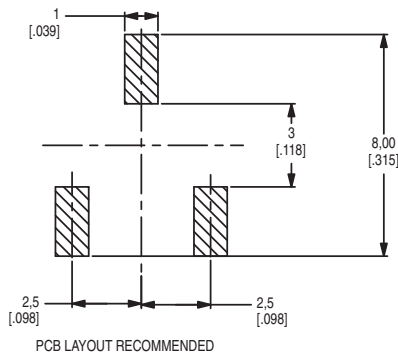
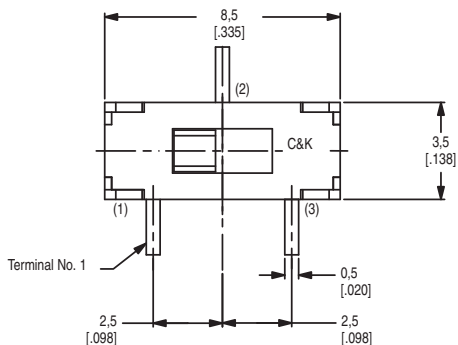

Part Number
JS102011SCQN
SPDT

Shown in position 1

Available in tape & reel
only, see page J-54

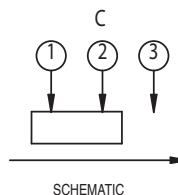
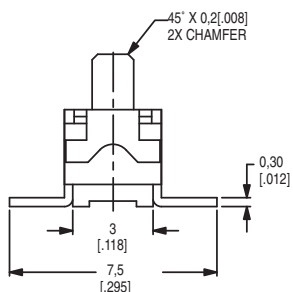
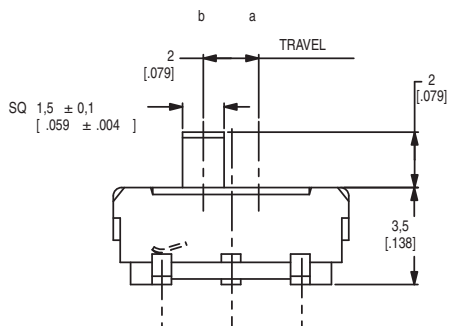
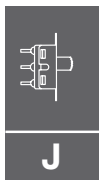

Slide

RIGHT ANGLE SURFACE MOUNT LOW PROFILE .028±.004 (0.7±0.1) HIGH

Specifications

CONTACT RATING: 5 VDC @ 1MA
ELECTRICAL LIFE: 10,000 cycles.
CONTACT RESISTANCE: <100 m ohms (initial) <200 m ohms (after processing).
INSULATION RESISTANCE: 100 m ohms @500 VDC.
DIELECTRIC STRENGTH: 250 VAC.
OPERATING TEMPERATURE: -20°C to +70°C

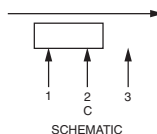
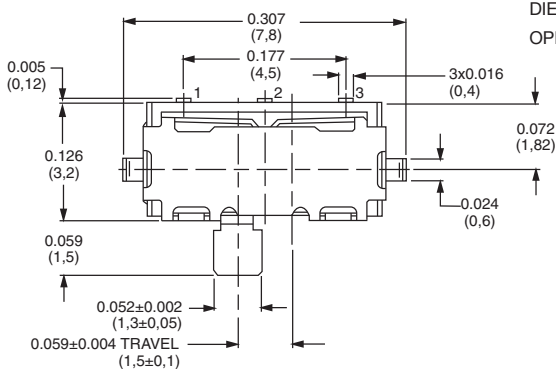

Part Number
JS102000SAQN
SPDT

Available in tape & reel
only, see page J-54

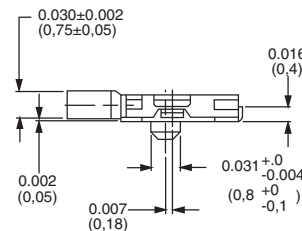
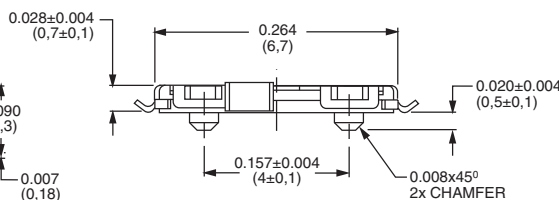
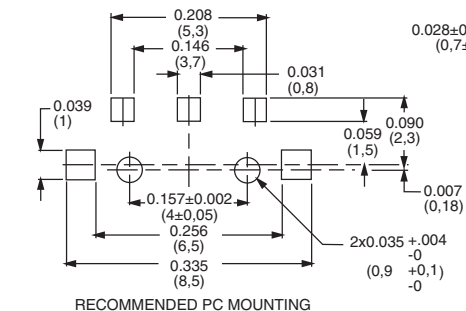

Dimensions are shown: Inch (mm)
Specifications and dimensions subject to change

JS Series Sub-Miniature Slide Switches

TAPE AND REEL FOR PART NUMBER JS10211SAQN

Quantity per reel 1000

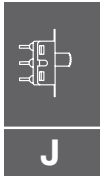
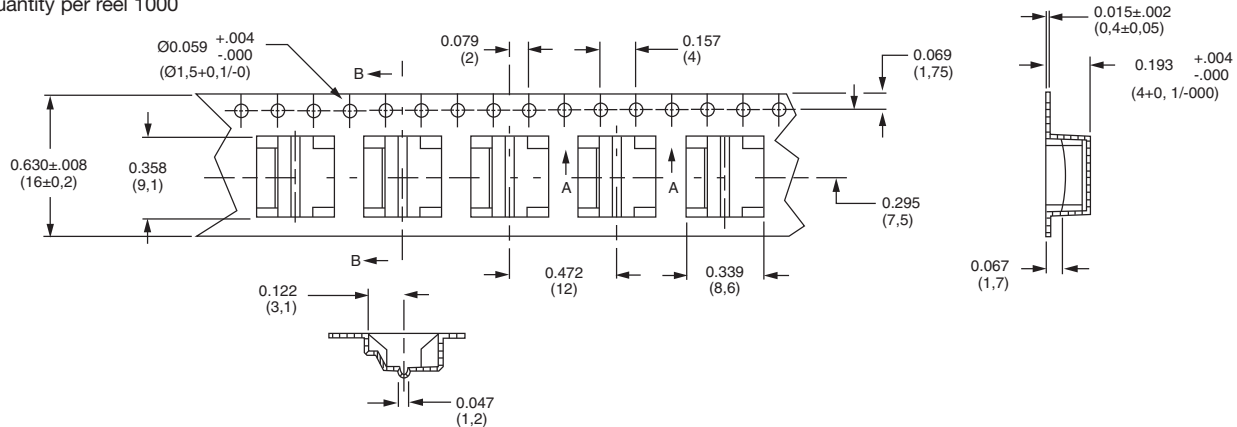

Slide

TAPE AND REEL FOR PART NUMBER JS102000SAQN

Quantity per reel 4000

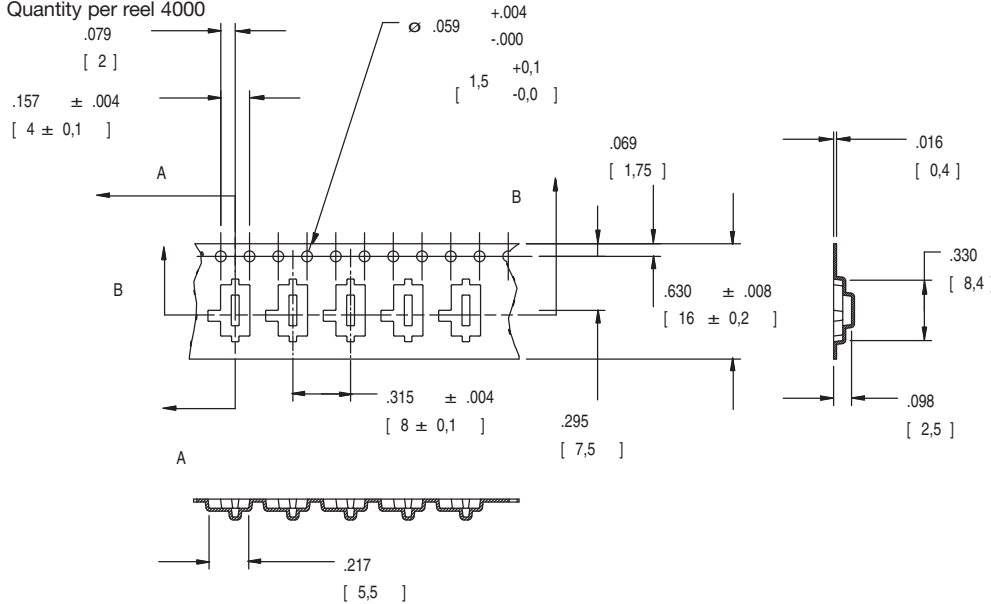

TAPE AND REEL FOR
PART NUMBER JS102011SCQN

Quantity per reel 1000

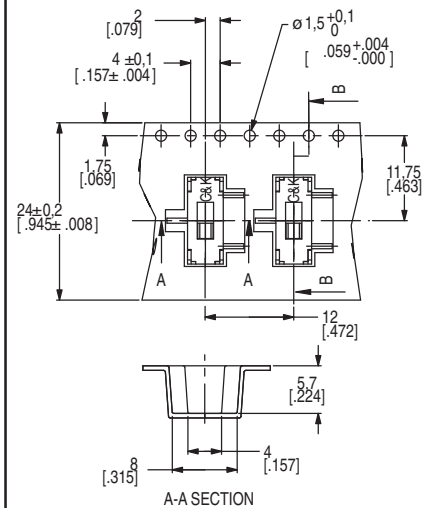

TAPE AND REEL FOR PART NUMBER JS202011SCQN

Quantity per reel 1000

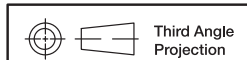
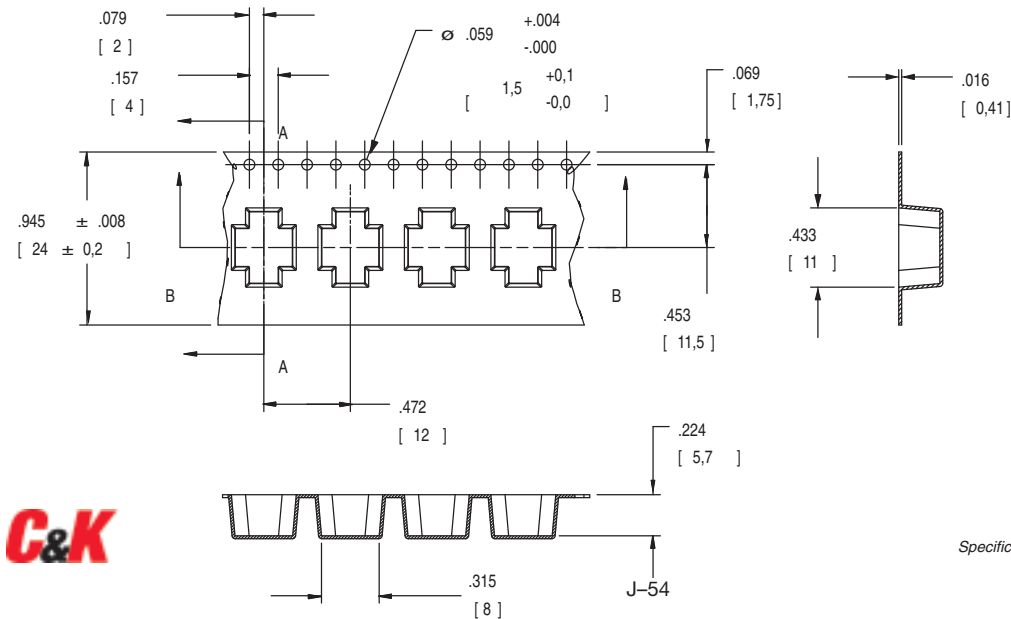

Dimensions are shown: Inch (mm)
Specifications and dimensions subject to change

www.ck-components.com

