

**Slide Switches, Low Profile, Instrumentation Grade**

**MATERIAL SPECIFICATIONS:**

Contacts .....Gold or silver over nickel over Cu alloy  
 Frame Material .....Nickel plated, Steel  
 Actuator Material .....POM 94 HB  
 Terminals/Fixed Contacts.....Gold or silver over nickel over Cu alloy  
 Terminal Seal .....Epoxy

**ENVIRONMENTAL SPECIFICATIONS:**

Operating Temperature.....-4°F to +212°F (-20°C to +100°C)  
 Storage Temperature.....-40°F to +212°F (-40°C to + 100°C)  
 Solder Heat Resistance .....See page M3-4  
 Recommended Cleaning.....No chlorine base or Freon can be used.  
 Aqueous or 100% ethanol.

**TYPICAL PERFORMANCE CHARACTERISTICS:**

Contact Rating .....Gold: 0.4 VA 20 VDC or peak AC  
 Silver: 300 mA @ 125 VAC  
 Initial Contact Resistance .....20 Milliohms max.  
 Contact Timing.....Make-before-break  
 Insulation Resistance .....1000 Megohms min.  
 Dielectric Strength .....500 Volts RMS @ sea level  
 Actuation Force .....50 to 450 Grams  
 Actuator Travel.....0.079"-.158" (2.01-4.01)  
 Life Expectancy .....Up to 15,000 Cycles

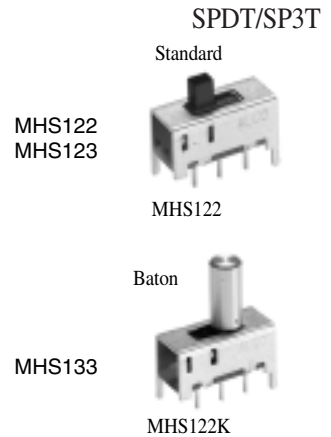
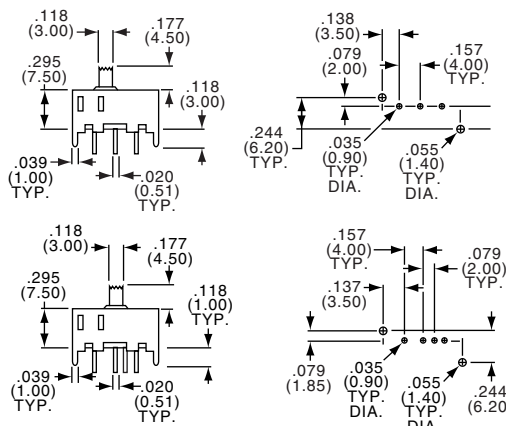
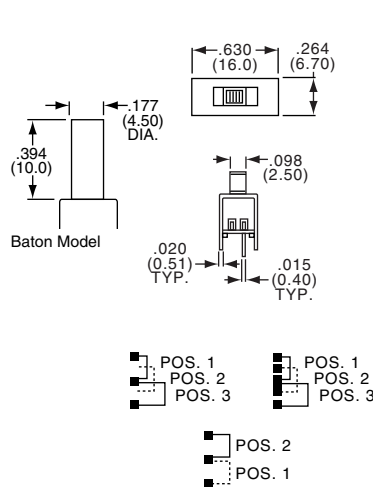

Standard Model Tyco Electronics	Alcoswitch	Baton Model Tyco Electronics	Alcoswitch	Type	On	None	Off	Contacts
1437576-9	MHS122	1-1437576-2	MHS122K	SPDT	On	None	On	Silver
1-1437576-5	MHS123	1-1437576-7	MHS123K	SPDT	On	Off	On	Silver
1-1437576-9	MHS133	2-1437576-2	MHS133K	SP3T	On	On	On	Silver
1-1437576-0	MHS122G	1-1437576-3	MHS122KG	SPDT	On	None	On	Gold
	MHS123G		MHS123KG	SPDT	On	Off	On	Gold
2-1437576-0	MHS133G	2-1437576-3	MHS133KG	SP3T	On	On	On	Gold

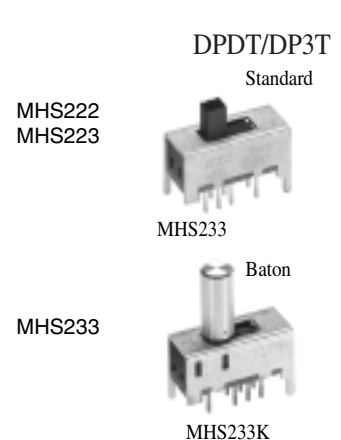
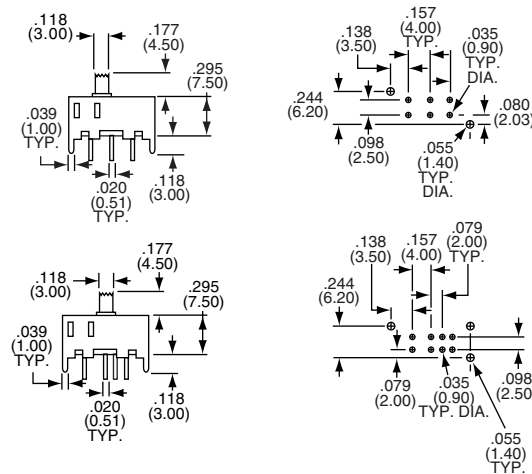
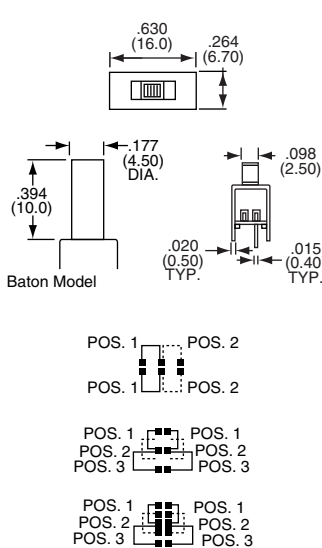

Standard Model Tyco Electronics	Alcoswitch	Baton Model Tyco Electronics	Alcoswitch	Type	On	None	Off	Contacts
2-1437576-5	MHS222	2-1437576-8	MHS222K	DPDT	On	None	On	Silver
3-1437576-1	MHS223	3-1437576-4	MHS223K	DPDT	On	Off	On	Silver
3-1437576-6	MHS233	3-1437576-9	MHS233K	DP3T	On	On	On	Silver
2-1437576-6	MHS222G	2-1437576-9	MHS222KG	DPDT	On	None	On	Gold
3-1437576-2	MHS223G	—	MHS223KG	DPDT	On	Off	On	Gold
3-1437576-7	MHS233G	4-1437576-0	MHS233KG	DP3T	On	On	On	Gold

**Slide Switches, Low Profile, Right Angle, Instrumentation Grade**

SEE PAGE B33 FOR PRODUCT SPECIFICATIONS

**B**  
MHS Series

**SPDT/SP3T**



MHS122RA



MHS133GRA

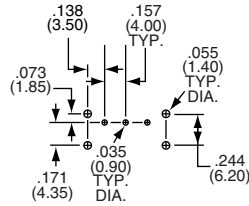
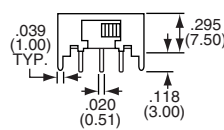
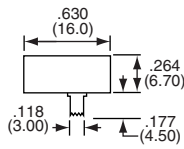

MHS122/123

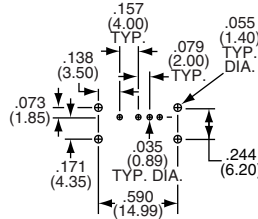
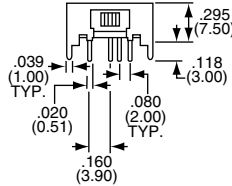
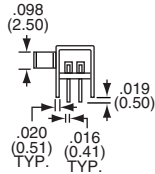

MHS133

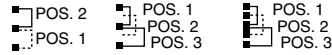

Tyco Electronics	Alcoswitch	Type				Contacts
1-1437576-4	MHS122RA	SPDT	On	None	On	Silver
1-1437576-8	MHS123RA	SPDT	On	Off	On	Silver
2-1437576-4	MHS133RA	SP3T	On	On	On	Silver
1-1437576-1	MHS122GRA	SPDT	On	None	On	Gold
1-1437576-6	MHS123GRA	SPDT	On	Off	On	Gold
2-1437576-1	MHS133GRA	SP3T	On	On	On	Gold

**DPDT/DP3T**



MHS222RA



MHS233GRA

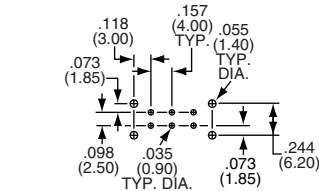
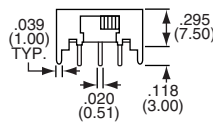
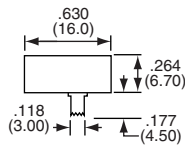

MHS222/223

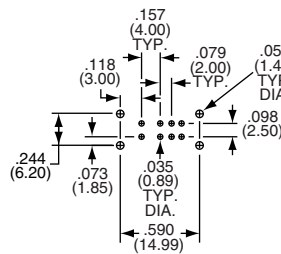
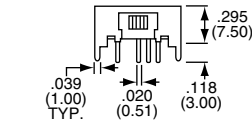
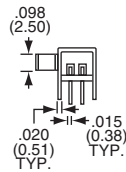

MHS233

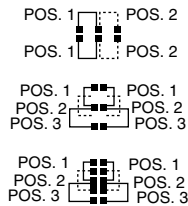

Tyco Electronics	Alcoswitch	Type				Contacts
3-1437576-0	MHS222RA	DPDT	On	None	On	Silver
3-1437576-5	MHS223RA	DPDT	On	Off	On	Silver
4-1437576-1	MHS233RA	DP3T	On	On	On	Silver
2-1437576-7	MHS222GRA	DPDT	On	None	On	Gold
3-1437576-3	MHS223GRA	DPDT	On	Off	On	Gold
3-1437576-8	MHS233GRA	DP3T	On	On	On	Gold

**Slide Switches, Micro Size, Instrumentation Grade**

**MATERIAL SPECIFICATIONS:**

Contacts .....Silver clad plate over copper alloy  
 Cover Base Material .....Polyester  
 Actuator Material .....Polyacetal  
 Terminals .....Silver over nickel plate over copper alloy  
 Terminal Seal .....Molded in

**TYPICAL PERFORMANCE CHARACTERISTICS:**

Contact Rating .....100 Milliamps @ 12 VDC  
 Initial Contact Resistance .....20 Milliohms max.  
 Contact Timing .....Make before break  
 Insulation Resistance .....100 Megohms min.  
 Dielectric Strength .....500 Volts RMS @ sea level  
 Actuation Force .....250 Grams, (+200g, -150g)  
 Actuator Travel .....0.079" (2.01)  
 Life Expectancy .....Up to 10,000 Cycles

**ENVIRONMENTAL SPECIFICATIONS:**

Operating Temperature .....+14°F to +140°F (-10°C to +60°C)  
 Storage Temperature .....-4°F to +140°F (-20°C to +60°C)  
 Solder Heat Resistance .....270°C+10°C, 5 seconds per MIL-STD-202, Method 210

**PCB Hole Layout**

**Circuit Diagram**

SPDT

SSJ12

Part Number			
Tyco Electronics	Alcoswitch	Plating	Mounting Style
3-1437575-1	SSJ12	Silver	Upright

**PCB Hole Layout**

**Circuit Diagram**

SPDT

SSJ12R

Part Number			
Tyco Electronics	Alcoswitch	Plating	Mounting Style
3-1437575-2	SSJ12R	Silver	Right Angle

**PCB Hole Layout**

**Circuit Diagram**

SP3T

SSJ13

Part Number			
Tyco Electronics	Alcoswitch	Plating	Mounting Style
3-1437575-3	SSJ13	Silver	Upright

**Slide Switches, Micro Size, Instrumentation Grade**

**MATERIAL SPECIFICATIONS:**

Contacts .....Silver over nickel over copper alloy  
 Case Material .....Polyacetal UL94HB  
 Actuator Material .....Polyester UL94HB  
 Terminals .....Silver over nickel over copper alloy  
 Terminal Seal .....Epoxy  
 Terminal Board.....UL 94 V-O

**ENVIRONMENTAL SPECIFICATIONS:**

Operating Temperature.....+14°F to +140°F (-10°C to +60°C)  
 Storage Temperature.....+14°F to +140°F (-10°C to +60°C)  
 Solder Heat Resistance.....230 ± 150 grams ± 5°C for 3 seconds per MIL-STD-202, Method 210

**TYPICAL PERFORMANCE CHARACTERISTICS:**

Contact Rating .....100 mA @ 30 VDC or peak AC  
 Initial Contact Resistance .....30 Milliohms max.  
 Contact Timing .....Make before break  
 Insulation Resistance .....100 Megohms min.  
 Dielectric Strength .....500 VAC  
 Actuation Force .....200 ± 150 Grams  
 Life Expectancy .....Up to 10,000 Cycles

**B**  
MMS Series

**SPDT**



MMS12

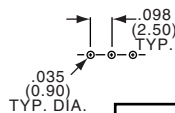
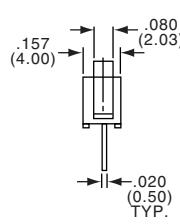
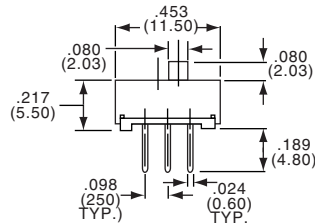

Circuit Diagram



Part Number				
Tyco Electronics	Alcoswitch	Type	Plating	Mounting Style
1437575-4	MMS12	SPDT	Silver	Upright

**DPDT**



MMS22

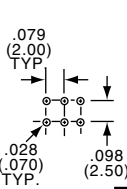
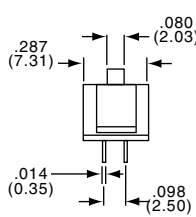
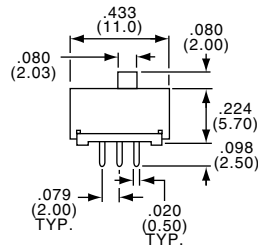

Circuit Diagram

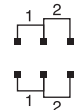

Part Number				
Tyco Electronics	Alcoswitch	Type	Plating	Mounting Style
1437575-5	MMS22	DPDT	Silver	Upright

**DPDT**



MMS22R

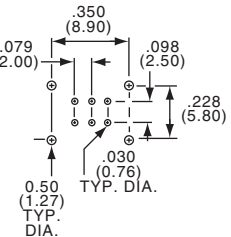
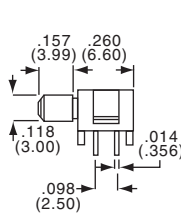
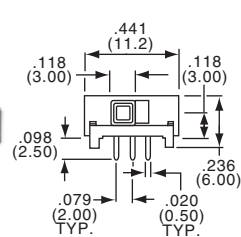

Circuit Diagram

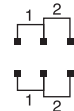

Part Number				
Tyco Electronics	Alcoswitch	Type	Plating	Mounting Style
1437575-6	MMS22R	DPDT	Silver	Right Angle

**DP3T**



MMS23

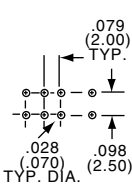
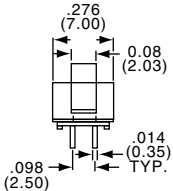
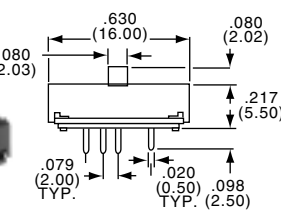

Circuit Diagram

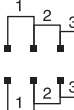

Part Number				
Tyco Electronics	Alcoswitch	Type	Plating	Mounting Style
1437575-8	MMS23	DP3T	Silver	Upright

**DP3T**



MMS23R

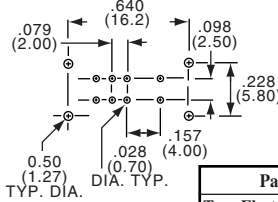
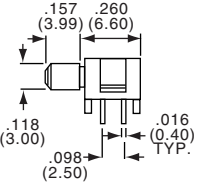
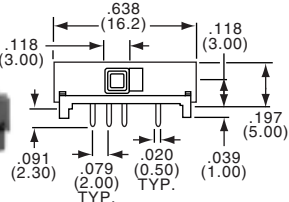

Circuit Diagram

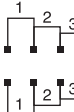

Part Number				
Tyco Electronics	Alcoswitch	Type	Plating	Mounting Style
1437575-9	MMS23R	DP3T	Silver	Right Angle

**Slide Switches, Micro Size, Instrumentation Grade**

SEE PAGE B36 FOR PRODUCT SPECIFICATIONS

**B**  
MMS Series

Circuit Diagram

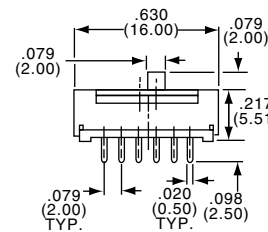
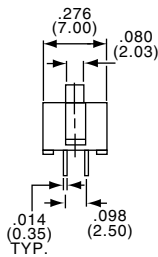
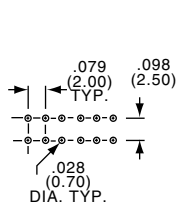
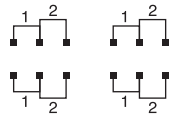

4PDT

MMS42

Part Number				
Tyco Electronics	Alcoswitch	Type	Plating	Mounting Style
I-1437575-0	MMS42	4PDT	Silver	Upright

Circuit Diagram

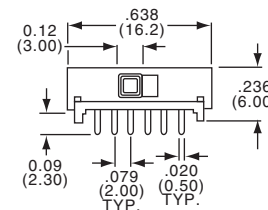
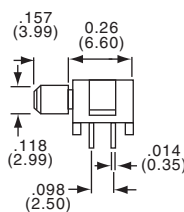
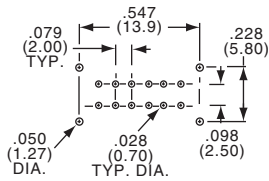
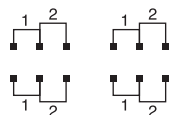

4PDT

MMS42R

Part Number				
Tyco Electronics	Alcoswitch	Type	Plating	Mounting Style
I-1437575-1	MMS42R	4PDT	Silver	Right Angle

Circuit Diagram

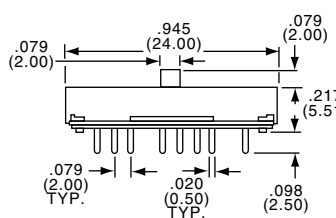
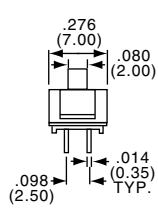
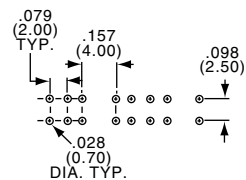
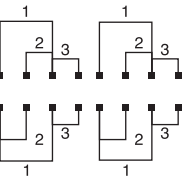

4P3T

MMS43

Part Number				
Tyco Electronics	Alcoswitch	Type	Plating	Mounting Style
I-1437575-2	MMS43	4P3T	Silver	Upright

Circuit Diagram

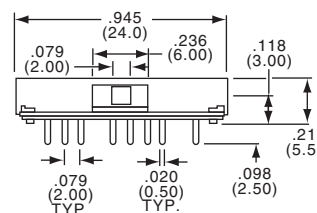
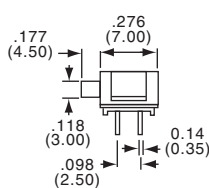
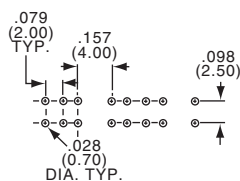
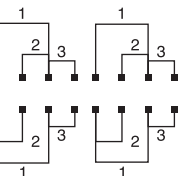

4P3T

MMS43R

Part Number				
Tyco Electronics	Alcoswitch	Type	Plating	Mounting Style
I-1437575-3	MMS43R	4P3T	Silver	Right Angle

**Slide Switches, Micro Size, Instrumentation Grade**

**MATERIAL SPECIFICATIONS:**

Contacts .....Gold or silver plate over nickel plate  
 Case Material .....Steel, tin plate  
 Actuator Material .....Polyacetal UL94HB  
 Terminals .....Gold or silver plate over nickel plate  
 Terminal Seal .....Epoxy

**ENVIRONMENTAL SPECIFICATIONS:**

Operating Temperature.....-4°F to +176°F (-20°C to +80°C)  
 Storage Temperature.....-40°F to +212°F (-40°C to +100°C)  
 Solder Heat Resistance.....+260°C (+500°F) for 5 seconds  
 per MIL-STD-202, Method 210

**TYPICAL PERFORMANCE CHARACTERISTICS:**

Contact Rating .....Gold: 0.4 VA @ 20 VDC or peak AC  
 Silver: 100 mA @ 30 VDC  
 Initial Contact Resistance.....30 Milliohms max.  
 Contact Timing.....Make before break  
 Insulation Resistance .....100 Megohms min.  
 Dielectric Strength .....500 VAC  
 Actuation Force .....250 ± 150 Grams  
 Life Expectancy .....Up to 10,000 Cycles  
 Travel .....0.079" (2.01)

**B**  
SSB Series

**SPDT**

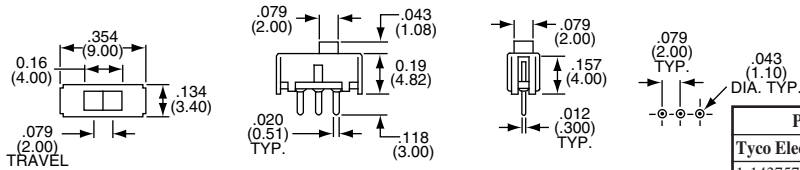

Circuit Diagram



Part Number				
Tyco Electronics	Alcoswitch	Type	Plating	Mounting Style
1-1437575-8	SSB12	SPDT	Silver	Upright
1-1437575-9	SSB12G	SPDT	Gold	Upright

**SPDT**

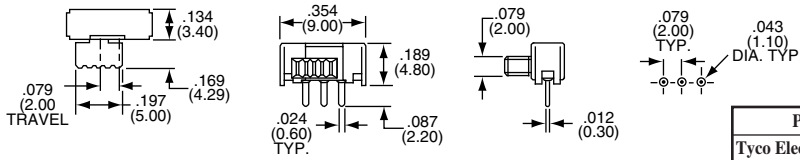

Circuit Diagram



Part Number				
Tyco Electronics	Alcoswitch	Type	Plating	Mounting Style
2-1437575-0	SSB12R	SPDT	Silver	Right Angle
2-1437575-1	SSB12RG	SPDT	Gold	Right Angle

**DPDT**

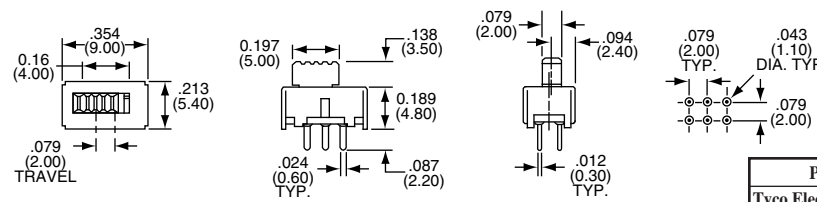

Circuit Diagram

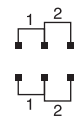

Part Number				
Tyco Electronics	Alcoswitch	Type	Plating	Mounting Style
2-1437575-2	SSB22	DPDT	Silver	Upright
2-1437575-3	SSB22G	DPDT	Gold	Upright

**DPDT**

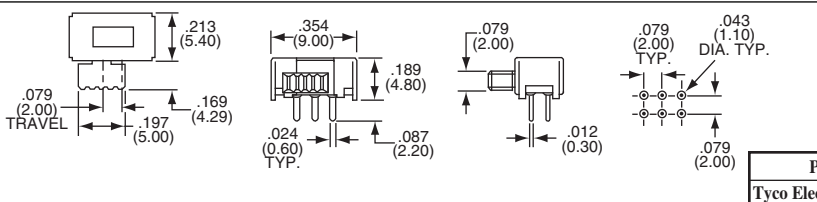

Circuit Diagram

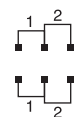

Part Number				
Tyco Electronics	Alcoswitch	Type	Plating	Mounting Style
2-1437575-4	SSB22R	DPDT	Silver	Right Angle
2-1437575-5	SSB22RG	DPDT	Gold	Right Angle

**4PDT**

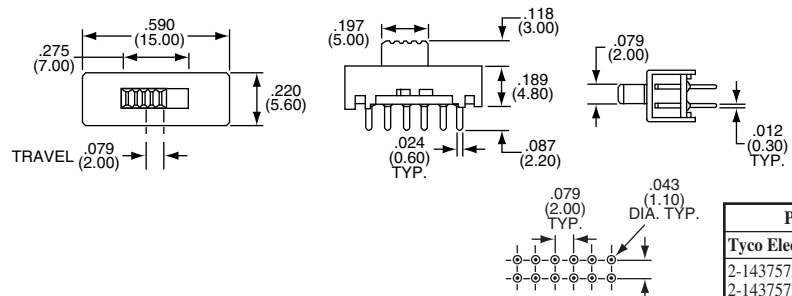

Circuit Diagram

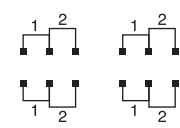

Part Number				
Tyco Electronics	Alcoswitch	Type	Plating	Mounting Style
2-1437575-8	SSB42	4PDT	Silver	Upright
2-1437575-9	SSB42G	4PDT	Gold	Upright

**Slide Switches, Micro Size, Instrumentation Grade**

**MATERIAL SPECIFICATIONS:**

Contacts .....Silver or gold plate  
 Case Material .....Polyester PPS UL94VO  
 Actuator Material .....Polyamide UL94HB  
 Cover Material .....Polyamide UL94HB  
 Terminals .....Silver or gold plate  
 Terminal Seal .....Epoxy

**ENVIRONMENTAL SPECIFICATIONS:**

Operating Temperature.....-4°F to +158°F (-20°C to +70°C)  
 Storage Temperature.....-40°F to +194°F (-40°C +90°C)  
 Solder Heat Resistance.....260°C (+500°F) for 5 seconds  
 per MIL-STD-202, Method 210

**TYPICAL PERFORMANCE CHARACTERISTICS:**

Contact Rating .....Gold: 0.4 VA max. @ 20 VDC or peak AC  
 Silver: 100 Milliamps @ 30 VDC  
 Initial Contact Resistance .....30 Milliohms max.  
 Contact Timing .....Break-Before-Make  
 Insulation Resistance .....100 Megohms min.  
 Dielectric Strength .....500 VAC  
 Actuation Force .....250 ± 100 Grams  
 Actuator Travel.....0.098" (2.49)  
 Life Expectancy .....Up to 10,000 Cycles

**B**  
SSA Series

**SPDT**

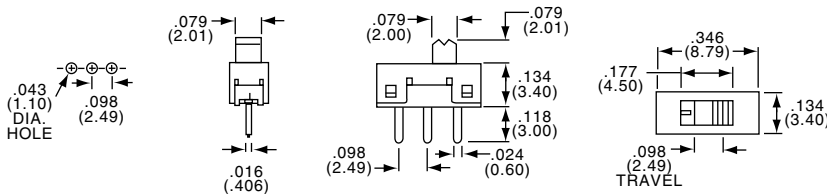

SSA12

Circuit Diagram



Part Number			
Tyco Electronics	Alcoswitch	Plating	Mounting Style
1-1437575-4	SSA12	Silver	Upright
1-1437575-5	SSA12G	Gold	Upright

**DPDT**

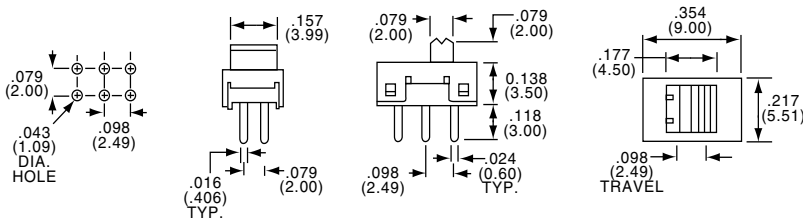

SSA22

Circuit Diagram

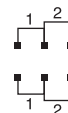

Part Number			
Tyco Electronics	Alcoswitch	Plating	Mounting Style
1-1437575-6	SSA22	Silver	Upright
1-1437575-7	SSA22G	Gold	Upright



**Slide Switches, PC Tails, Wiping Contact, Consumer Grade**

**MATERIAL SPECIFICATIONS:**

Contacts .....Silver plate over copper alloy  
 Case Material .....Steel  
 Actuator Material .....Polycarbonate  
 Terminals/Fixed Contacts.....Silver plate over copper alloy  
 Terminal Seal .....Epoxy

**TYPICAL PERFORMANCE CHARACTERISTICS:**

Contact Rating .....250 mA @ 125 VAC, 150 mA @ 12 VDC  
 Initial Contact Resistance .....30 Milliohms max.  
 Contact Timing .....Break before make  
 Insulation Resistance .....500 Megohms min.  
 Dielectric Strength .....500 VAC  
 Actuation Force .....100-300 Grams  
 Actuator Travel.....0.126" (3.20)  
 Life Expectancy .....Up to 10,000 Cycles

**ENVIRONMENTAL SPECIFICATIONS:**

Operating Temperature.....14°F to +140°F (-10°C to +60°C)  
 Storage Temperature.....14°F to +140°F (-10°C to +60°C)

**2 TO 6 POSITIONS**

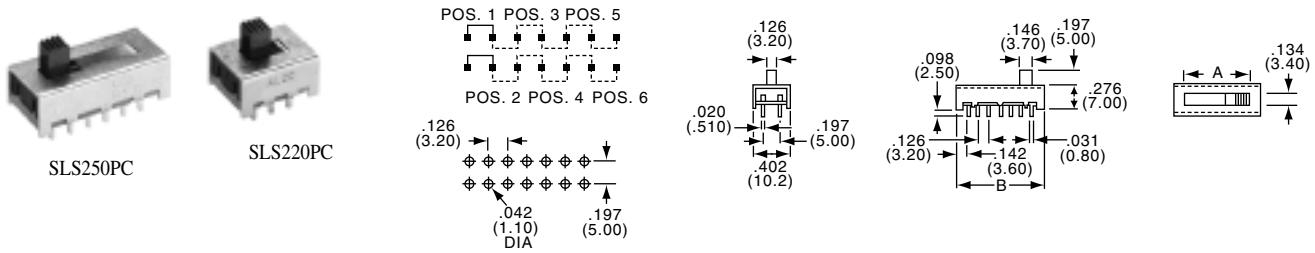

Part Number		Type	Dim.A	Dim.B
Tyco Electronics	Alcoswitch			
3-1437577-9	SLS220PC	2 Positions	.272(6.91)	.535(13.59)
4-1437577-1	SLS230PC	3 Positions	.398(10.11)	.661(16.79)
4-1437577-3	SLS240PCA	4 Positions	.524(13.31)	.787(19.99)
4-1437577-5	SLS250PC	5 Positions	.650(16.51)	.913(23.19)
4-1437577-7	SLS260PC	6 Positions	.776(19.71)	1.039(26.39)

**SL Series**

**Slide Switches, PC Tails, Lever or Knob Actuator**

**2 TO 10 POSITIONS**

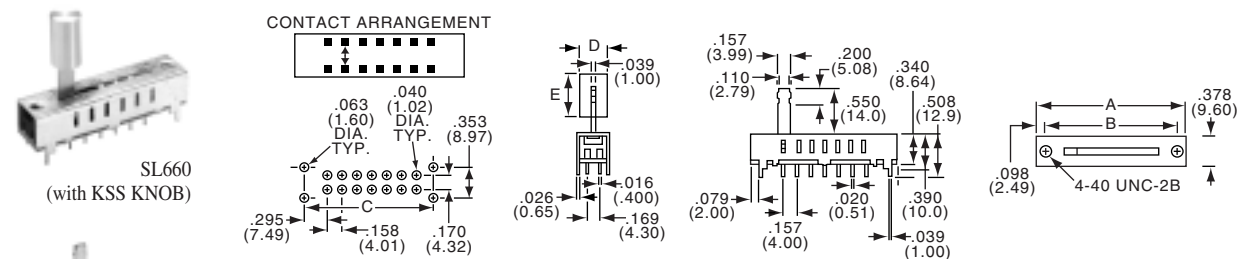

Part Number		Type	Dim. A	Dim. B	Dim. C	Knob Only	Description	Dim. D	Dim. E
Tyco Electronics	Alcoswitch								
1437577-9	SL220	2 Positions	.95(24.13)	.750(19.05)	.750(19.05)	KSS10A	Aluminum-Clear Anodize	.270(6.86)	.500(12.70)
1-1437577-0	SL330	3 Positions	1.11(28.19)	.910(23.1)	.910(23.1)	KSS10B	Aluminum-Black Anodize	.270(6.86)	.500(12.70)
1-1437577-1	SL550	5 Positions	1.42(36.07)	1.22(30.99)	1.22(31.1)	KSS20A	Aluminum-Clear Anodize	.305(7.75)	.512(13.00)
1-1437577-2	SL660	6 Positions	1.58(40.13)	1.38(35.05)	1.38(35.1)	KSS20B	Aluminum-Black Anodize	.305(7.75)	.512(13.00)
1-1437577-3	SL770	7 Positions	1.74(44.20)	1.54(39.12)	1.54(39.1)				
1-1437577-4	SL880	8 Positions	1.89(48.01)	1.70(43.18)	1.70(43.1)				
1437577-8	SL1000	10 Positions	2.21(56.13)	2.01(51.05)	2.01(51.5)				



**Slide Switches, Panel Mount, Wiping Contact, Consumer Grade**

**MATERIAL SPECIFICATIONS:**

Contacts .....Silver over nickel plate copper alloy  
 Case Material .....Steel-zinc plated  
 Actuator Material .....PBT 30% glass  
 Terminals/Fixed Contacts.....Silver over nickel plate copper alloy  
 Terminal Seal .....Epoxy

**ENVIRONMENTAL SPECIFICATIONS:**

Operating Temperature.....-4°F to +185°F (-20°C to +85°C)  
 Storage Temperature.....-40°F to +212°F (-40°C to +100°C)  
 Solder Heat Resistance .....+300°C (+572°F) for 5 seconds

**TYPICAL PERFORMANCE CHARACTERISTICS:**

Contact Rating .....500 mA @ 125 VAC, 200 mA @ 12 VDC  
 Initial Contact Resistance .....30 Milliohms max.  
 Contact Timing .....Break-Before-Make  
 Insulation Resistance .....500 Megohms min.  
 Dielectric Strength .....500 VAC  
 Actuation Force .....SLS: 100-300 Grams; SLSA: 220, 300 -500 Grams  
 Plunger/Actuator Travel: .....0.106" (2.69)  
 Life Expectancy .....Up to 10,000 Cycles

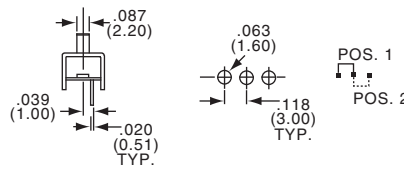
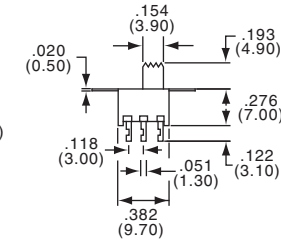
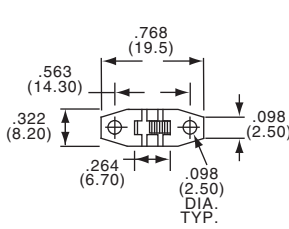

SPDT

SLS120

Part Number				
Tyco Electronics	Alcoswitch	Type	Mounting	Terminals Contacts
1-1437577-5	SLS120	SPDT	Panel	Lug

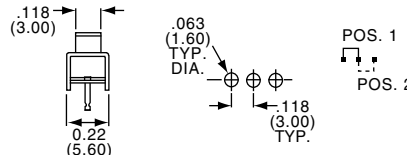
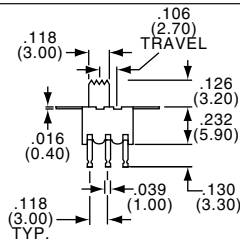
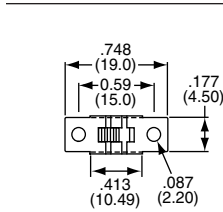

SPDT

SLSA120

Part Number				
Tyco Electronics	Alcoswitch	Type	Mounting	Terminals Contacts
5-1437577-3	SLSA120	SPDT	Panel	Turret

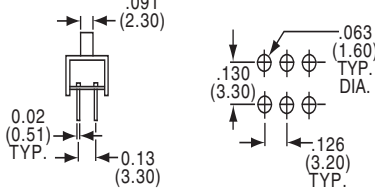
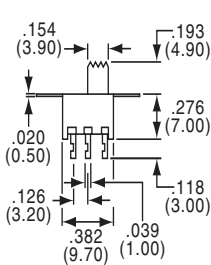
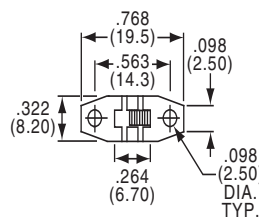

DPDT

SLS220

Part Number				
Tyco Electronics	Alcoswitch	Type	Mounting	Terminals Contacts
3-1437577-7	SLS220	DPDT	Panel	Lug

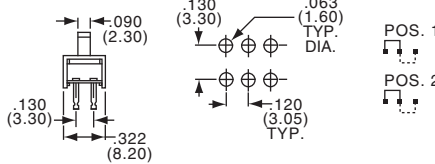
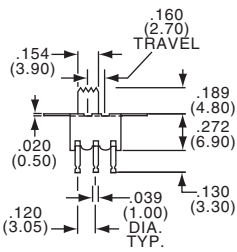
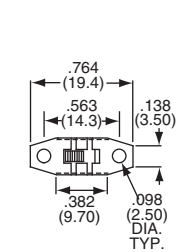

DPDT

SLSA220

Part Number				
Tyco Electronics	Alcoswitch	Type	Mounting	Terminals Contacts
5-1437577-5	SLSA220	DPDT	Panel	Turret

**Slide Switches, Wiping Contacts, Consumer Grade**

**MATERIAL SPECIFICATIONS:**

Contacts .....Copper alloy-silver/nickel  
 Case Material .....Steel-zinc plate  
 Actuator Material .....PBT 30% Glass  
 Terminals/Fixed Contacts.....Copper, alloy, silver/nickel plate  
 Terminal Seal .....Epoxy

**TYPICAL PERFORMANCE CHARACTERISTICS:**

Contact Rating .....500 mA @ 125 VAC, 200 mA @ 12 VDC  
 Initial Contact Resistance .....30 Milliohms max.  
 Contact Timing .....Break before make  
 Insulation Resistance .....500 Megohms min.  
 Dielectric Strength .....500 VAC  
 Actuation Force .....350±150 Grams  
 Plunger/Actuator Travel: .....0.106 (2.69)  
 Life Expectancy .....Up to 10,000 Cycles

**ENVIRONMENTAL SPECIFICATIONS:**

Operating Temperature.....-4°F to + 185°F (-20°C to + 85°C)  
 Storage Temperature.....-40°F to + 212°F (-40°C to + 100°C)  
 Solder Heat Resistance .....+300°C (+572°F) for 5 seconds

**SPDT**



Lug

SLS1201

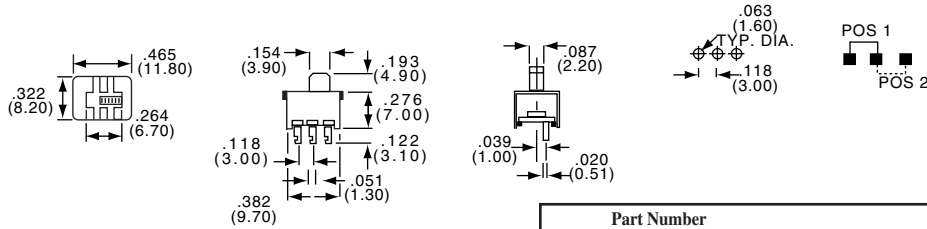

Part Number					
Tyco Electronics	Alcoswitch	Type	Mounting	Terminals	Contacts
1-1437577-6	SLS1201	SPDT	PC	Lug	

**DPDT**



Lug

SLS2201

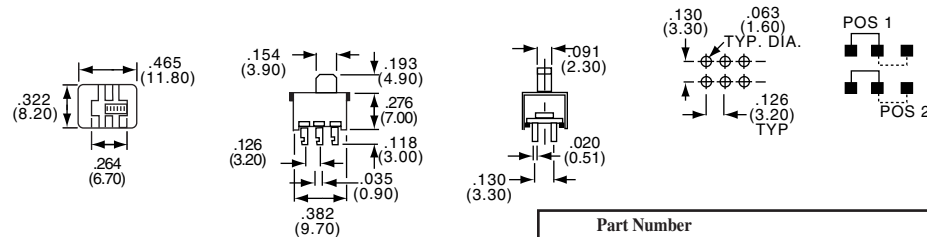

Part Number					
Tyco Electronics	Alcoswitch	Type	Mounting	Terminals	Contacts
3-1437577-8	SLS2201	DPDT	PC	Lug	

**SPDT**

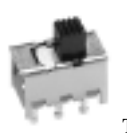

Turret

SLSA1201

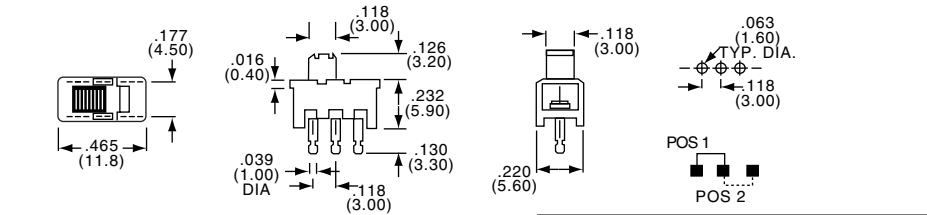

Part Number					
Tyco Electronics	Alcoswitch	Type	Mounting	Terminals	Contacts
5-1437577-4	SLSA1201	SPDT	PC	Turret	

**DPDT**



Turret

SLSA2201

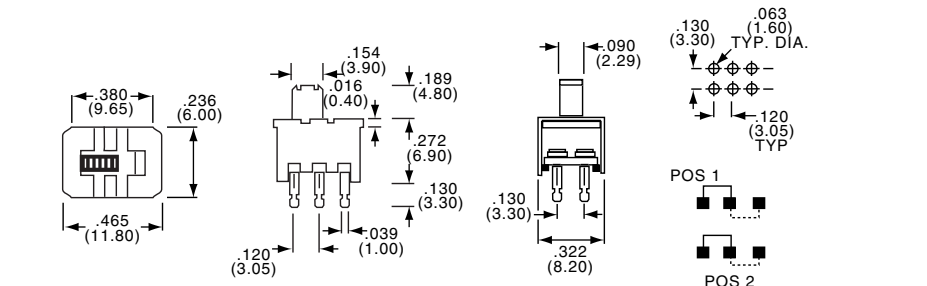

Part Number					
Tyco Electronics	Alcoswitch	Type	Mounting	Terminals	Contacts
5-1437577-6	SLSA2201	DPDT	PC	Turret	

**Slide Switches, Miniature, Rolling Contact, Economy Grade**

**MATERIAL SPECIFICATIONS:**

Contacts .....Silver over nickel plate over copper alloy  
Case Material .....Tin plate over steel  
Actuator Material .....Polycarbonate  
Terminals/Fixed Contacts.....Silver over nickel plate over copper alloy

**TYPICAL PERFORMANCE CHARACTERISTICS:**

Contact Rating .....250 mA @ 125 VAC, 150 mA @ 12 VDC  
Initial Contact Resistance .....30 Milliohms max.  
Contact Timing .....Break before make  
Insulation Resistance .....500 Megohms min.  
Dielectric Strength .....500 VAC  
Actuation Force .....340 ± 57 Grams  
Actuator Travel.....0.126" (3.20)  
Life Expectancy .....Up to 6,000 to 10,000 Cycles

**ENVIRONMENTAL SPECIFICATIONS:**

Operating Temperature.....14°F to +185°F (-10°C to +85°C)  
Storage Temperature.....14°F to +185°F (-10°C to +85°C)

**B**  
SLS Series

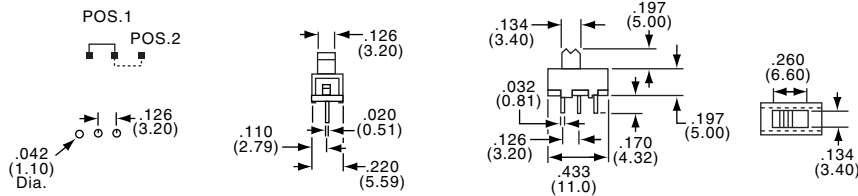

SPDT



SLS121PC

Part Number		
Tyco Electronics	Alcoswitch	Mounting Style
1-1437577-9	SLS121PC	Printed Circuit

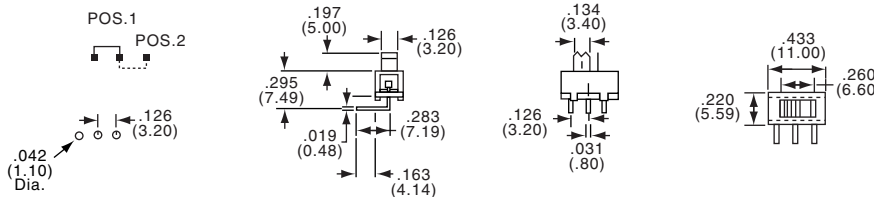

SPDT



SLS121RA

Part Number		
Tyco Electronics	Alcoswitch	Mounting Style
2-1437577-2	SLS121RA	Right Angle PC

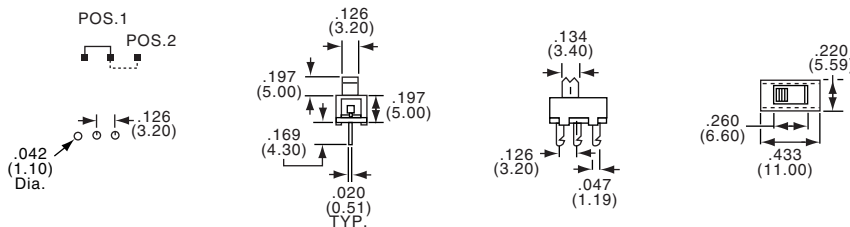

SPDT



SLS1211

Part Number		
Tyco Electronics	Alcoswitch	Mounting Style
1-1437577-8	SLS1211	Printed Circuit

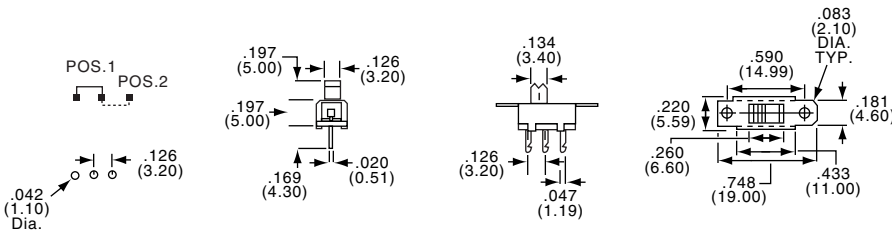

SPDT



SLS121

Part Number		
Tyco Electronics	Alcoswitch	Mounting Style
1-1437577-7	SLS121	Panel Mounted

**Slide Switches, Miniature, Rolling Contact, Economy Grade**

**MATERIAL SPECIFICATIONS:**

Contacts .....Silver over nickel flash over copper alloy  
 Case Material .....Steel  
 Actuator Material .....Polycarbonate  
 Terminals/Fixed Contacts.....Silver over nickel over copper alloy

**ENVIRONMENTAL SPECIFICATIONS:**

Operating Temperature.....+14°F to +185°F (-10°C to +85°C)  
 Storage Temperature.....+14°F to +185°F (-10°C to +85°C)  
 Solder Heat Resistance.....+260°C for 5 seconds

**TYPICAL PERFORMANCE CHARACTERISTICS:**

Contact Rating .....250mA @ 125 VAC  
 150mA @ 12VDC  
 Initial Contact Resistance .....20 Milliohms max.  
 Contact Timing .....Break-Before-Make  
 Insulation Resistance .....>50 Megohms.  
 Dielectric Strength .....500 Volts RMS @ sea level  
 Actuation Force .....340 ± 57 Grams  
 Plunger/Actuator Travel: .....0.260" to 0.512" (6.60-13.00)  
 Life Expectancy .....Up to 10,000 Cycles at no load

**B**  
SLS Series

**SP3T**

Part Number		
Tyco Electronics	Alcoswitch	Mounting Style
2-1437577-4	SLS131PC	Printed Circuit

**SP3T**

Part Number		
Tyco Electronics	Alcoswitch	Mounting Style
2-1437577-6	SLS131RA	Right Angle PC

**SP4T**

Part Number		
Tyco Electronics	Alcoswitch	Mounting Style
2-1437577-8	SLS141PC	Printed Circuit

**SP4T**

Part Number		
Tyco Electronics	Alcoswitch	Mounting Style
3-1437577-0	SLS141RA	Right Angle PC

**SP5T**

Part Number		
Tyco Electronics	Alcoswitch	Mounting Style
3-1437577-2	SLS151PC	Printed Circuit

**SP5T**

Part Number		
Tyco Electronics	Alcoswitch	Mounting Style
3-1437577-4	SLS151RA	Right Angle PC

B44

Catalog 1308390  
 Issued 9-04  
 www.tycoelectronics.com

Dimensions are in inches and millimeters unless otherwise specified. Values in parentheses or brackets are metric equivalents.

Dimensions are shown for reference purposes only. Specifications subject to change.

USA: 1-800-522-6752  
 Canada: 1-905-470-4425  
 Mexico: 01-800-733-8926  
 C. America: 52-55-5-729-0425

South America: 55-11-3611-1514  
 Hong Kong: 852-2735-1628  
 Japan: 81-44-844-8013  
 UK: 44-141-810-8967

**Slide Switches, Baton-Toggle, Multi Pole**

**MATERIAL SPECIFICATIONS:**

Contacts .....Silver clad over nickel plated copper alloy  
 Case Material .....Steel, tin plate  
 Actuator Material .....ABS plastic/Aluminum cap  
 Terminals/Fixed Contacts.....Silver over nickel plated copper alloy  
 Terminal Seal .....Epoxy

**ENVIRONMENTAL SPECIFICATIONS:**

Operating Temperature.....+5°F to +131°F (-15°C to +55°C)  
 Storage Temperature.....-4°F to +140° F (-20°C to +60°C)  
 Solder Heat Resistance.....Hand: 300°C for 3 seconds  
 Wave: 250°C for 5 seconds

**TYPICAL PERFORMANCE CHARACTERISTICS:**

Contact Rating .....300 mA @ 125 VAC, 200 mA @ 12VDC  
 Initial Contact Resistance .....20 Milliohms max.  
 Contact Timing .....See table below  
 Insulation Resistance .....500 Megohms min.  
 Dielectric Strength .....500 Volts RMS @ sea level  
 Actuation Force .....450 ± 250 Grams  
 Plunger/Actuator Travel .....30°  
 Life Expectancy .....Up to 10,000 Cycles

**B**  
CST Series

**DPDT**

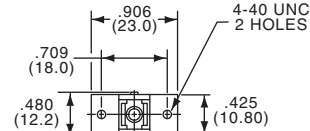
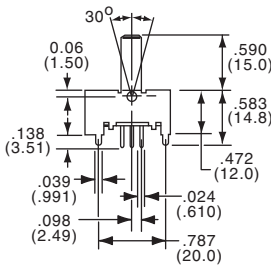
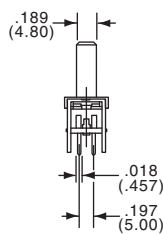
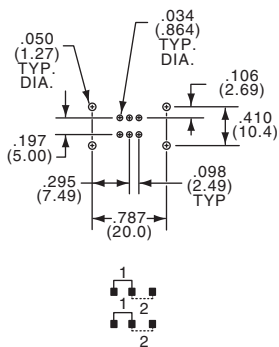

CST022NK

Part Number					Contact Timing
Tyco Electronics	Alcoswitch				
1437576-2	CST022NK	None	On	On	Non Shorting - Break-Before-Make (On) indicates momentary position.

**DP3T**

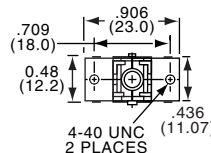
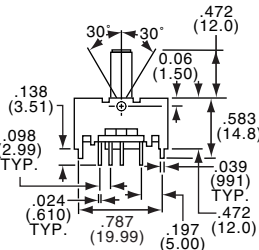
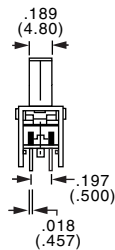
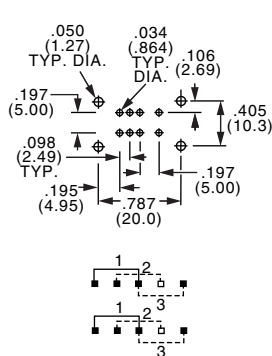

CST023NK

Part Number					Contact Timing
Tyco Electronics	Alcoswitch				
1437576-4	CST023NK	On	On	On	Non Shorting

**Slide Switches, Baton-Toggle, Multi Pole**

SEE PAGE B45 FOR PRODUCT SPECIFICATIONS

**B**  
CST Series

4PDT

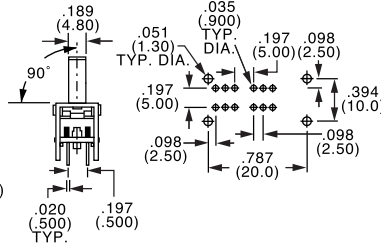
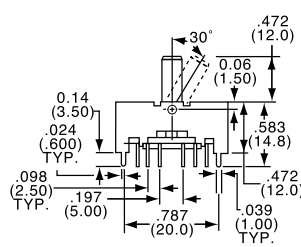
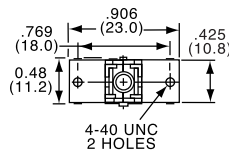

Circuit Diagram

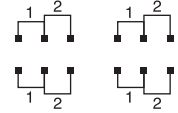

CST042NK

Part Number					
Tyco Electronics	Alcoswitch				Contact Timing
1437576-5	CST042NK	None	On	On	Non Shorting

4P3T

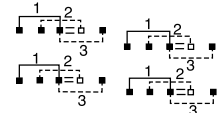
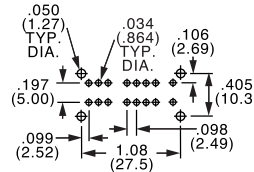
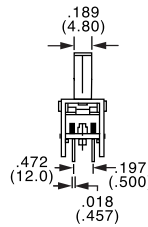
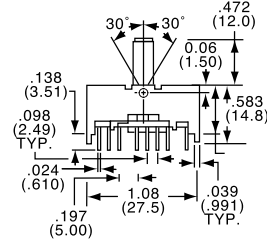
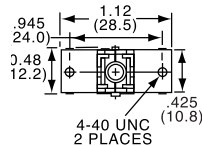

CST043NK

Part Number					
Tyco Electronics	Alcoswitch				Contact Timing
1437576-6	CST043NK	On	On	On	Non Shorting

6PDT

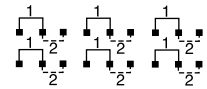
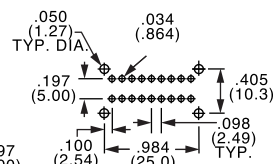
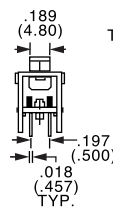
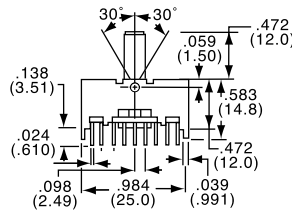
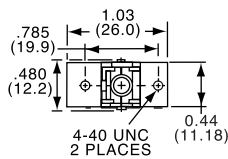

CST062NK

Part Number					
Tyco Electronics	Alcoswitch				Contact Timing
1437576-7	CST062NK	None	On	On	Non Shorting



**Slide Switches, Miniature, Right Angle, Surface Mount**

**MATERIAL SPECIFICATIONS:**

Contacts .....BeCu, copper alloy, 1 micron silver plate  
 Case Material .....40% G.F. PPS, UL94V-0  
 Frame.....Stainless steel, silver plated  
 Actuator Material .....Nylon, UL94HB polyamide  
 Terminals .....Brass, copper alloy, 1 micron silver plate  
 Terminal Seal.....Epoxy

**TYPICAL PERFORMANCE CHARACTERISTICS:**

Contact Rating .....0.3 Amp, 4 VDC  
 Initial Contact Resistance .....70 Milliohms  
 Insulation Resistance .....100 Megohms min.  
 Dielectric Strength .....100 VAC min.  
 Actuation Force .....175 ±100 Grams  
 Life Expectancy .....Up to 10,000 Cycles  
 Travel .....0.059 (1.5mm)

**ENVIRONMENTAL SPECIFICATIONS:**

Humidity .....MIL-STD-202, Method 103, Condition B  
 Moisture Resistance .....MIL-STD-202, Method 106  
 Thermal Shock .....MIL-STD-202, Method 107, Condition A  
 Solder Heat Resistance ...230°C per EIA 364-56 Level 2

**SPDT**

**CIRCUIT DIAGRAM**

MLL1200S

Part Number		
Tyco Electronics	Alcoswitch	Type
1437575-1	MLL1200S	SPDT
1437575-2	MLL1200STR	SPDT

**SP3T**

**CIRCUIT DIAGRAM**

MLL1300S

Part Number		
Tyco Electronics	Alcoswitch	Type
1437575-3	MLL1300S	SP3T