

C&K RTA Series 1-4 Poles Coded Rotary Switches

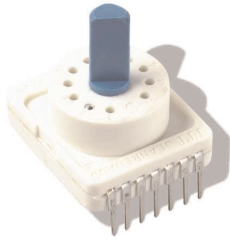

Features/Benefits

- PCB or hand soldering versions
- Bushing mounting
- Multiple poles
- Decimal and hexadecimal codes
- Screwdriver slot or extended actuator

Typical Applications

- Appliances
- Electronic alarm systems
- Medical
- Building automation
- HVAC air conditioning

Specifications

CONTACT RATING: 5 AMPS
 ELECTRICAL LIFE: 10,000 operations.
 OPERATING TORQUE: 5 Ncm±20%.
 END STOP TORQUE: > 6 Ncm.
 CONTACT RESISTANCE: < 150 mΩ
 INSULATION RESISTANCE: 10⁹ Ω
 DIELECTRIC STRENGTH: 500 V rms

NOTE: Specifications and materials listed above are for switches with standard options. For information on specific and custom switches, consult Customer Service Center.

Materials

HOUSING: PETP Thermoplastic
 STATIONARY CONTACTS & TERMINALS: Nickel alloy, gold or silver plated.
 ROTOR: Printed circuit, gold or silver plated.
 CODING PLATE: PA thermoplastic
 ACTUATOR: Polysulfon thermoplastic
 BUSHING: Washer: PA. Nut: Brass.
 HARDWARE: Stop pin: Aluminum. Ball & Spring: Stainless steel.

Build-A-Switch

To order, simply select desired option from each category and place in the appropriate box. Available options are shown and described on pages K-9 thru K-11. For additional options not shown in catalog, consult Customer Service Center.



Rotary



Designation
RTAP (STD.) With Pc pins
RTAC (STD.) With solder lugs

Indexing
22.5 (STD.) 22.5 index (coded only)
30 (STD.) 30° index (12 positions max.)
36 (STD.) 36° index (10 positions max.)

Switch Function
112S (STD.) SP, 30° Index, 12 pos. no stop
110S (STD.) SP, 36° Index, 10 pos. no stop
102B02 SP, 30° /36° Index, 2 pos.
103B03 SP, 30° /36° Index, 3 pos.
104B04 SP, 30° /36° Index, 4 pos.
105B05 SP, 30° Index, 5 pos.
106B06 SP, 30° /36° Index, 6 pos.
107B07 SP, 30° /36° Index, 7 pos.
108B08 SP, 30° /36° Index, 8 pos.
109B09 SP, 30° /36° Index, 9 pos.
110B10 (STD.) SP, 30° /36° Index, 10 pos.
111B11 SP, 30° Index, 11 pos.
112B12 (STD.) SP, 30° Index, 12 pos.
206S (STD.) DP, 30° Index, 6 pos. no stop
205S (STD.) DP, 36° Index, 5 pos. no stop
202B02 DP, 30° /36° Index, 2 pos.
203B03 DP, 30° /36° Index, 3 pos.
204B04 DP, 30° /36° Index, 4 pos.
205B05 DP, 30° /36° Index, 5 pos.
206B06 (STD.) DP, 30° Index, 6 pos.
303S 3P, 30° /36° Index, 3 pos. no stop
302B02 3P, 30° /36° Index, 2 pos.
303B03 3P, 30° /36° Index, 3 pos.
402S 4P, 30° /36° Index, 2 pos. no stop
402B02 4P, 30° /36° Index, 2 pos.

Mounting Style
SD (STD.) Without
AD (STD.) With

Actuator (max.)
25 (STD.) .984 (25,0)
50 1.97 (50,0)
F (STD.) Screwdriver slot
M25 Flat shaft, .984 (25,0)
M50 Flat shaft, 1.97 (50,0)

Contact Material
S (STD.) Silver plated
G Gold plated

BCS (STD.) Direct + complement, 30° /36° Index, no stop
BS (STD.) Direct, 22.5° Index, no stop
GS Gray, 22.5° Index, no stop
BCB Direct + complement, with stop (indicate position)
GB Gray, 22.5° Index, with stop (indicate position)
BB Direct, 22.5° Index, with stop (indicate position)

C&K RTA Series 1-4 Poles Coded Rotary Switches

DESIGNATION

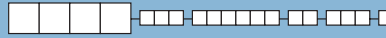

RTAP (STD.) WITH PC PINS

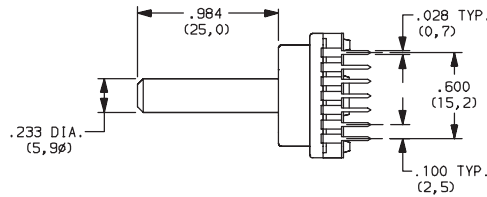
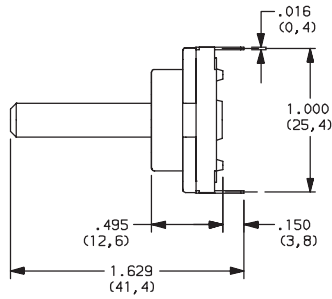
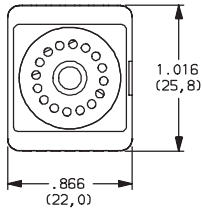

PART NUMBER	FUNCTION	INDEX
RTAP22.5BSSD25S	Binary	22.5
RTAP30112SSD25S	SP 12 positions no stop	30
RTAP36110SSD25S	SP 10 positions no stop	36

RTAC (STD.) WITH SOLDER LUGS

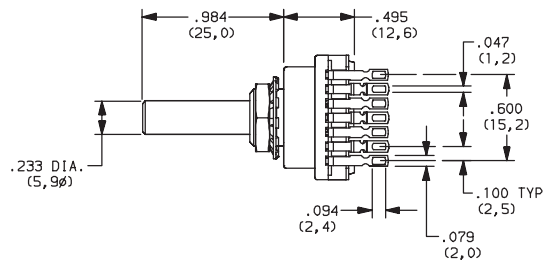
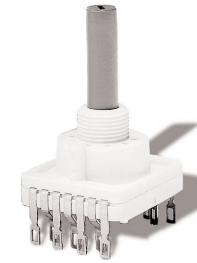
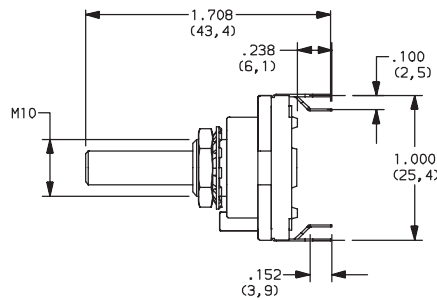
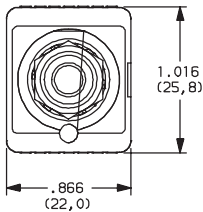

PART NUMBER	FUNCTION	INDEX
RTAC22.5BSAD25S	Binary	22.5
RTAC30112SAD25S	SP 12 positions no stop	30
RTAC36110SAD25S	SP 10 positions no stop	36

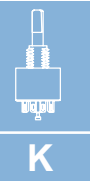

Rotary

INDEXING



22.5 (STD.) 22.5 index, 16 positions max.

30 (STD.) 30 index, 12 positions max.

36 (STD.) 36 index, 10 positions max.



Third Angle
Projection

Dimensions are shown: IN (mm)
Dimensions subject to change

C&K RTA Series 1-4 Poles Coded Rotary Switches

SWITCH FUNCTION

NO. POLES	MODEL NO.	SWITCH FUNCTION	INDEX
SP	112S	12 Positions No Stop	30°
	110S	10 Positions No Stop	36°
	102B02	2 Positions	30° / 36°
	103B03	3 Positions	30° / 36°
	104B04	4 Positions	30° / 36°
	105B05	5 Positions	30°
	106B06	6 Positions	30° / 36°
	107B07	7 Positions	30° / 36°
	108B08	8 Positions	30° / 36°
	109B09	9 Positions	30° / 36°
	110B10	10 Positions	30° / 36°
	111B11	11 Positions	30°
112B12	12 Positions	30°	

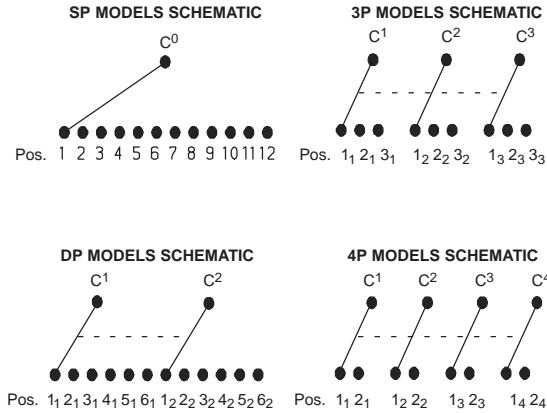

NO. POLES	MODEL NO.	SWITCH FUNCTION	INDEX
DP	206S	6 Positions No Stop	30°
	205S	5 Position No Stop	36°
	202B02	2 Positions	30° / 36°
	203B03	3 Positions	30° / 36°
	204B04	4 Positions	30° / 36°
	205B05	5 Positions	30° / 36°
	206B06	6 Positions	30°
3P	303S	3 Positions No Stop	30° / 36°
	302B02	2 Positions	30° / 36°
	303B03	3 Positions	30° / 36°
4P	402S	3 Positions No Stop	30° / 36°
	402B02	2 Positions	30° / 36°

22.5°	30°	36°		Pos.	1	2	3	4	5	6	7	8	9	10	11	12	13	14	15	16	
Term. E,J	Term. L,N	Term. M,N		C
F,I	D	H	1	
D,K	B	D	2		
A,N	I	A	4			
B	J	J	8									
—	K	C	1
—	H	K	2				
—	A	B	4				
—	C	I	8				

30 INDEXING ANGLE PCB LAYOUT

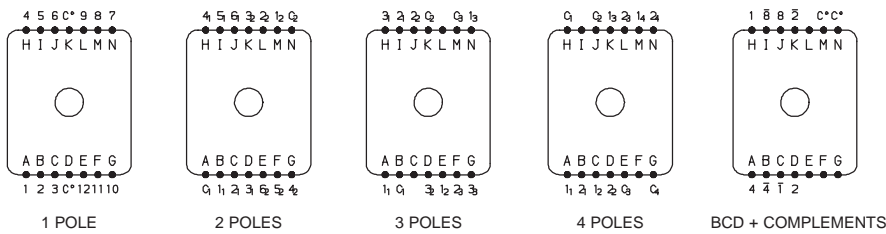

22.5 INDEXING ANGLE PCB LAYOUT

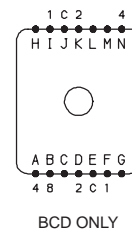

36 INDEXING ANGLE PCB LAYOUT

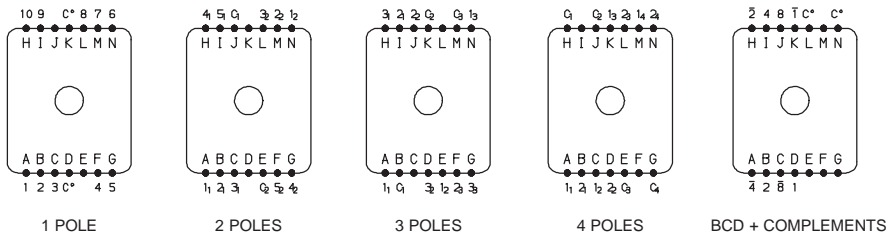

NOTE: Layout view from component side.

C&K RTA Series 1-4 Poles Coded Rotary Switches

MOUNTING STYLE

SD (STD.) WITHOUT BUSHING

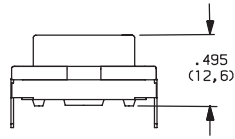

AD (STD.) WITH BUSHING

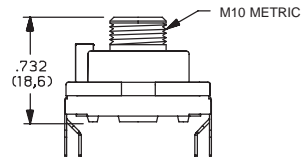

PANEL MOUNTING

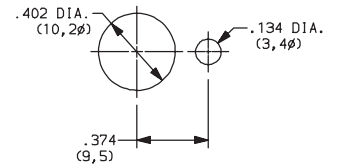

ACTUATOR

25 (STD.) 0,25 mm (.984)

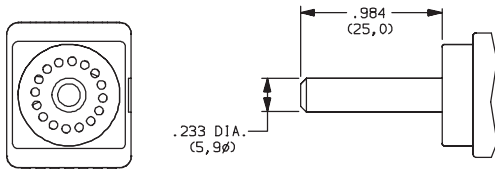

50 0,50 mm (1.97)

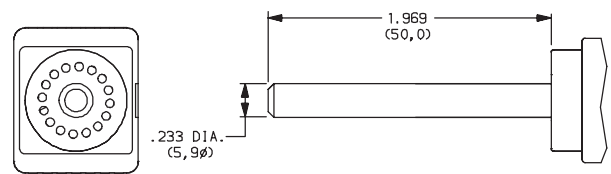

F (STD.) SCREWDRIWER SLOT

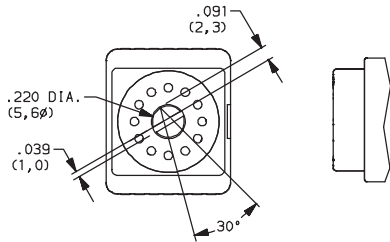

M25 FLAT SHAFT

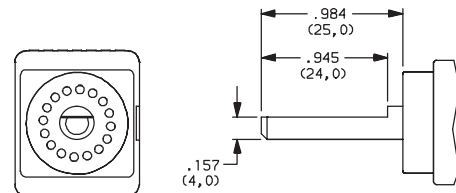

M50 FLAT SHAFT

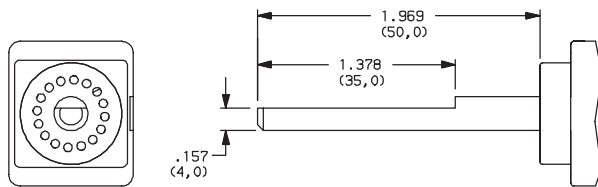

CONTACT MATERIAL

OPTION CODE	CONTACT AND TERMINAL MATERIAL	RATINGS	
S (STD.)	SILVER	LOW LEVEL/DRY CIRCUIT	SWITCH: 150 mA maximum, 60 V nominal. POWER: 5 VA maximum. CARRY: 5 AMPS maximum.
G	GOLD	LOW LEVEL/DRY CIRCUIT OR POWER	SWITCH: 20 mA maximum, 25 V nominal. POWER: 0.5 VA maximum. CARRY: 1 AMP maximum.



Dimensions are shown: IN (mm)
Dimensions subject to change