

CONTACT CONFIGURATION
TIMING (BBM) NON-SHORTING

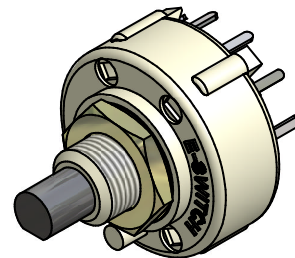

ISOMETRIC

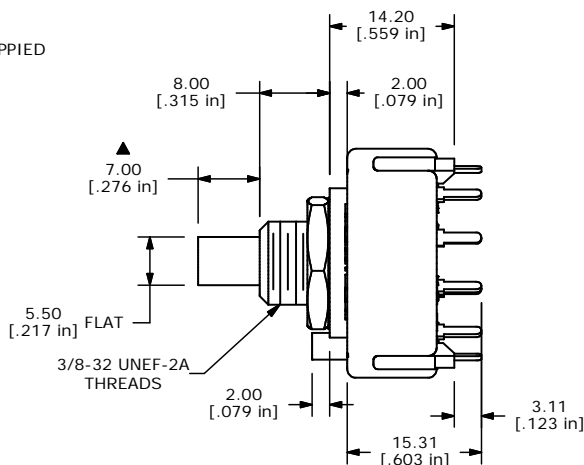
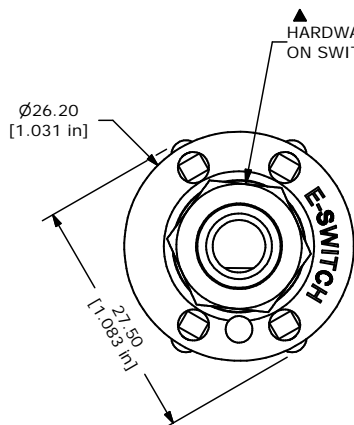
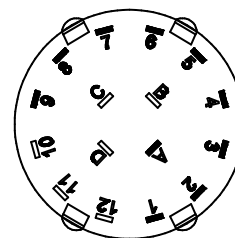

NOTE:

1. ALL DIMENSIONS IN MM[INCH].
2. GENERAL TOLERANCE: X.X=±0.4
X.XX=±0.25
3. TERM. NOS. FOR REFERENCE ONLY.
- ▲ 4. CONTACT MATERIAL: SILVER
5. CONTACT RATING: 150MILLIAMP, 250VAC/DC
350MILLIAMP, 110VAC/DC
6. CONTACT RATING (NON-SWITCHING) 5A
7. OPERATING FORCE 425±100CM/STANDARD
8. OPERATING TEMP: -30°C TO 85°C
- ▲ 9. CIRCUIT SP: 9 POSITION 30° INDEX.
10. DIELECTRIC STRENGTH: 1000V RMS MIN.@ SEA LEVEL.
- ▲ 11. HARDWARE SUPPLIED ON SWITCH:
LOCKWASHER, HEXNUT, STOP RING
12. ▲DENOTES CRITICAL PARAMETER.

E-SWITCH®

TITLE KC19A7.001NPS

A	13792	RELEASED FOR PRODUCTION	2/20/04	AR
REV	PCR NO	DESCRIPTION	DATE	BY

THE INFORMATION CONTAINED IN THIS DOCUMENT IS PROPRIETARY TO E-SWITCH AND IS NOT TO BE COPIED OR TRANSFERRED

SCALE	DATE	DR	DWG	REV
1.5:1	2/20/04	AR	G510575	A