

THIS INFORMATION IS CONFIDENTIAL AND PROPRIETARY TO CW INDUSTRIES INCORPORATED AND ITS AFFILIATES. IT MAY NOT BE DISCLOSED TO ANYONE, OTHER THAN CW INDUSTRIES PERSONNEL, WITHOUT WRITTEN AUTHORIZATION FROM CW INDUSTRIES INCORPORATED, SOUTHAMPTON, PENNSYLVANIA USA.

Rating	20A 125VAC 3/4HP 125VAC		Mounting Hole	Circuit Diagram												
Contact Resistance	50m ohm Max.															
Insulation Resistance	DC 500V 100M ohm Min.															
Dielectric Strength	AC 1500V 1 minute															
Operation Temperature	-20°C~85°C		<table border="1"> <tr> <th>Thickness</th> <th>X</th> <th>Y</th> </tr> <tr> <td>0.75~1.25</td> <td>21.2+0.1</td> <td>36.6+0.1</td> </tr> <tr> <td>1.25~2</td> <td>21.2+0.1</td> <td>36.8+0.1</td> </tr> <tr> <td>2~3</td> <td>21.2+0.1</td> <td>37.0+0.1</td> </tr> </table>		Thickness	X	Y	0.75~1.25	21.2+0.1	36.6+0.1	1.25~2	21.2+0.1	36.8+0.1	2~3	21.2+0.1	37.0+0.1
Thickness	X	Y														
0.75~1.25	21.2+0.1	36.6+0.1														
1.25~2	21.2+0.1	36.8+0.1														
2~3	21.2+0.1	37.0+0.1														
Switch Function	3P SPDT ON-OFF-ON															

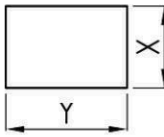

Material:
 Frame: Black, Nylon#66
 Actuator: Black, Nylon#66+30%GF
Waterproof: IP66

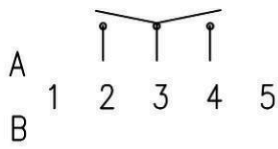
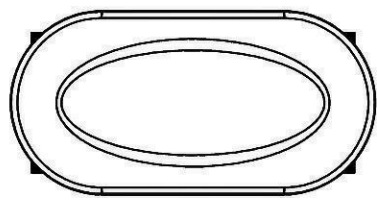
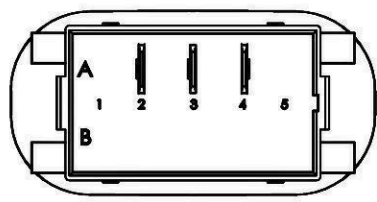
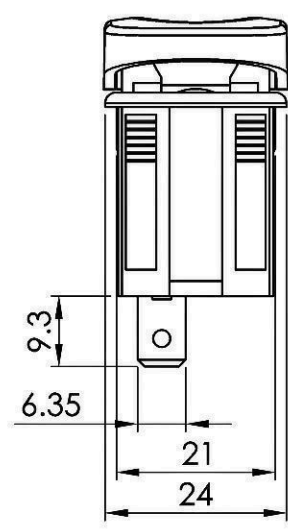
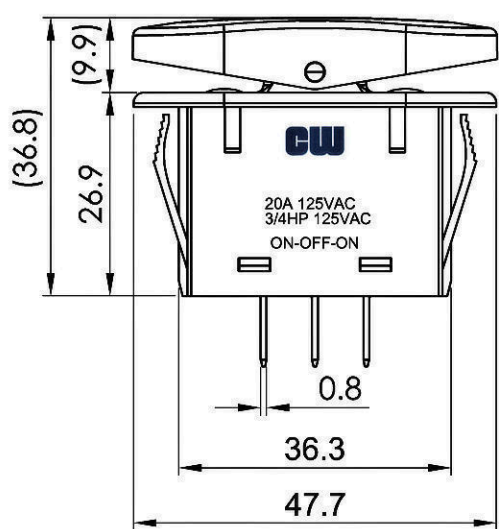

RoHS Compliant

TOLERANCE: ±0.3mm(±0.0012inch) UNLESS OTHERWISE SPECIFIED.

CW INDUSTRIES
 Southampton, Pa. 18966
 Tel 215.355.7080/www.cwind.com

Date Drawn: 3/12/09	Rev. 0	Unit: mm	Checked By: GG
Title: ROCKER SWITCH		CW P/N: GRB271D1BBNN1NN	