

### Dual IGBTMOD™ H-Series Module 200 Amperes/1200 Volts

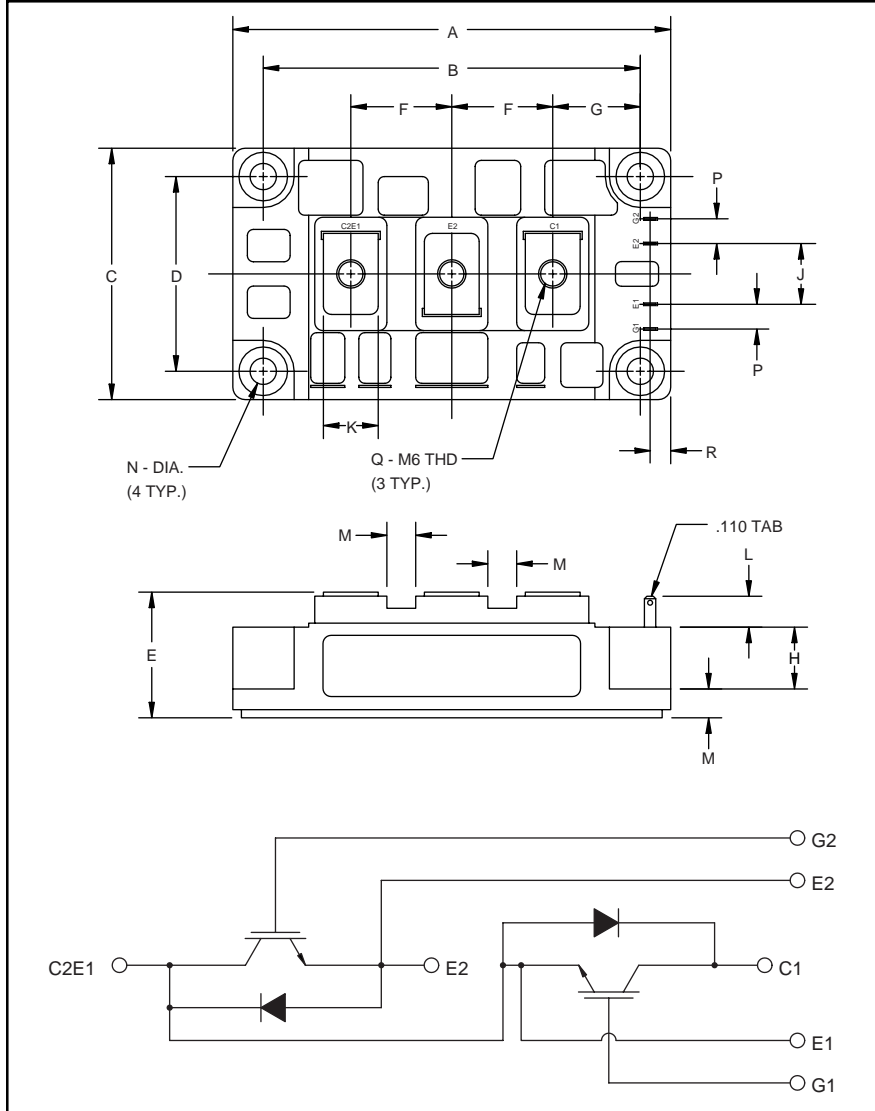

Outline Drawing and Circuit Diagram

Dimensions	Inches	Millimeters
A	4.25	108.0
B	3.66±0.01	93.0±0.25
C	2.44	62.0
D	1.89±0.01	48.0±0.25
E	1.22 Max.	31.0 Max.
F	0.98	25.0
G	0.85	21.5
H	0.60	15.2

Dimensions	Inches	Millimeters
J	0.59	15.0
K	0.55	14.0
L	0.30	8.5
M	0.28	7.0
N	0.256 Dia.	Dia. 6.5
P	0.24	6.0
Q	M6 Metric	M6
R	0.20	5.0



#### Description:

Powerex IGBTMOD™ Modules are designed for use in switching applications. Each module consists of two IGBT transistors in a half-bridge configuration with each transistor having a reverse-connected super-fast recovery free-wheel diode. All components and interconnects are isolated from the heat sinking baseplate, offering simplified system assembly and thermal management.

#### Features:

- Low Drive Power
- Low  $V_{CE(sat)}$
- Discrete Super-Fast Recovery (135ns) Free-Wheel Diode
- High Frequency Operation (20-25kHz)
- Isolated Baseplate for Easy Heat Sinking

#### Applications:

- AC Motor Control
- Motion/Servo Control
- UPS
- Welding Power Supplies
- Laser Power Supplies

#### Ordering Information:

Example: Select the complete part module number you desire from the table below -i.e. CM200DY-24H is a 1200V ( $V_{CES}$ ), 200 Ampere Dual IGBTMOD™ Power Module.

Type	Current Rating Amperes	$V_{CES}$ Volts (x 50)
CM	200	24

**CM200DY-24H**  
**Dual IGBTMOD™ H-Series Module**  
 200 Amperes/1200 Volts

**Absolute Maximum Ratings,  $T_j = 25\text{ }^\circ\text{C}$  unless otherwise specified**

Ratings	Symbol	CM200DY-24H	Units
Junction Temperature	$T_j$	-40 to 150	$^\circ\text{C}$
Storage Temperature	$T_{\text{stg}}$	-40 to 125	$^\circ\text{C}$
Collector-Emitter Voltage (G-E SHORT)	$V_{\text{CES}}$	1200	Volts
Gate-Emitter Voltage	$V_{\text{GES}}$	$\pm 20$	Volts
Collector Current	$I_{\text{C}}$	200	Amperes
Peak Collector Current	$I_{\text{CM}}$	400*	Amperes
Diode Forward Current	$I_{\text{F}}$	200	Amperes
Diode Forward Surge Current	$I_{\text{FM}}$	400*	Amperes
Power Dissipation	$P_{\text{d}}$	1500	Watts
Max. Mounting Torque M6 Terminal Screws	-	26	in-lb
Max. Mounting Torque M6 Mounting Screws	-	26	in-lb
Module Weight (Typical)	-	400	Grams
V Isolation	$V_{\text{RMS}}$	2500	Volts

\* Pulse width and repetition rate should be such that device junction temperature does not exceed the device rating.

**Static Electrical Characteristics,  $T_j = 25\text{ }^\circ\text{C}$  unless otherwise specified**

Characteristics	Symbol	Test Conditions	Min.	Typ.	Max.	Units
Collector-Cutoff Current	$I_{\text{CES}}$	$V_{\text{CE}} = V_{\text{CES}}, V_{\text{GE}} = 0\text{V}$	-	-	1.0	mA
Gate Leakage Current	$I_{\text{GES}}$	$V_{\text{GE}} = V_{\text{GES}}, V_{\text{CE}} = 0\text{V}$	-	-	0.5	$\mu\text{A}$
Gate-Emitter Threshold Voltage	$V_{\text{GE(th)}}$	$I_{\text{C}} = 20\text{mA}, V_{\text{CE}} = 10\text{V}$	4.5	6.0	7.5	Volts
Collector-Emitter Saturation Voltage	$V_{\text{CE(sat)}}$	$I_{\text{C}} = 200\text{A}, V_{\text{GE}} = 15\text{V}$	-	2.5	3.4**	Volts
		$I_{\text{C}} = 200\text{A}, V_{\text{GE}} = 15\text{V}, T_j = 150\text{ }^\circ\text{C}$	-	2.25	-	Volts
Total Gate Charge	$Q_{\text{G}}$	$V_{\text{CC}} = 600\text{V}, I_{\text{C}} = 200\text{A}, V_{\text{GS}} = 15\text{V}$	-	1000	-	nC
Diode Forward Voltage	$V_{\text{FM}}$	$I_{\text{E}} = 200\text{A}, V_{\text{GS}} = 0\text{V}$	-	-	3.5	Volts

\*\* Pulse width and repetition rate should be such that device junction temperature rise is negligible.

**Dynamic Electrical Characteristics,  $T_j = 25\text{ }^\circ\text{C}$  unless otherwise specified**

Characteristics	Symbol	Test Conditions	Min.	Typ.	Max.	Units
Input Capacitance	$C_{\text{ies}}$		-	-	40	nF
Output Capacitance	$C_{\text{Oes}}$	$V_{\text{GE}} = 0\text{V}, V_{\text{CE}} = 10\text{V}, f = 1\text{MHz}$	-	-	14	nF
Reverse Transfer Capacitance	$C_{\text{res}}$		-	-	8	nF
Resistive	Turn-on Delay Time	$t_{\text{d(on)}}$	-	-	250	ns
	Rise Time	$t_{\text{r}}$	-	-	400	ns
Switching	Turn-off Delay Time	$t_{\text{d(off)}}$	-	-	300	ns
	Fall Time	$t_{\text{f}}$	-	-	350	ns
Diode Reverse Recovery Time	$t_{\text{rr}}$	$I_{\text{E}} = 200\text{A}, di_{\text{E}}/dt = -400\text{A}/\mu\text{s}$	-	-	250	ns
Diode Reverse Recovery Charge	$Q_{\text{rr}}$	$I_{\text{E}} = 200\text{A}, di_{\text{E}}/dt = -400\text{A}/\mu\text{s}$	-	1.49	-	$\mu\text{C}$

**Thermal and Mechanical Characteristics,  $T_j = 25\text{ }^\circ\text{C}$  unless otherwise specified**

Characteristics	Symbol	Test Conditions	Min.	Typ.	Max.	Units
Thermal Resistance, Junction to Case	$R_{\text{th(j-c)}}$	Per IGBT	-	-	0.085	$^\circ\text{C}/\text{W}$
Thermal Resistance, Junction to Case	$R_{\text{th(j-c)}}$	Per FWDi	-	-	0.18	$^\circ\text{C}/\text{W}$
Contact Thermal Resistance	$R_{\text{th(c-f)}}$	Per Module, Thermal Grease Applied	-	-	0.045	$^\circ\text{C}/\text{W}$

**CM200DY-24H**  
**Dual IGBTMOD™ H-Series Module**  
 200 Amperes/1200 Volts

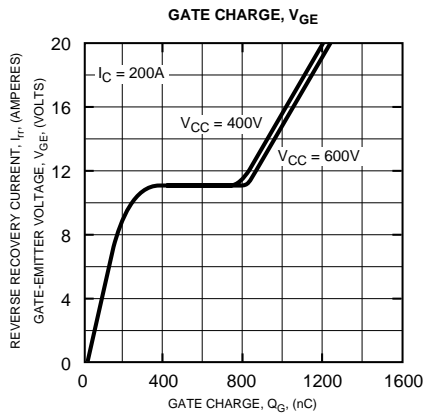
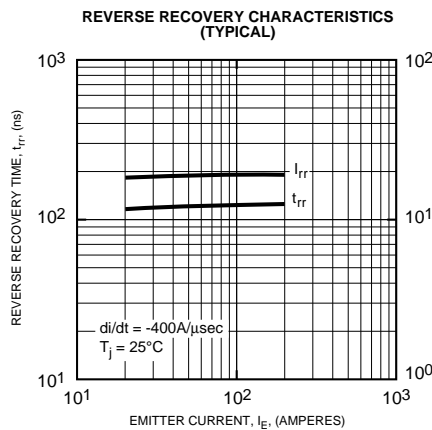
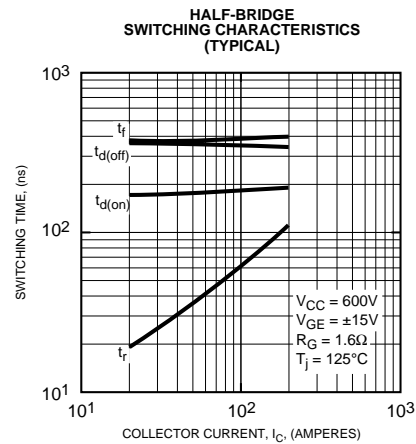
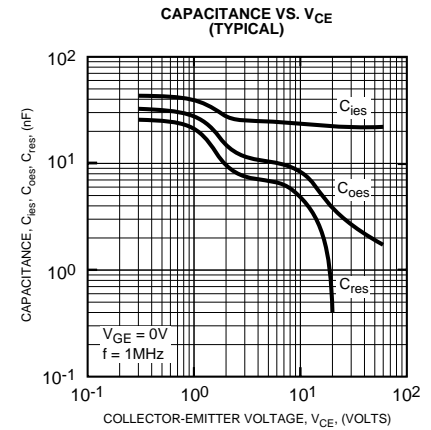
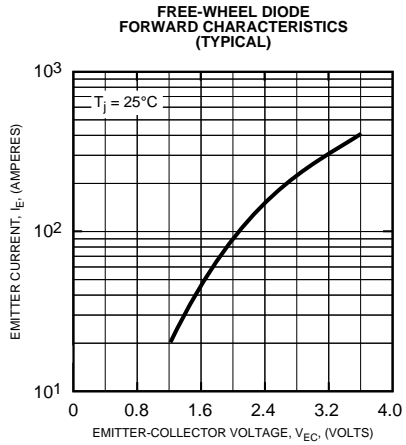
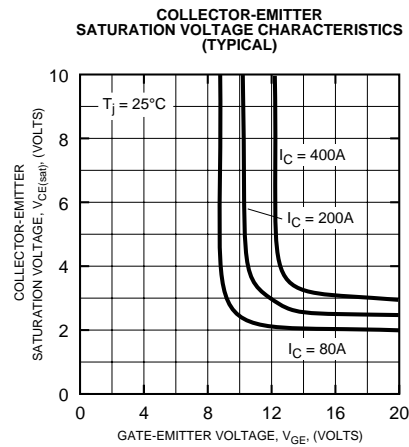
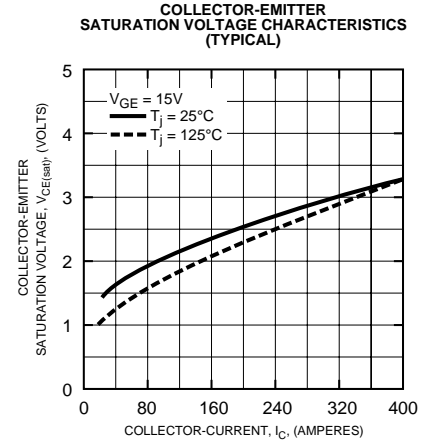
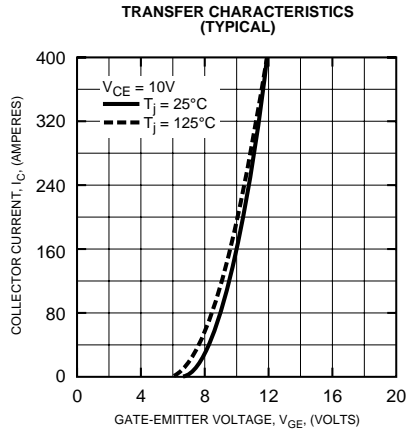
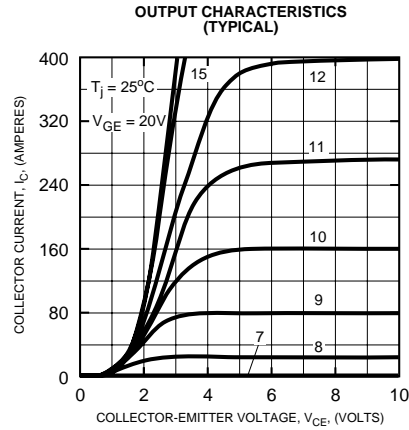

**CM200DY-24H**  
**Dual IGBTMOD™ H-Series Module**  
 200 Amperes/1200 Volts

