

Six-Pack Trench IGBT

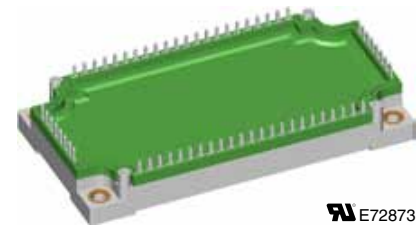
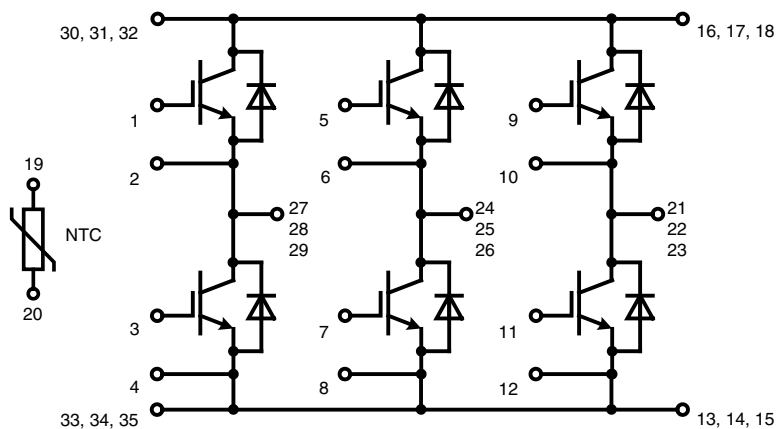
$$V_{CES} = 1200 \text{ V}$$

$$I_{C25} = 145 \text{ A}$$

$$V_{CE(sat)} = 1.7 \text{ V}$$

Part name (Marking on product)

MWI100-12T8T



Pin configuration see outlines.

Features:

- Trench IGBT technology
- low saturation voltage
- low switching losses
- square RBSOA, no latch up
- high short circuit capability
- positive temperature coefficient for easy paralleling
- MOS input, voltage controlled
- ultra fast free wheeling diodes
- solderable pins for PCB mounting
- package with copper base plate

Application:

- AC motor drives
- Solar inverter
- Medical equipment
- Uninterruptible power supply
- Air-conditioning systems
- Welding equipment
- Switched-mode and resonant-mode power supplies

Package:

- "E3-Pack" standard outline
- Insulated copper base plate
- Soldering pins for PCB mounting
- Temperature sense included

Output Inverter T1 - T6

Symbol	Definitions	Conditions	Ratings			Unit
			min.	typ.	max.	
V_{CES}	collector emitter voltage				1200	V
V_{GES}	max. DC gate voltage	continuous			±20	V
V_{GEM}	max. transient collector gate voltage	transient			±30	V
I_{C25}	collector current				145	A
I_{C80}					100	A
P_{tot}	total power dissipation				480	W
$V_{CE(sat)}$	collector emitter saturation voltage	$I_C = 100\text{ A}; V_{GE} = 15\text{ V}$		1.7	2.1	V
				2.0		V
$V_{GE(th)}$	gate emitter threshold voltage	$I_C = 4\text{ mA}; V_{GE} = V_{CE}$		5.0	6.5	V
I_{CES}	collector emitter leakage current	$V_{CE} = V_{CES}; V_{GE} = 0\text{ V}$			4	mA
				1		mA
I_{GES}	gate emitter leakage current	$V_{GE} = \pm 20\text{ V}$			500	nA
C_{ies}	input capacitance	$V_{CE} = 25\text{ V}; V_{GE} = 0\text{ V}; f = 1\text{ MHz}$		7210		pF
$Q_{G(on)}$	total gate charge	$V_{CE} = 600\text{ V}; V_{GE} = 15\text{ V}; I_C = 100\text{ A}$		550		nC
$t_{d(on)}$	turn-on delay time	inductive load $V_{CE} = 600\text{ V}; I_C = 100\text{ A}$ $V_{GE} = \pm 15\text{ V}; R_G = 3.9\ \Omega$	$T_{VJ} = 125^\circ\text{C}$		270	ns
t_r	current rise time				50	ns
$t_{d(off)}$	turn-off delay time				400	ns
t_f	current fall time				340	ns
E_{on}	turn-on energy per pulse				8.5	mJ
E_{off}	turn-off energy per pulse				13.5	mJ
RBSOA	reverse bias safe operating area	$V_{GE} = \pm 15\text{ V}; R_G = 3.9\ \Omega;$			200	A
			$T_{VJ} = 125^\circ\text{C}$ $V_{CEK} = 1200\text{ V}$			
SCSOA	short circuit safe operating area					
t_{SC}	short circuit duration	$V_{CE} = 900\text{ V}; V_{GE} = \pm 15\text{ V};$	$T_{VJ} = 125^\circ\text{C}$		10	μs
I_{SC}	short circuit current	$R_G = 3.9\ \Omega; \text{non-repetitive}$		400		A
R_{thJC}	thermal resistance junction to case	(per IGBT)			0.26	K/W

Output Inverter D1 - D6

Symbol	Definitions	Conditions	Ratings			Unit
			min.	typ.	max.	
V_{RRM}	max. repetitive reverse voltage				1200	V
I_{F25}	forward current				135	A
I_{F80}					90	A
V_F	forward voltage	$I_F = 100\text{ A}; V_{GE} = 0\text{ V}$		1.95	2.2	V
				1.95		V
Q_{rr}	reverse recovery charge	$V_R = 600\text{ V}$ $di_F/dt = -1600\text{ A}/\mu\text{s}$ $I_F = 100\text{ A}; V_{GE} = 0\text{ V}$	$T_{VJ} = 125^\circ\text{C}$		12.5	μC
I_{RM}	max. reverse recovery current				100	A
t_{rr}	reverse recovery time				350	ns
E_{rec}	reverse recovery energy				4	mJ
R_{thJC}	thermal resistance junction to case	(per diode)			0.4	K/W

 $T_C = 25^\circ\text{C}$ unless otherwise stated

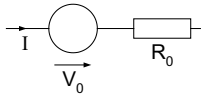
Temperature Sensor NTC

Symbol	Definitions	Conditions	Ratings			Unit
			min.	typ.	max.	
R_{25}	resistance	$T_C = 25^\circ\text{C}$	4.75	5.0	5.25	k Ω
$B_{25/50}$				3375		K

Module

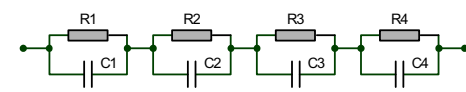
Symbol	Definitions	Conditions	Ratings			Unit
			min.	typ.	max.	
T_{VJ}	operating temperature		-40		125	$^\circ\text{C}$
T_{VJM}	max. virtual junction temperature				150	$^\circ\text{C}$
T_{stg}	storage temperature		-40		125	$^\circ\text{C}$
V_{ISOL}	isolation voltage	$I_{ISOL} \leq 1 \text{ mA}; 50/60 \text{ Hz}$			2500	V~
CTI	comparative tracking index				200	
M_d	mounting torque (M5)		2.7		3.3	Nm
d_s	creep distance on surface		10			mm
d_A	strike distance through air		7.5			mm
$R_{pin-chip}$	resistance pin to chip			2.5		m Ω
R_{thCH}	thermal resistance case to heatsink	with heatsink compound		0.02		K/W
Weight				300		g

0.0 Equivalent Circuits for Simulation



Ratings

Symbol	Definitions	Conditions	min.	typ.	max.	Unit
V_0 R_0	IGBT	T1 - T6 $T_{VJ} = 125^\circ\text{C}$		1.0 91		V m Ω
V_0 R_0	Diode	D1 - D6 $T_{VJ} = 150^\circ\text{C}$		1.09 9.1		V m Ω



$$Z_{th}(t) = \sum_{i=1}^n \left[R_i \cdot \left(1 - \exp\left(-\frac{t}{\tau_i}\right) \right) \right]$$

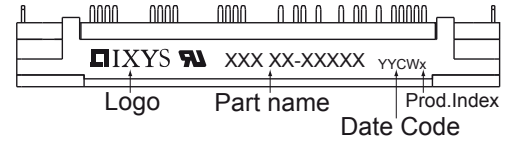
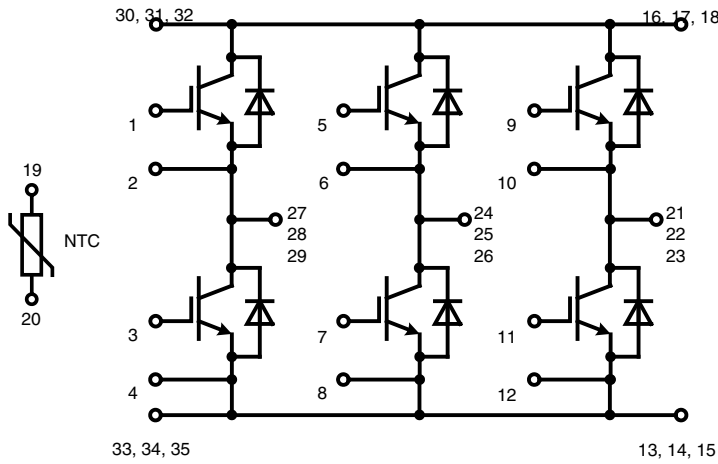
$$\tau_i = R_i \cdot C_i$$

	IGBT	Diode
R_1	0.03985	0.084
R_2	0.05038	0.069
R_3	0.08959	0.146
R_4	0.08018	0.101
τ_1	0.0025	0.0025
τ_2	0.076	0.076
τ_3	0.036	0.036
τ_4	0.076	0.076

$T_C = 25^\circ\text{C}$ unless otherwise stated

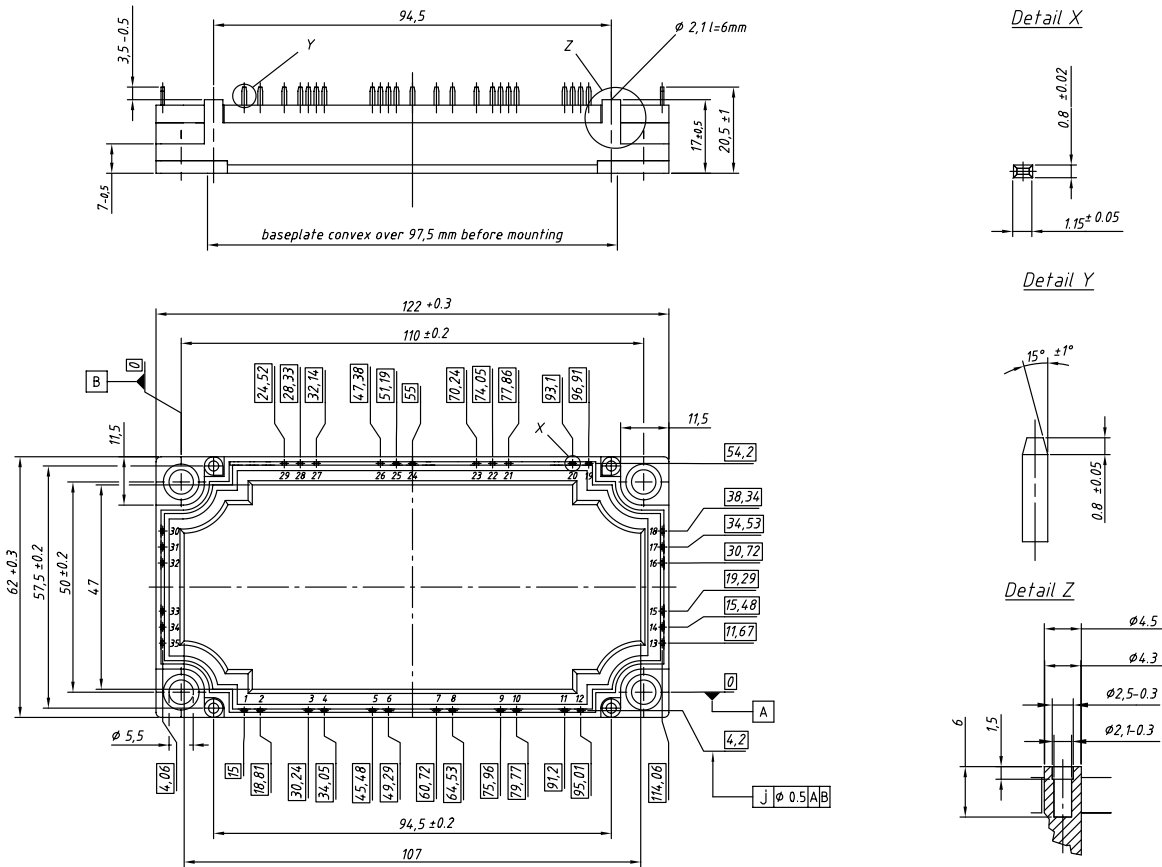
Circuit Diagram

Marking on Product



Outline Drawing

Dimensions in mm (1 mm = 0.0394")



Product Marking

Ordering	Part Name	Marking on Product	Delivering Mode	Base Qty	Ordering Code
Standard	MWI100-12T8T	MWI100-12T8T	Box	5	502294

IXYS reserves the right to change limits, test conditions and dimensions.

20100910c

© 2010 IXYS All rights reserved

4 - 7

Inverter T1 - T6

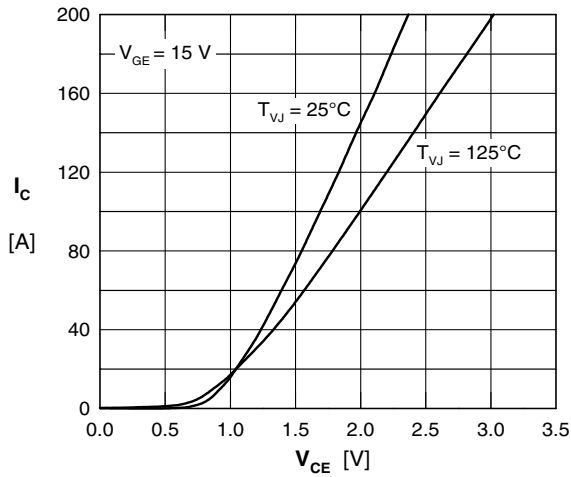


Fig. 1 Typ. output characteristics

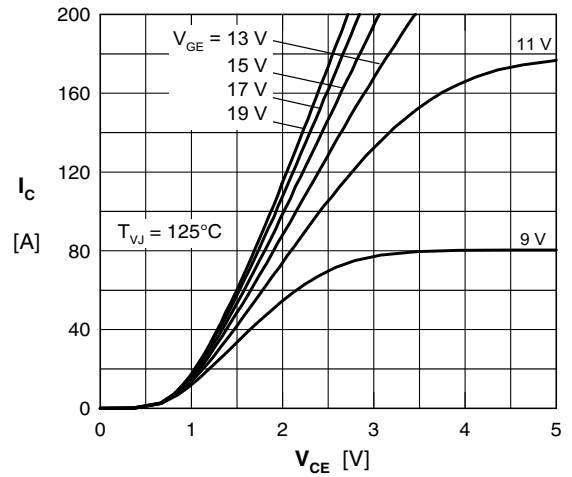


Fig. 2 output characteristics

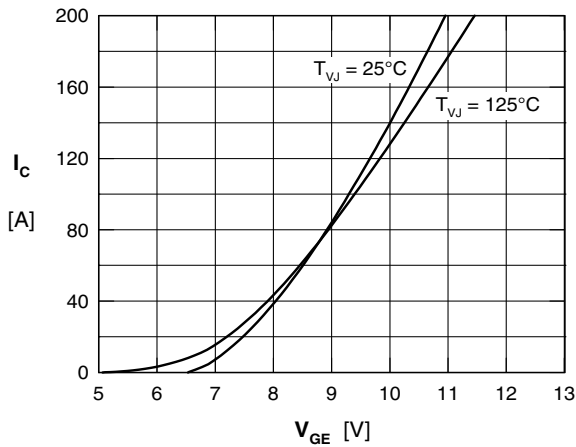


Fig. 3 Typ. transfer characteristics

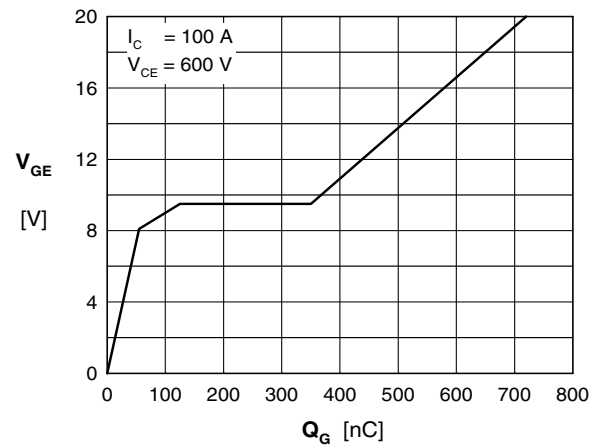


Fig. 4 Typ. turn-on gate charge

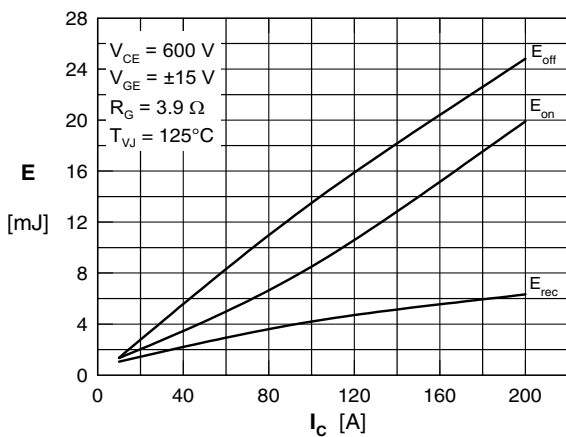


Fig. 5 Typ. switching energy vs. collector current

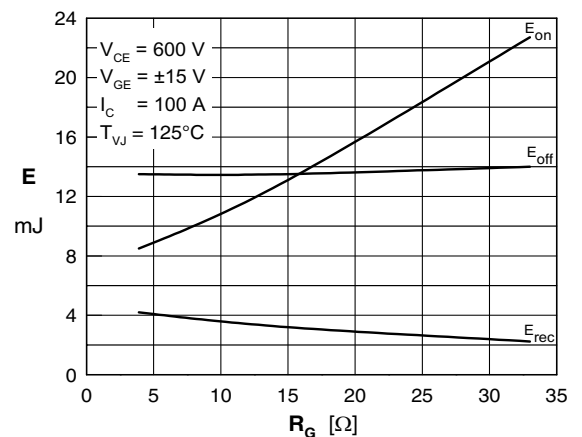


Fig. 6 Typ. switching energy vs. gate resistance

Inverter D1 - D6

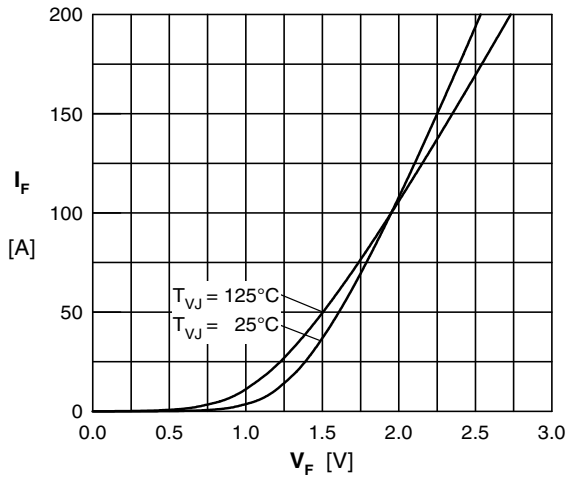


Fig. 7 Typ. Forward current versus V_F

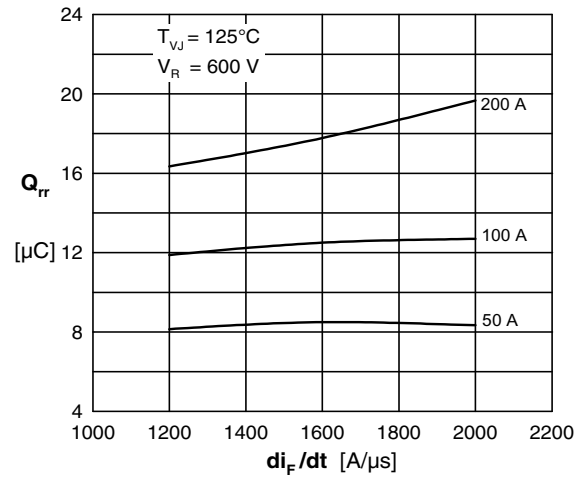


Fig. 8 Typ. reverse recov.charge Q_{rr} vs. di/dt

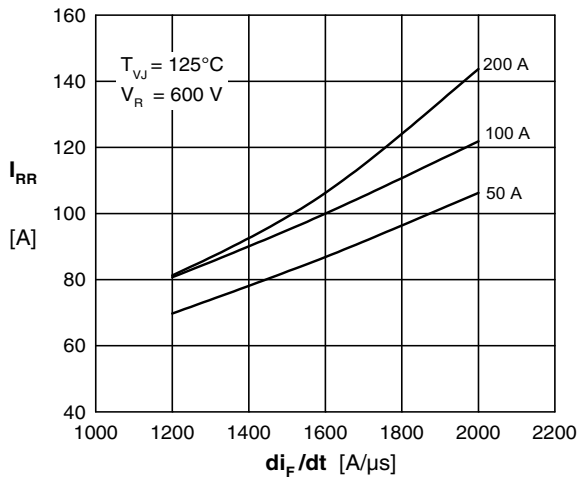


Fig. 9 Typ. peak reverse current I_{RM} vs. di/dt

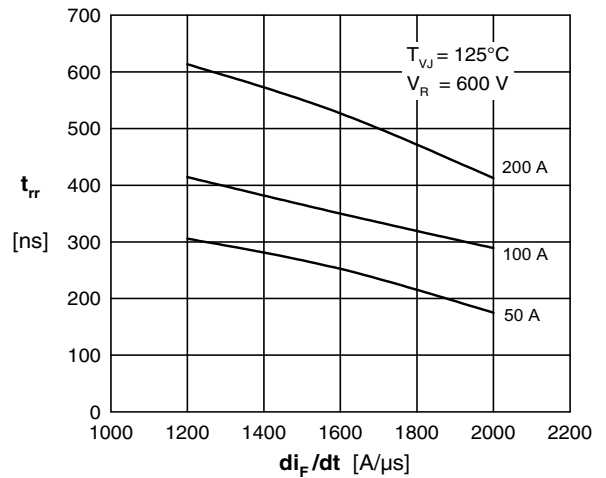


Fig. 10 Typ. recovery time t_{rr} versus di/dt

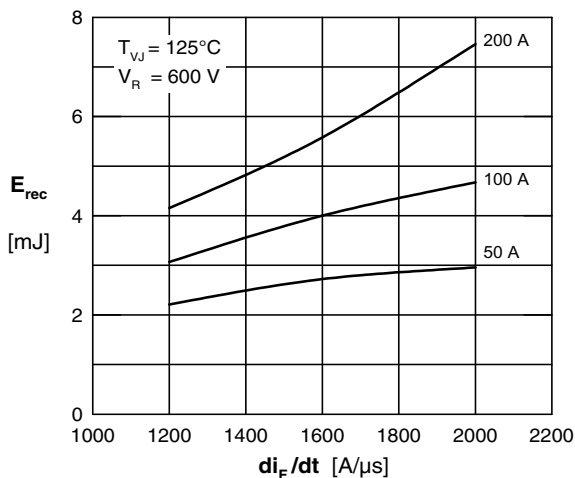


Fig. 11 Typ. recovery energy E_{rec} versus di/dt

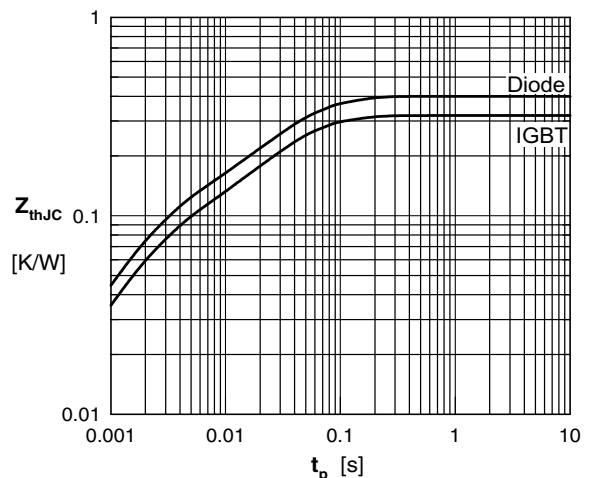


Fig. 12 Typ. transient thermal impedance

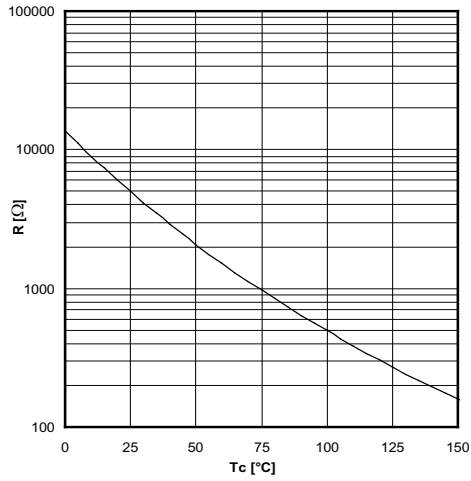
NTC

Fig. 13 Typ. NTC resistance vs. temperature

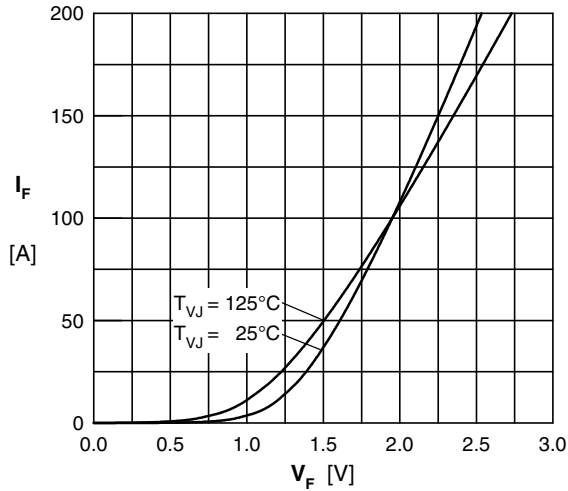


Fig. 7 Typ. Forward current versus V_F

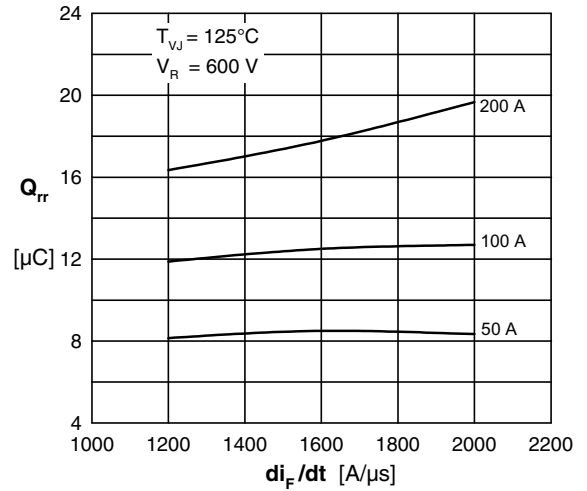


Fig. 8 Typ. reverse recov.charge Q_{rr} vs. di/dt

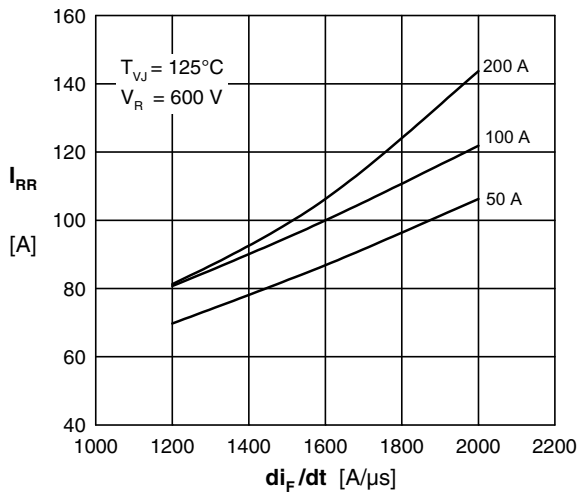


Fig. 9 Typ. peak reverse current I_{RM} vs. di/dt

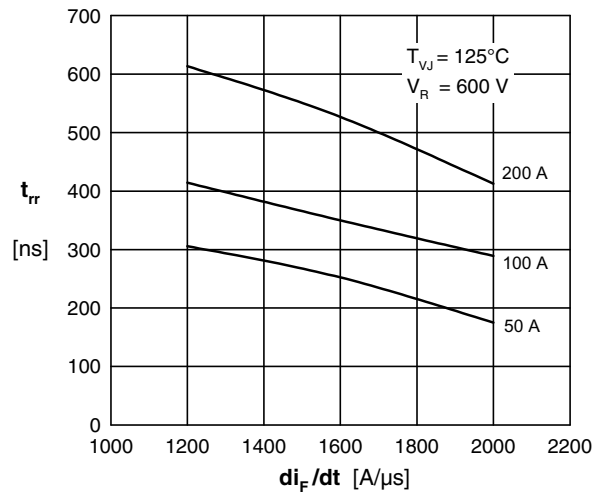


Fig. 10 Typ. recovery time t_{rr} versus di/dt

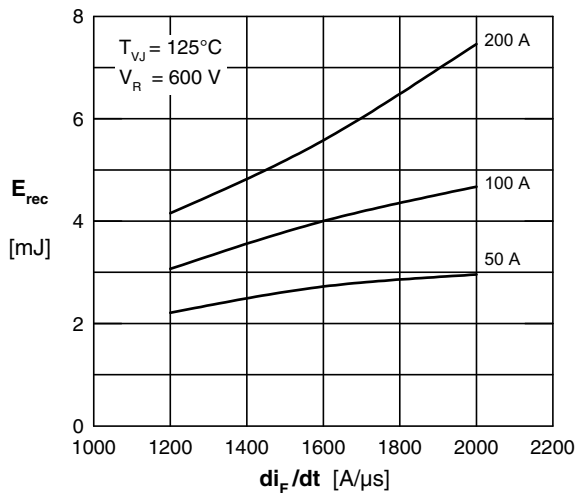


Fig. 11 Typ. recovery energy E_{rec} versus di/dt

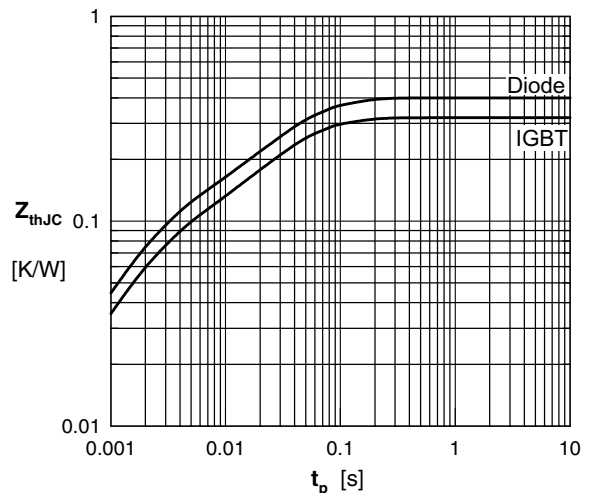


Fig. 12 Typ. transient thermal impedance