

### Dual IGBTMOD™ H-Series Module 200 Amperes/600 Volts

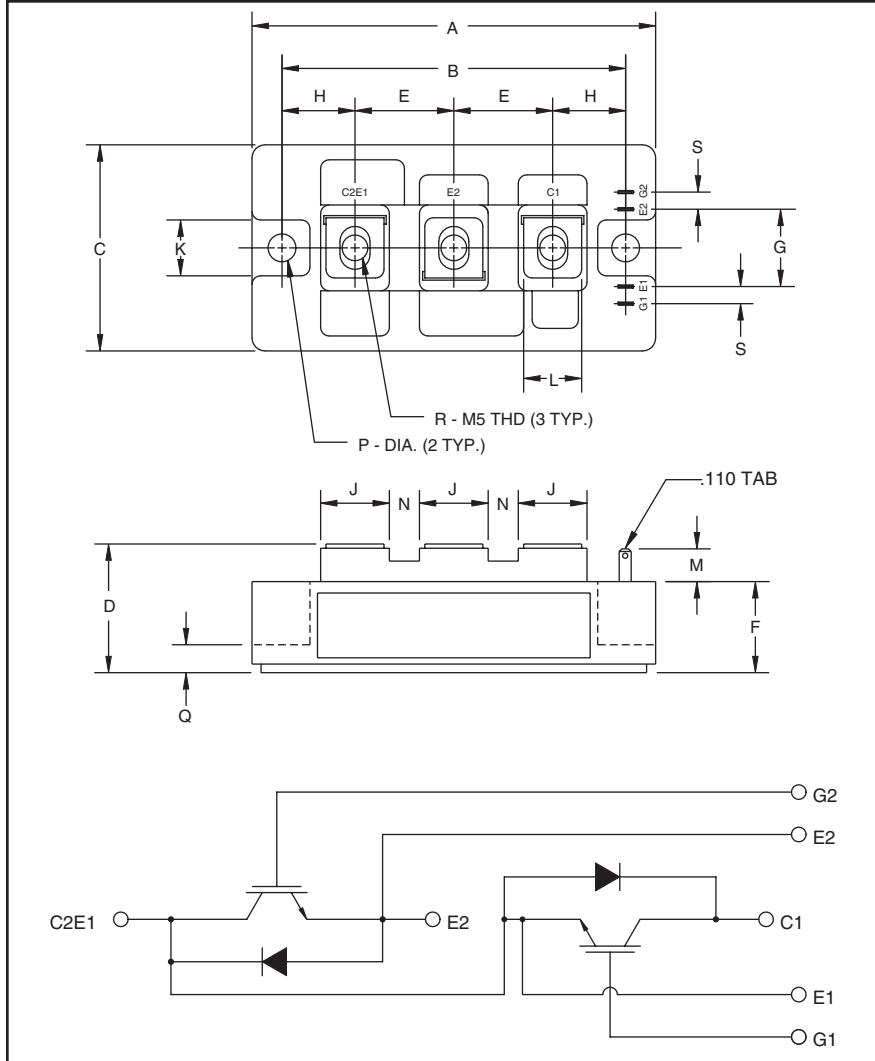

Outline Drawing and Circuit Diagram

Dimensions	Inches	Millimeters
A	3.70	94.0
B	3.150±0.01	80.0±0.25
C	1.89	48.0
D	1.18 Max.	30.0 Max.
E	0.90	23.0
F	0.83	21.2
G	0.71	18.0
H	0.67	17.0
J	0.63	16.0

Dimensions	Inches	Millimeters
K	0.51	13.0
L	0.47	12.0
M	0.30	7.5
N	0.28	7.0
P	0.256 Dia.	Dia. 6.5
Q	0.31	8.0
R	M5 Metric	M5
S	0.16	4.0



#### Description:

Powerex IGBTMOD™ Modules are designed for use in switching applications. Each module consists of two IGBT Transistors in a half-bridge configuration with each transistor having a reverse-connected super-fast recovery free-wheel diode. All components and interconnects are isolated from the heat sinking baseplate, offering simplified system assembly and thermal management.

#### Features:

- Low Drive Power
- Low  $V_{CE(sat)}$
- Discrete Super-Fast Recovery (70ns) Free-Wheel Diode
- High Frequency Operation (20-25kHz)
- Isolated Baseplate for Easy Heat Sinking

#### Applications:

- AC Motor Control
- Motion/Servo Control
- UPS
- Welding Power Supplies
- Laser Power Supplies

#### Ordering Information:

Example: Select the complete part module number you desire from the table below -i.e. CM200DY-12H is a 600V ( $V_{CES}$ ), 200 Ampere Dual IGBTMOD™ Power Module.

Type	Current Rating Amperes	$V_{CES}$ Volts (x 50)
CM	200	12

**CM200DY-12H**  
**Dual IGBTMOD™ H-Series Module**  
 200 Amperes/600 Volts

**Absolute Maximum Ratings,  $T_j = 25\text{ °C}$  unless otherwise specified**

Ratings	Symbol	CM200DY-12H	Units
Junction Temperature	$T_j$	-40 to 150	°C
Storage Temperature	$T_{stg}$	-40 to 125	°C
Collector-Emitter Voltage (G-E Short)	$V_{CES}$	600	Volts
Gate-Emitter Voltage	$V_{GES}$	±20	Volts
Collector Current	$I_C$	200	Amperes
Peak Collector Current	$I_{CM}$	400*	Amperes
Diode Forward Current	$I_F$	200	Amperes
Diode Forward Surge Current	$I_{FM}$	400*	Amperes
Power Dissipation	$P_d$	780	Watts
Mounting Torque, M5 Terminal Screws	—	17	in-lb
Mounting Torque, M6 Mounting Screws	—	26	in-lb
Module Weight (Typical)	—	270	Grams
V Isolation	$V_{RMS}$	2500	Volts

\* Pulse width and repetition rate should be such that device junction temperature does not exceed the device rating.

**Static Electrical Characteristics,  $T_j = 25\text{ °C}$  unless otherwise specified**

Characteristics	Symbol	Test Conditions	Min.	Typ.	Max.	Units
Collector-Cutoff Current	$I_{CES}$	$V_{CE} = V_{CES}, V_{GE} = 0V$	—	—	1.0	mA
Gate Leakage Current	$I_{GES}$	$V_{GE} = V_{GES}, V_{CE} = 0V$	—	—	0.5	μA
Gate-Emitter Threshold Voltage	$V_{GE(th)}$	$I_C = 20mA, V_{CE} = 10V$	4.5	6.0	7.5	Volts
Collector-Emitter Saturation Voltage	$V_{CE(sat)}$	$I_C = 200A, V_{GE} = 15V$	—	2.1	2.8**	Volts
		$I_C = 200A, V_{GE} = 15V, T_j = 150\text{ °C}$	—	2.15	—	Volts
Total Gate Charge	$Q_G$	$V_{CC} = 300V, I_C = 200A, V_{GE} = 15V$	—	600	—	nC
Diode Forward Voltage	$V_{FM}$	$I_E = 200A, V_{GE} = 0V$	—	—	2.8	Volts

\*\* Pulse width and repetition rate should be such that device junction temperature rise is negligible.

**Dynamic Electrical Characteristics,  $T_j = 25\text{ °C}$  unless otherwise specified**

Characteristics	Symbol	Test Conditions	Min.	Typ.	Max.	Units
Input Capacitance	$C_{ies}$		—	—	20	nF
Output Capacitance	$C_{oes}$	$V_{GE} = 0V, V_{CE} = 10V$	—	—	7	nF
Reverse Transfer Capacitance	$C_{res}$		—	—	4	nF
Inductive	Turn-on Delay Time	$V_{CC} = 300V, I_C = 200A,$ $V_{GE1} = V_{GE2} = 15V, R_G = 3.1\Omega$	—	—	200	ns
	Rise Time					
Load	Turn-off Delay Time		—	—	300	ns
	Fall Time					
Diode Reverse Recovery Time	$t_{rr}$	$I_E = 200A, di_E/dt = -400/\mu s$	—	—	110	ns
Diode Reverse Recovery Charge	$Q_{rr}$	$I_E = 200A, di_E/dt = -400/\mu s$	—	0.54	—	μC

**Thermal and Mechanical Characteristics,  $T_j = 25\text{ °C}$  unless otherwise specified**

Characteristics	Symbol	Test Conditions	Min.	Typ.	Max.	Units
Thermal Resistance, Junction to Case	$R_{th(j-c)}$	Per IGBT	—	—	0.16	°C/W
Thermal Resistance, Junction to Case	$R_{th(j-c)}$	Per FWDi	—	—	0.35	°C/W
Contact Thermal Resistance	$R_{th(c-f)}$	Per Module, Thermal Grease Applied	—	—	0.065	°C/W

**CM200DY-12H**  
**Dual IGBTMOD™ H-Series Module**  
 200 Amperes/600 Volts

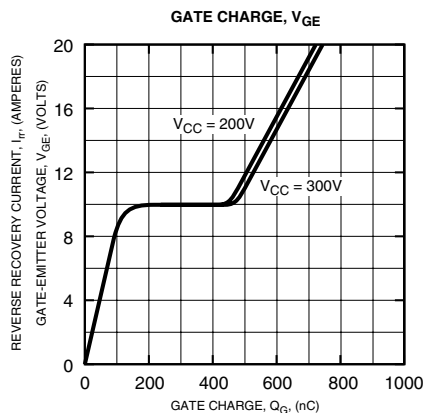
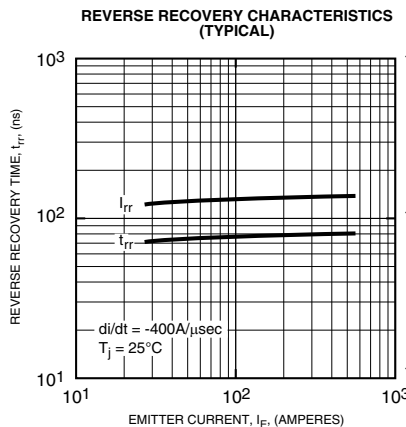
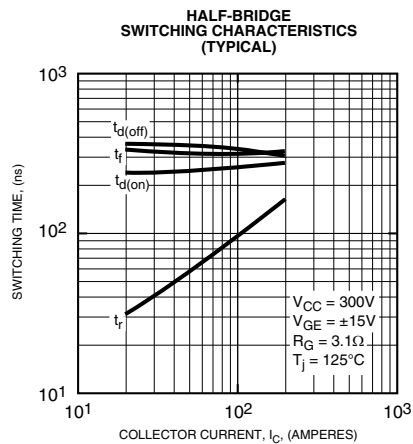
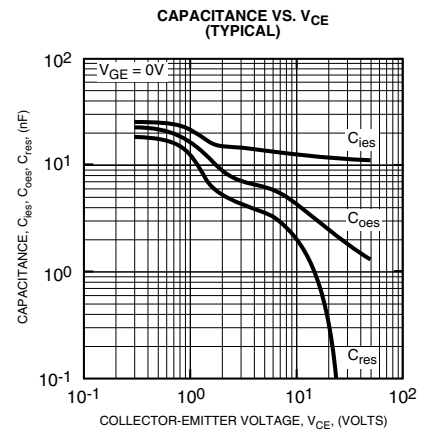
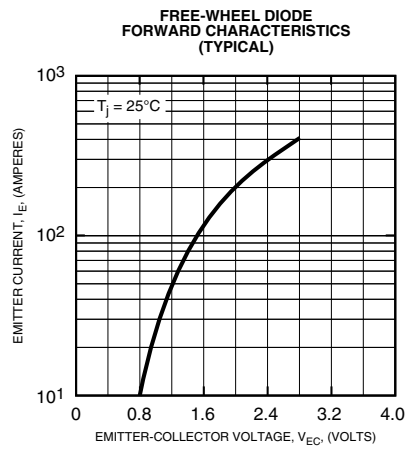
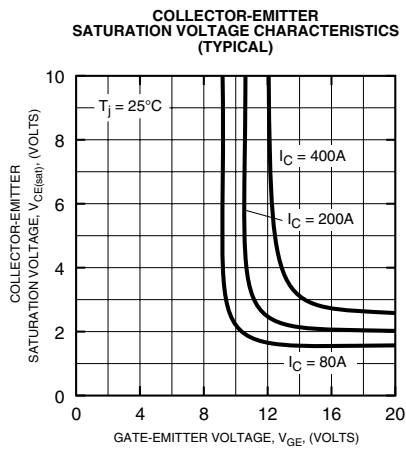
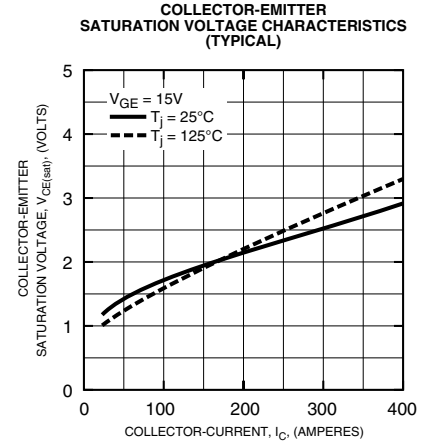
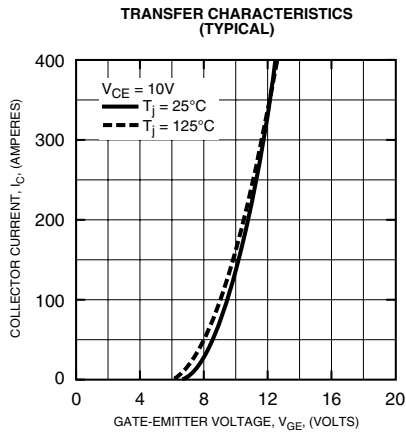
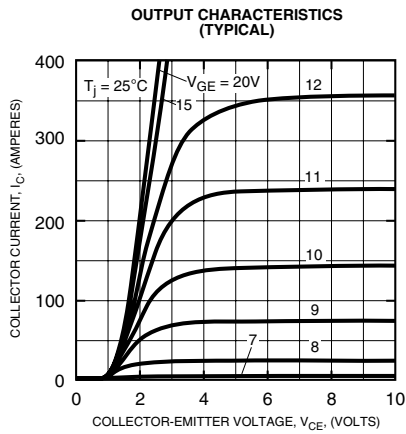

**CM200DY-12H**  
**Dual IGBTMOD™ H-Series Module**  
 200 Amperes/600 Volts

