

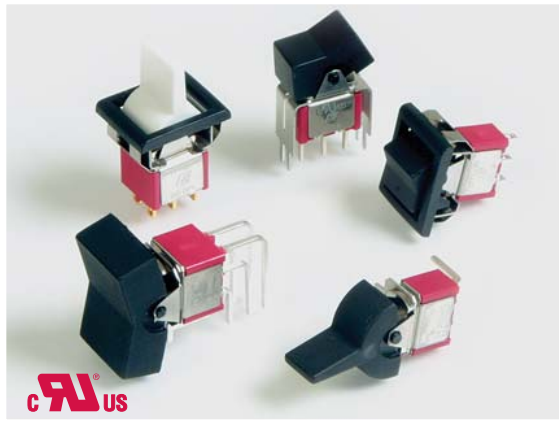

# SERIES 300 SWITCHES

## ROCKER AND PADDLE SWITCHES - MINIATURE



### FEATURES & BENEFITS

- ▶ Multiple rocker & paddle options
- ▶ Up to 4 poles
- ▶ Multiple termination options
- ▶ Snap-in panel mount option available

### APPLICATIONS/MARKETS

- ▶ Telecommunications
- ▶ Instrumentation
- ▶ Test equipment
- ▶ Networking
- ▶ Computer peripherals

### SPECIFICATIONS

Contact Rating:	Dependent upon contact material
Life Expectancy:	50,000 make-and-break cycles at full load
Contact Resistance:	10 mΩ max. initial @ 2-4 VDC 100 mA for both silver and gold plated contacts
Insulation Resistance:	1,000 MΩ min.
Dielectric Strength:	1,000 V RMS @ sea level
Operating Temperature:	-30° C to 85° C

### MATERIALS

Case:	Diallyl Phthalate (DAP)
Rockers:	Nylon
Bushing:	Brass, nickel plated
Housing:	Stainless steel
Terminal/Switch Support:	Brass, steel, electrotin plated
Contacts/Terminals:	Silver or gold plated copper alloy



### HOW TO ORDER

SERIES 300	MODEL NO.	ACTUATOR	ACTUATOR** COLOR	TERMINATION	CONTACT MATERIAL	SEAL	FRAME** COLOR
	SP1 SP2 SP3 SP4 SP5 DP1 DP2 DP3 DP4 DP5 DP6 DP7 DP8 3P1 3P2 3P3 3P4 3P5 4P1 4P2 4P3 4P4 4P5 4P6	Panel Mount: R1 R2 R3 R4 R6* R7* R8* R9* R11 R16  *Snap in panel mount	NONE = Black WHT=White RED = Red YEL = Yellow GRY = Gray PUR = Purple  **Contact E-Switch for additional colors	M1 M3 M5	Q = Silver R = Gold	E = Epoxy Sealed at Base of Terminal	(R6, R7 Only) BLK= Black WHT=White RED= Red YEL = Yellow GRY= Gray PUR= Purple  **Contact E-Switch for additional colors
	(See Above Model No. Options)	P.C. Mount: J1 J2 J3 J4 J5 J6	BLK =Black WHT=White RED =Red YEL =Yellow GRY =Gray PUR =Purple	M2 M6 M7 VS2 VS3 VS4 VS5 M61 VS21	Q = Silver R = Gold	E = Epoxy Sealed at Base of Terminal	



### Example Ordering Number

300-SP1-R6-RED-M1-R-E-RED

Specifications subject to change without notice.

TACT SWITCHES

NAVIGATION SWITCHES

PUSHBUTTON SWITCHES

TOGGLE SWITCHES

ROCKER SWITCHES

SLIDE SWITCHES

SNAP-ACTION SWITCHES

DIP SWITCHES

KEYLOCK SWITCHES

ROTARY SWITCHES

DETECTOR SWITCHES

CAP OPTIONS

# SERIES 300 SWITCHES

## ROCKER AND PADDLE SWITCHES - MINIATURE

TACT SWITCHES

NAVIGATION SWITCHES

PUSHBUTTON SWITCHES

TOGGLE SWITCHES

ROCKER SWITCHES

SLIDE SWITCHES

SNAP-ACTION SWITCHES

DIP SWITCHES

KEYLOCK SWITCHES

ROTARY SWITCHES

DETECTOR SWITCHES

CAP OPTIONS

### SPDT



SCHEMATIC

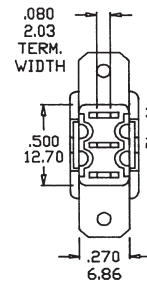
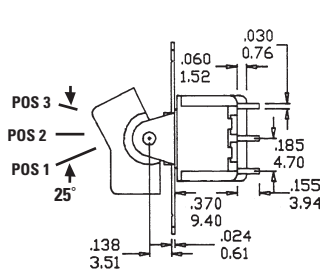
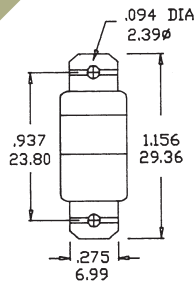

Model No.	POS 1	POS 2	POS 3
SP-1	ON	NONE	ON
SP-2	ON	NONE	(ON)
SP-3	ON	OFF	ON
SP-4	(ON)	OFF	(ON)
SP-5	ON	OFF	(ON)
Term. Comm.	2-3	OPEN	2-1

( ) = Momentary

### DPDT

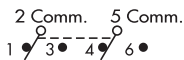

SCHEMATIC

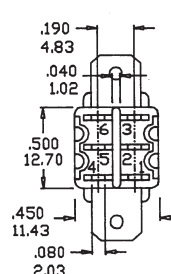
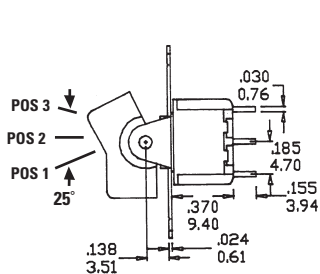
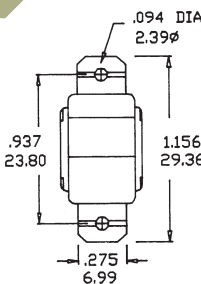

Model No.	POS 1	POS 2	POS 3
DP-1	ON	NONE	ON
DP-2	ON	NONE	(ON)
DP-3	ON	OFF	ON
DP-4	(ON)	OFF	(ON)
DP-5	ON	OFF	(ON)
DP-7	ON	ON	(ON)
DP-8	(ON)	ON	(ON)
Term. Comm.	2-3, 5-6	OPEN	2-1, 5-4

( ) = Momentary

### 3PDT



SCHEMATIC

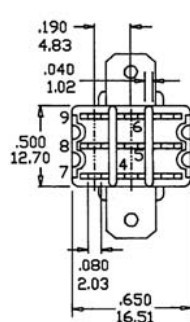
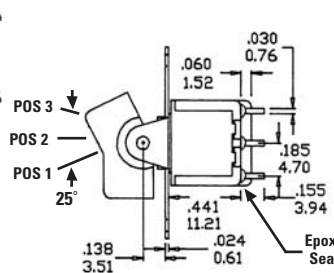
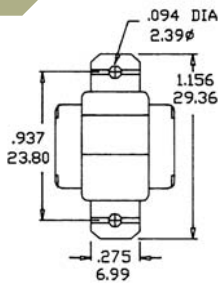

Model No.	POS 1	POS 2	POS 3
3P-1	ON	NONE	ON
3P-2	ON	NONE	(ON)
3P-3	ON	OFF	ON
3P-4	(ON)	OFF	(ON)
3P-5	ON	OFF	(ON)
Term. Comm.	2-3, 5-6, 8-9	OPEN	2-1, 5-4, 8-7

( ) = Momentary

### 4PDT

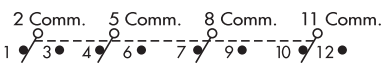

SCHEMATIC

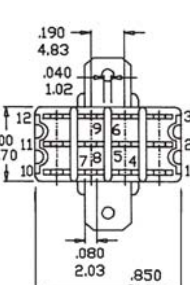
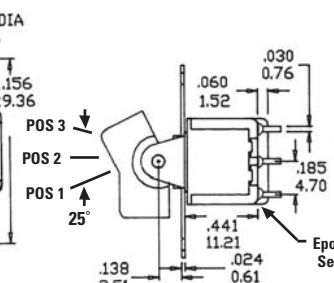
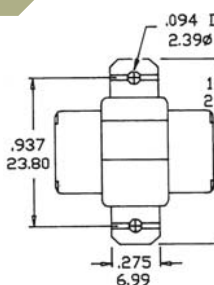

Model No.	POS 1	POS 2	POS 3
4P-1	ON	NONE	ON
4P-2	ON	NONE	(ON)
4P-3	ON	OFF	ON
4P-4	(ON)	OFF	(ON)
4P-5	ON	OFF	(ON)
Term. Comm.	2-3, 5-6, 8-9, 11-12	OPEN	2-1, 5-4, 8-7, 11-10
4P-6	ON	ON	ON
Term. Comm.	2-3, 5-6, 8-9, 11-12	2-3, 5-4, 8-9, 11-10	2-1, 5-4, 8-7, 11-10

( ) = Momentary



ACTUATOR OPTIONS – PANEL MOUNT

R1

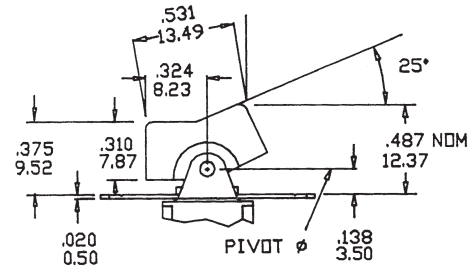
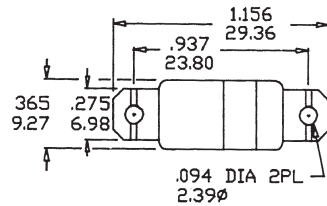

R2

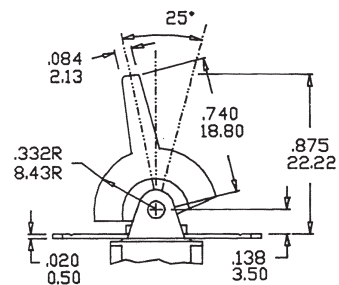
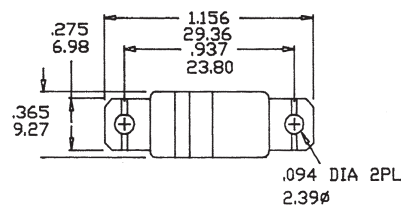

R3

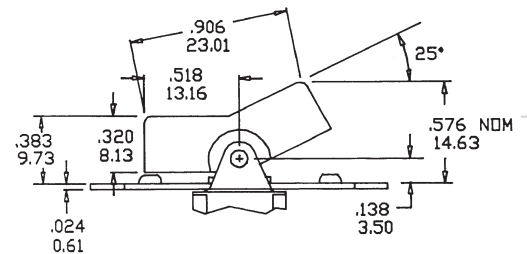
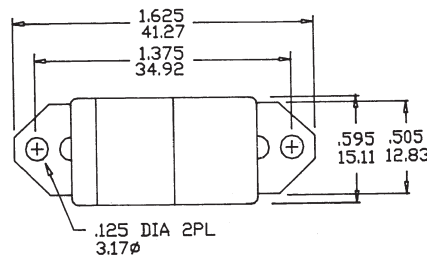

R4

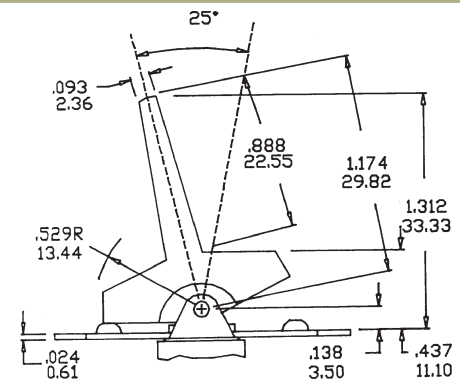
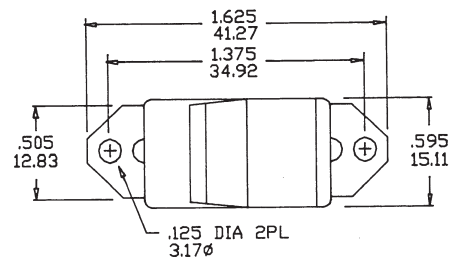

R11

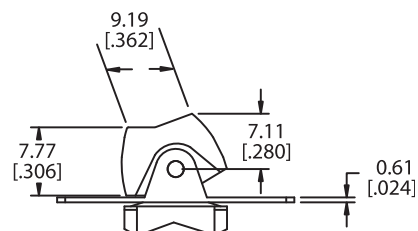
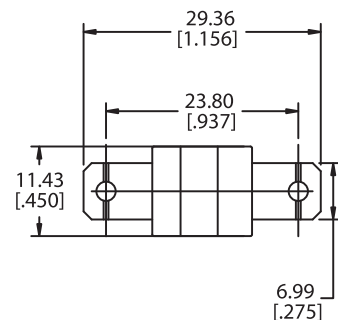

TACT SWITCHES

NAVIGATION SWITCHES

PUSHBUTTON SWITCHES

TOGGLE SWITCHES

ROCKER SWITCHES

SLIDE SWITCHES

SNAP-ACTION SWITCHES

DIP SWITCHES

KEYLOCK SWITCHES

ROTARY SWITCHES

DETECTOR SWITCHES

CAP OPTIONS

# SERIES 300 SWITCHES

## ROCKER AND PADDLE SWITCHES - MINIATURE

TACT SWITCHES

NAVIGATION SWITCHES

PUSHBUTTON SWITCHES

### R16

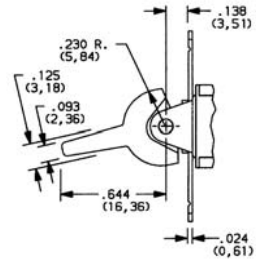
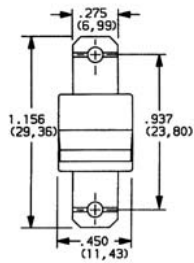

### ACTUATOR OPTIONS – SNAP-IN FRONT MOUNT

TOGGLE SWITCHES

ROCKER SWITCHES

### R6

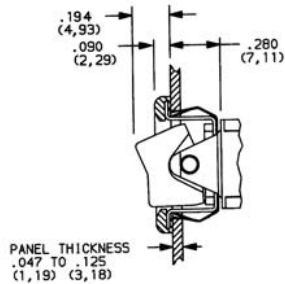
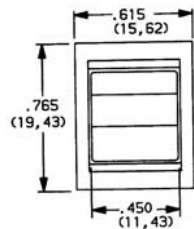

SLIDE SWITCHES

SNAP-ACTION SWITCHES

### R7

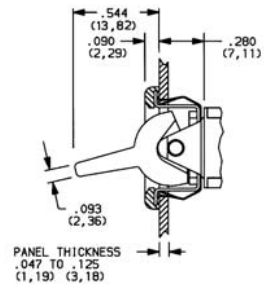
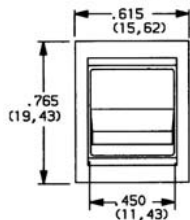

DIP SWITCHES

KEYLOCK SWITCHES

### R8

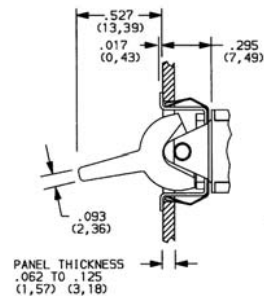
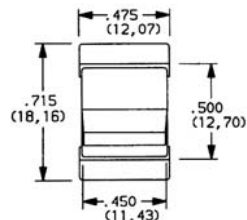

ROTARY SWITCHES

DETECTOR SWITCHES

### R9

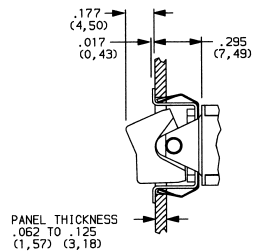
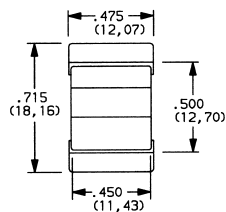

CAP OPTIONS

### Actuator & Frame Colors:

Black, White, Red

Consult E-Switch for other colors and custom actuator marking.



### RECOMMENDED PANEL MOUNTING

FOR R1-R2

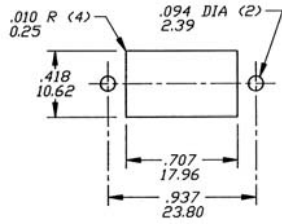

FOR R2-R3

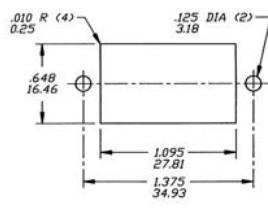

FOR R6-R9

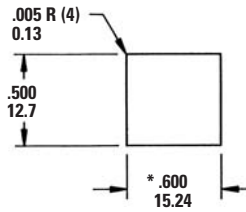

FOR R11-R16

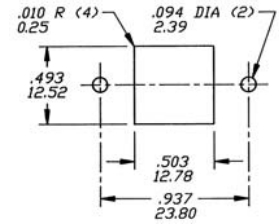

\* For R8 and R9: Increase this dim. to .620/.625 (15.75/15.88) for .091/.125 (2.31/3.18) thk. panels.

\* For R6 and R7: Increase this dim. to .620/.625 (15.75/15.88) for .060/.125 (1.52/3.18) thk. panels.

### ACTUATOR OPTIONS – P.C. MOUNT

J1

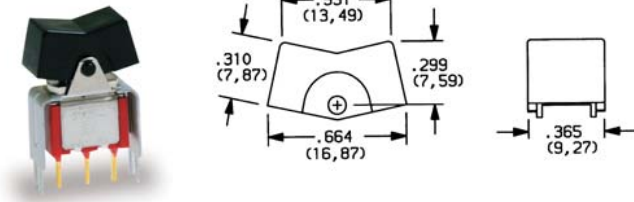

J2

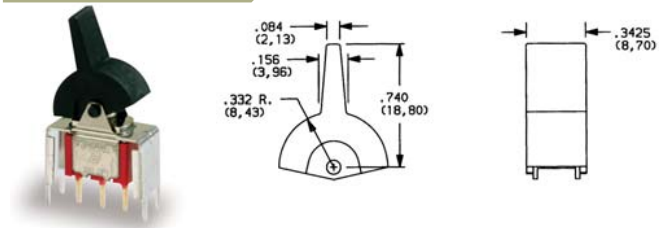

J3

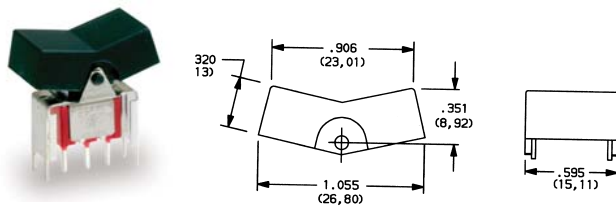

J4

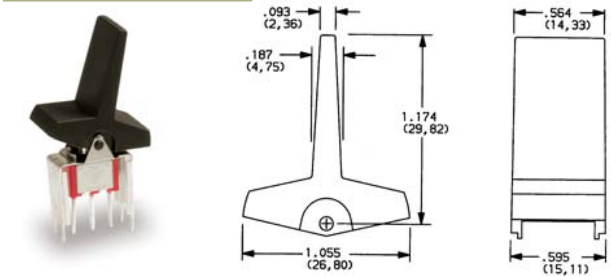

J5

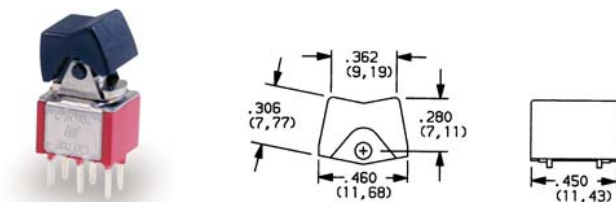

J6

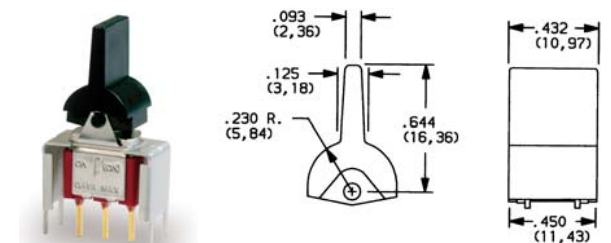

**Actuator & Frame Colors:**

Black, White, Red

Consult E-Switch for other colors and custom actuator marking.

TACT SWITCHES

NAVIGATION SWITCHES

PUSHBUTTON SWITCHES

TOGGLE SWITCHES

ROCKER SWITCHES

SLIDE SWITCHES

SNAP-ACTION SWITCHES

DIP SWITCHES

KEYLOCK SWITCHES

ROTARY SWITCHES

DETECTOR SWITCHES

CAP OPTIONS

# SERIES 300 SWITCHES

## ROCKER AND PADDLE SWITCHES - MINIATURE

### TERMINATION OPTIONS – PANEL MOUNT

**M1 STD**

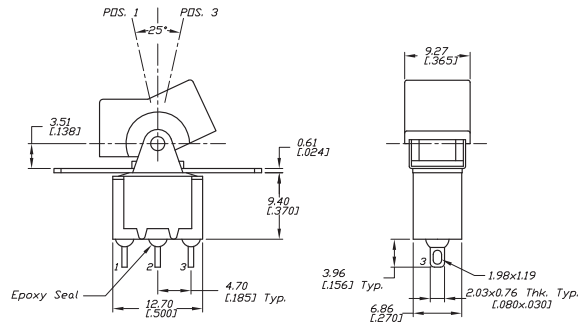

**M3 QUICK CONNECT**

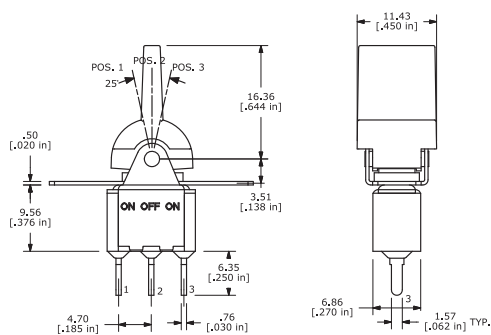

**M5**

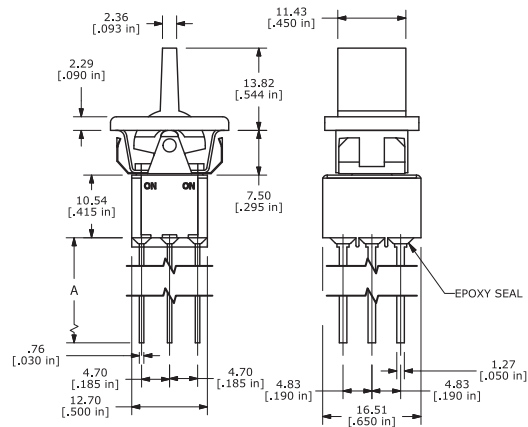

Option Code	Dim. 'A'
M51	.750 (19.05)
M52	.964 (24.48)
M53	.425 (10.80)
M54	1.062 (26.97)

### TERMINATION OPTIONS – P.C. MOUNT

**M2**

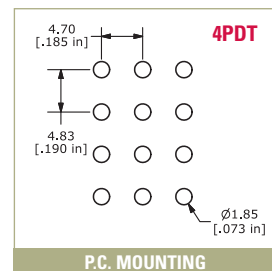
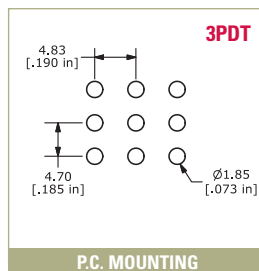
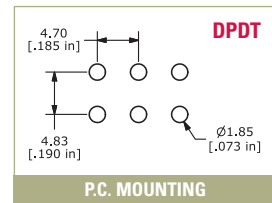
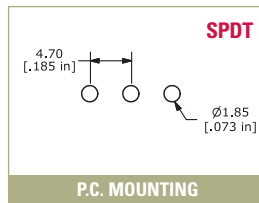
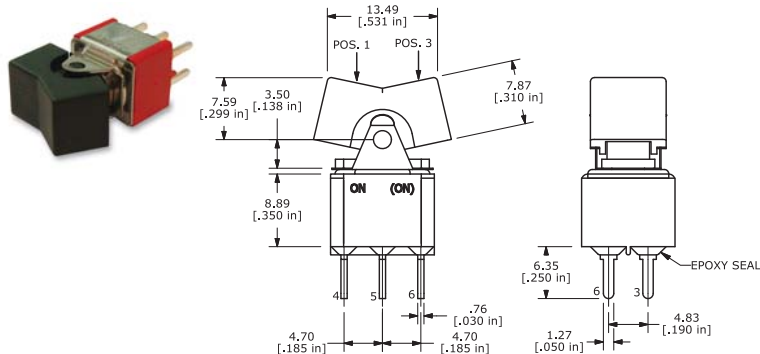





### M6

SPST  
Shown with J1  
Actuator

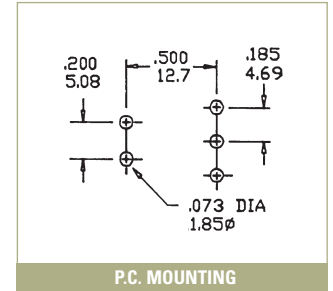
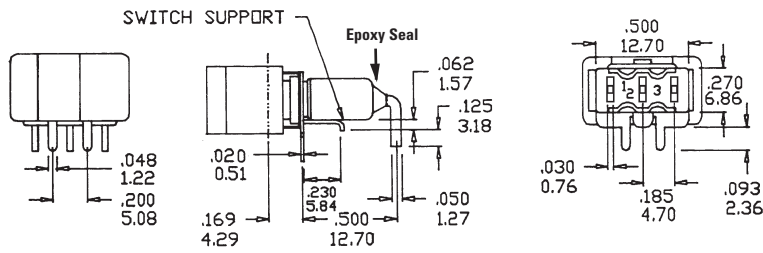

### M6

DPDT

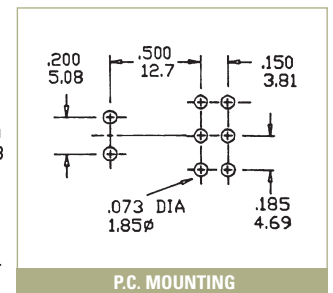
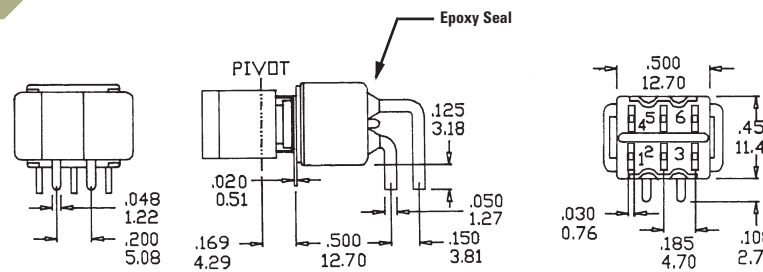

### M61

WITH P.C. BOARD  
RETENTION BRACKET

SPST

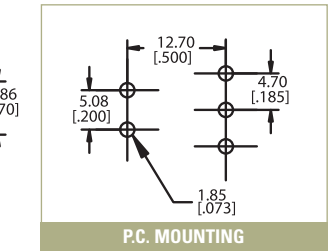
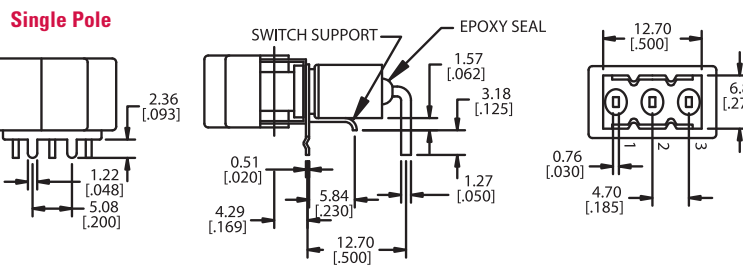

### M61

WITH P.C. BOARD  
RETENTION BRACKET

DPDT

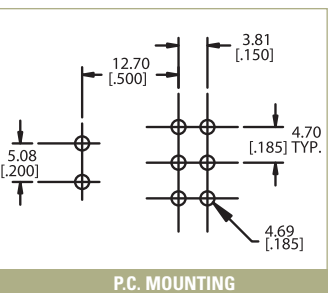
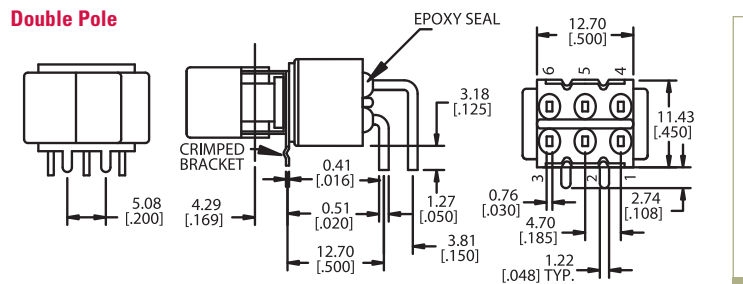

TACT SWITCHES

NAVIGATION SWITCHES

PUSHBUTTON SWITCHES

TOGGLE SWITCHES

ROCKER SWITCHES

SLIDE SWITCHES

SNAP-ACTION SWITCHES

DIP SWITCHES

KEYLOCK SWITCHES

ROTARY SWITCHES

DETECTOR SWITCHES

CAP OPTIONS

# SERIES 300 SWITCHES

## ROCKER AND PADDLE SWITCHES - MINIATURE

TACT SWITCHES

NAVIGATION SWITCHES

PUSHBUTTON SWITCHES

### M7

SPDT

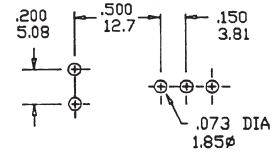
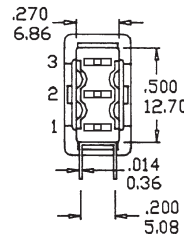
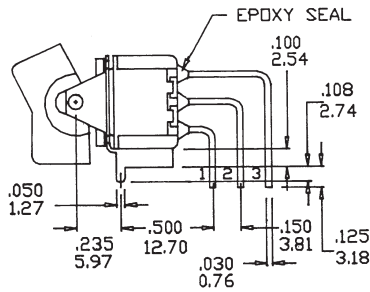
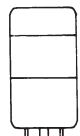

P.C. MOUNTING

TOGGLE SWITCHES

ROCKER SWITCHES

### M7

DPDT

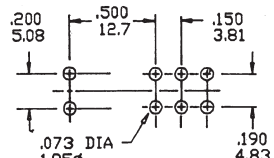
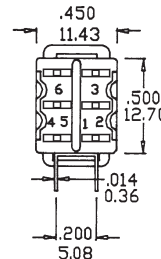
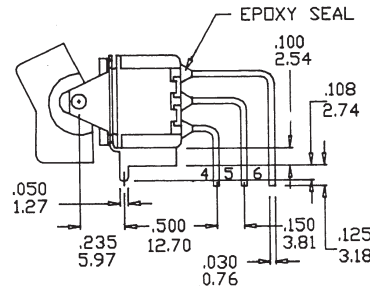
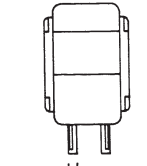

P.C. MOUNTING

SLIDE SWITCHES

SNAP-ACTION SWITCHES

### M7

3PDT

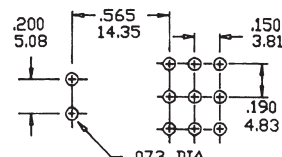
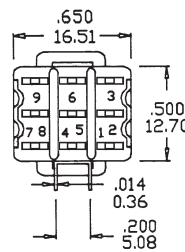
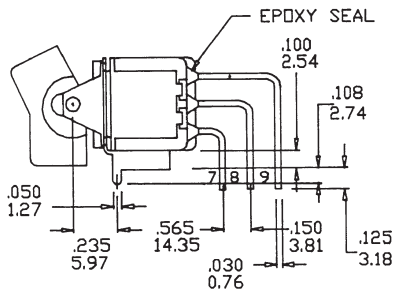
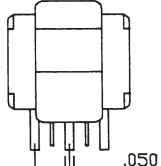

P.C. MOUNTING

DIP SWITCHES

KEYLOCK SWITCHES

ROTARY SWITCHES

### M7

4PDT

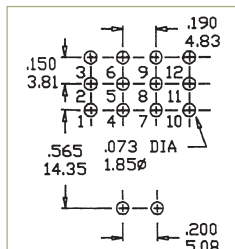
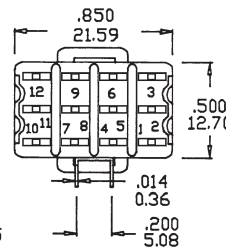
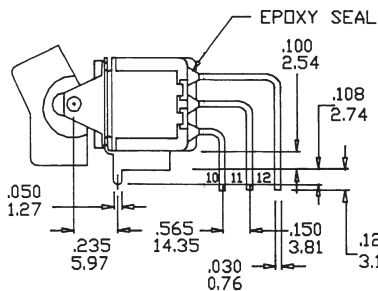
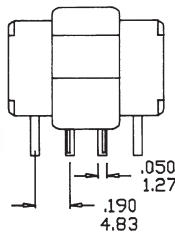

P.C. MOUNTING

DETECTOR SWITCHES

CAP OPTIONS

### VS2-VS3

SPDT

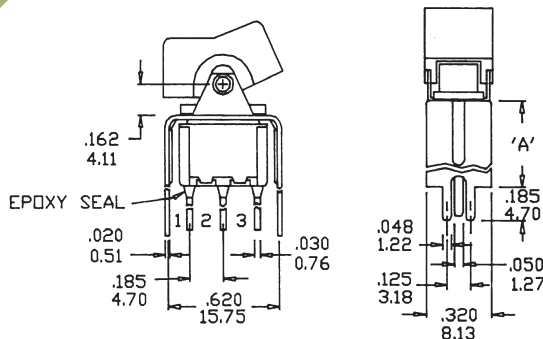

Option Code	Dim. 'A'
VS2	.460 (11.68)
VS3	.630 (16.00)

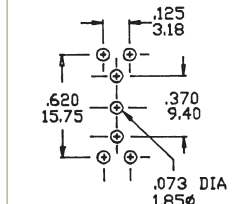

P.C. MOUNTING





### VS2-VS3

DPDT

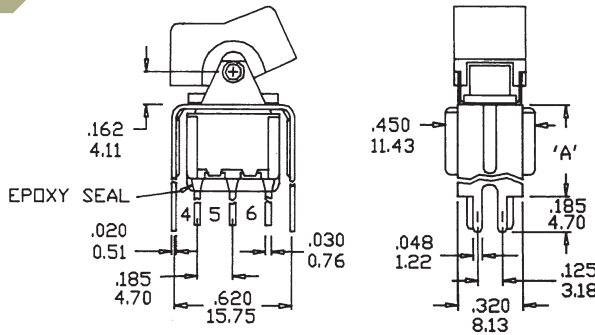

Option Code	Dim. 'A'
VS2	.460 (11.68)
VS3	.630 (16.00)

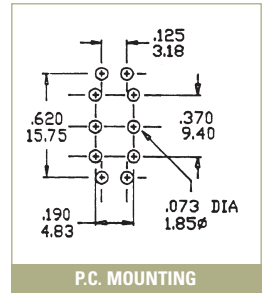

### VS4-VS5

SPDT

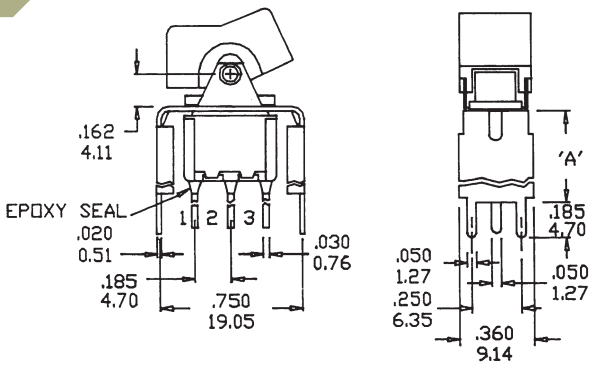

Option Code	Dim. 'A'
VS4	.460 (11.68)
VS5	.630 (16.00)

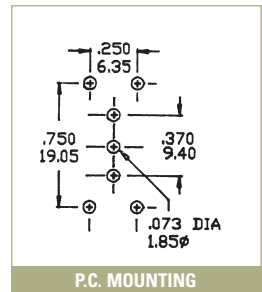

### VS5

DPDT

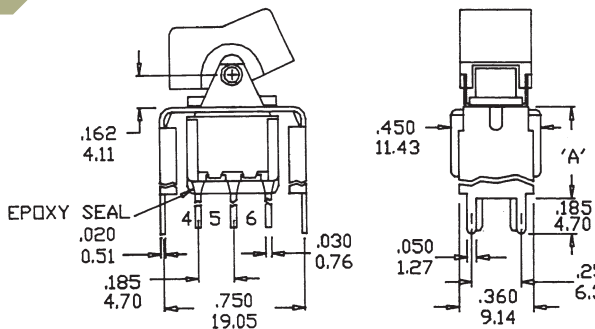

Option Code	Dim. 'A'
VS5	.630 (16.00)

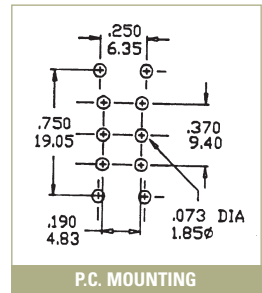

### CONTACT MATERIAL OPTIONS

**Q**

Fixed Terminal:	Silver plated copper alloy
Moving Contact:	Silver plated copper alloy
Rating:	5 Amps with resistive load @ 120VAC or 28VDC; 2 Amps with resistive load @ 250VAC

**R**

Fixed Terminal:	Copper alloy with gold plate over nickel plate
Moving Contact:	Copper alloy with gold plate over nickel plate
Rating:	0.4 Volt-Amps (VA) max. @ 20V max. (AC or DC)