

Converter - Brake - Inverter Module (CBI3)

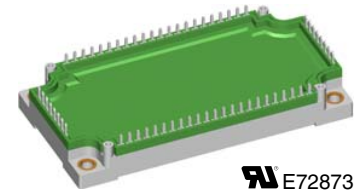
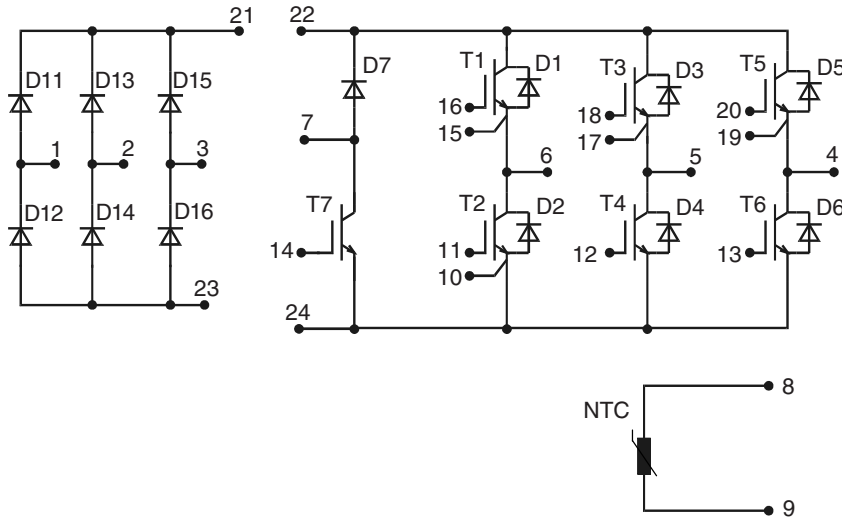

E72873

See outline drawing for pin arrangement

| Three Phase Rectifier | Brake Chopper | Three Phase Inverter |
|----------------------------|-------------------------------|-------------------------------|
| $V_{RRM} = 1600 \text{ V}$ | $V_{CES} = 1200 \text{ V}$ | $V_{CES} = 1200 \text{ V}$ |
| $I_{FAVM} = 42 \text{ A}$ | $I_{C25} = 35 \text{ A}$ | $I_{C25} = 50 \text{ A}$ |
| $I_{FSM} = 300 \text{ A}$ | $V_{CE(sat)} = 2.3 \text{ V}$ | $V_{CE(sat)} = 2.5 \text{ V}$ |

Input Rectifier D11 - D16

| Symbol | Conditions | Maximum Ratings | |
|------------|--|-----------------|---|
| V_{RRM} | | 1600 | V |
| I_{FAV} | $T_C = 80^\circ\text{C}$; sine 180° | 30 | A |
| I_{DAVM} | $T_C = 80^\circ\text{C}$; rectangular; $d = 1/3$; bridge | 80 | A |
| I_{FSM} | $T_{VJ} = 25^\circ\text{C}$; $t = 10 \text{ ms}$; sine 50 Hz | 300 | A |
| P_{tot} | $T_C = 25^\circ\text{C}$ | 100 | W |

| Symbol | Conditions | Characteristic Values ($T_{VJ} = 25^\circ\text{C}$, unless otherwise specified) | | |
|------------|--|--|------|---------------|
| | | min. | typ. | max. |
| V_F | $I_F = 35 \text{ A}$; $T_{VJ} = 25^\circ\text{C}$ $T_{VJ} = 125^\circ\text{C}$ | | 1.2 | 1.4 V V |
| I_R | $V_R = V_{RRM}$; $T_{VJ} = 25^\circ\text{C}$ $T_{VJ} = 125^\circ\text{C}$ | | 0.4 | 0.02 mA mA |
| R_{thJC} | (per diode) | | | 1.3 K/W |

Application: AC motor drives with

- Input from single or three phase grid
- Three phase synchronous or asynchronous motor
- electric braking operation

Features

- High level of integration - only one power semiconductor module required for the whole drive
- NPT IGBT technology with low saturation voltage, low switching losses, high RBSOA and short circuit ruggedness
- Epitaxial free wheeling diodes with Hiperfast and soft reverse recovery
- Industry standard package with insulated copper base plate and soldering pins for PCB mounting
- Temperature sense included

Output Inverter T1 - T6

| Symbol | Conditions | Maximum Ratings | |
|----------------------------|--|---|---------------|
| V_{CES} | $T_{VJ} = 25^{\circ}\text{C}$ to 150°C | 1200 | V |
| V_{GES} | Continuous | ± 20 | V |
| I_{C25} | $T_C = 25^{\circ}\text{C}$ | 50 | A |
| I_{C80} | $T_C = 80^{\circ}\text{C}$ | 35 | A |
| RBSOA | $V_{GE} = \pm 15\text{ V}$; $R_G = 47\ \Omega$; $T_{VJ} = 125^{\circ}\text{C}$ Clamped inductive load; $L = 100\ \mu\text{H}$ | $I_{CM} = 70$ $V_{CEK} \leq V_{CES}$ | A |
| t_{SC} (SCSOA) | $V_{CE} = V_{CES}$; $V_{GE} = \pm 15\text{ V}$; $R_G = 47\ \Omega$; $T_{VJ} = 125^{\circ}\text{C}$ non-repetitive | 10 | μs |
| P_{tot} | $T_C = 25^{\circ}\text{C}$ | 225 | W |

| Symbol | Conditions | Characteristic Values | | |
|---------------|--|--|------|----------|
| | | (T _{VJ} = 25°C, unless otherwise specified) | | |
| | | min. | typ. | max. |
| $V_{CE(sat)}$ | $I_C = 35\text{ A}$; $V_{GE} = 15\text{ V}$; $T_{VJ} = 25^{\circ}\text{C}$ $T_{VJ} = 125^{\circ}\text{C}$ | 2.5 | 3.1 | V |
| | | 2.9 | | V |
| $V_{GE(th)}$ | $I_C = 1\text{ mA}$; $V_{GE} = V_{CE}$ | 4.5 | 6.5 | V |
| I_{CES} | $V_{CE} = V_{CES}$; $V_{GE} = 0\text{ V}$; $T_{VJ} = 25^{\circ}\text{C}$ $T_{VJ} = 125^{\circ}\text{C}$ | 1.0 | 1.1 | mA mA |
| I_{GES} | $V_{CE} = 0\text{ V}$; $V_{GE} = \pm 20\text{ V}$ | | 200 | nA |
| $t_{d(on)}$ | Inductive load, $T_{VJ} = 125^{\circ}\text{C}$ $V_{CE} = 600\text{ V}$; $I_C = 35\text{ A}$ $V_{GE} = \pm 15\text{ V}$; $R_G = 47\ \Omega$ | 100 | | ns |
| t_r | | 70 | | ns |
| $t_{d(off)}$ | | 500 | | ns |
| t_f | | 70 | | ns |
| E_{on} | | 5.3 | | mJ |
| E_{off} | | 3.9 | | mJ |
| C_{ies} | $V_{CE} = 25\text{ V}$; $V_{GE} = 0\text{ V}$; $f = 1\text{ MHz}$ | 1.65 | | nF |
| Q_{Gon} | $V_{CE} = 600\text{ V}$; $V_{GE} = 15\text{ V}$; $I_C = 35\text{ A}$ | 120 | | nC |
| R_{thJC} | (per IGBT) | | 0.55 | K/W |

Output Inverter D1 - D6

| Symbol | Conditions | Maximum Ratings | |
|-----------|----------------------------|-----------------|---|
| I_{F25} | $T_C = 25^{\circ}\text{C}$ | 50 | A |
| I_{F80} | $T_C = 80^{\circ}\text{C}$ | 35 | A |

| Symbol | Conditions | Characteristic Values | | |
|------------|--|-----------------------|------|------|
| | | min. | typ. | max. |
| V_F | $I_F = 35\text{ A}$; $V_{GE} = 0\text{ V}$; $T_{VJ} = 25^{\circ}\text{C}$ $T_{VJ} = 125^{\circ}\text{C}$ | 2.4 | 2.8 | V |
| | | 1.8 | | V |
| I_{RM} | $I_F = 30\text{ A}$; $di_F/dt = -500\text{ A}/\mu\text{s}$; $T_{VJ} = 125^{\circ}\text{C}$ $V_R = 600\text{ V}$; $V_{GE} = 0\text{ V}$ | 27 | | A |
| t_{rr} | | 150 | | ns |
| R_{thJC} | (per diode) | | 1.19 | K/W |

Brake Chopper T7

| Symbol | Conditions | Maximum Ratings | |
|----------------------------|--|---|---------------|
| V_{CES} | $T_{VJ} = 25^{\circ}\text{C}$ to 150°C | 1200 | V |
| V_{GES} | Continuous | ± 20 | V |
| I_{C25} | $T_C = 25^{\circ}\text{C}$ | 35 | A |
| I_{C80} | $T_C = 80^{\circ}\text{C}$ | 25 | A |
| RBSOA | $V_{GE} = \pm 15\text{ V}$; $R_G = 82\ \Omega$; $T_{VJ} = 125^{\circ}\text{C}$ Clamped inductive load; $L = 100\ \mu\text{H}$ | $I_{CM} = 35$ $V_{CEK} \leq V_{CES}$ | A |
| t_{SC} (SCSOA) | $V_{CE} = V_{CES}$; $V_{GE} = \pm 15\text{ V}$; $R_G = 82\ \Omega$; $T_{VJ} = 125^{\circ}\text{C}$ non-repetitive | 10 | μs |
| P_{tot} | $T_C = 25^{\circ}\text{C}$ | 180 | W |

| Symbol | Conditions | Characteristic Values ($T_{VJ} = 25^{\circ}\text{C}$, unless otherwise specified) | | |
|--|--|--|--------------------------------------|----------------------------------|
| | | min. | typ. | max. |
| $V_{CE(sat)}$ | $I_C = 20\text{ A}$; $V_{GE} = 15\text{ V}$; $T_{VJ} = 25^{\circ}\text{C}$ $T_{VJ} = 125^{\circ}\text{C}$ | | 2.3 2.6 | 3.0 V V |
| $V_{GE(th)}$ | $I_C = 0.6\text{ mA}$; $V_{GE} = V_{CE}$ | 4.5 | | 6.5 V |
| I_{CES} | $V_{CE} = V_{CES}$; $V_{GE} = 0\text{ V}$; $T_{VJ} = 25^{\circ}\text{C}$ $T_{VJ} = 125^{\circ}\text{C}$ | | 0.8 | 0.8 mA mA |
| I_{GES} | $V_{CE} = 0\text{ V}$; $V_{GE} = \pm 20\text{ V}$ | | | 200 nA |
| $t_{d(on)}$ t_r $t_{d(off)}$ t_f E_{on} E_{off} | Inductive load, $T_{VJ} = 125^{\circ}\text{C}$ $V_{CE} = 600\text{ V}$; $I_C = 20\text{ A}$ $V_{GE} = \pm 15\text{ V}$; $R_G = 82\ \Omega$ | | 100 75 500 70 3.1 2.4 | ns ns ns ns mJ mJ |
| C_{ies} | | $V_{CE} = 25\text{ V}$; $V_{GE} = 0\text{ V}$; $f = 1\text{ MHz}$ | 1 | nF |
| Q_{Gon} | | $V_{CE} = 600\text{ V}$; $V_{GE} = 15\text{ V}$; $I_C = 20\text{ A}$ | 70 | nC |
| R_{thJC} | | | | 0.7 K/W |

Brake Chopper D7

| Symbol | Conditions | Maximum Ratings | |
|-----------|--|-----------------|---|
| V_{RRM} | $T_{VJ} = 25^{\circ}\text{C}$ to 150°C | 1200 | V |
| I_{F25} | $T_C = 25^{\circ}\text{C}$ | 16 | A |
| I_{F80} | $T_C = 80^{\circ}\text{C}$ | 11 | A |

| Symbol | Conditions | Characteristic Values | | |
|----------------------|--|-----------------------|------------|---------------|
| | | min. | typ. | max. |
| V_F | $I_F = 20\text{ A}$; $T_{VJ} = 25^{\circ}\text{C}$ $T_{VJ} = 125^{\circ}\text{C}$ | | 3.2 2.5 | 3.6 V V |
| I_R | $V_R = V_{RRM}$; $T_{VJ} = 25^{\circ}\text{C}$ $T_{VJ} = 125^{\circ}\text{C}$ | | 0.07 | 0.06 mA mA |
| I_{RM} t_{tr} | $I_F = 10\text{ A}$; $di_F/dt = -400\text{ A}/\mu\text{s}$; $T_{VJ} = 125^{\circ}\text{C}$ $V_R = 600\text{ V}$ | | 13 110 | A ns |
| R_{thJC} | | | | 3.2 K/W |

20070912a

Temperature Sensor NTC

| Symbol | Conditions | Characteristic Values | | |
|-------------|--------------------------|-----------------------|------|------|
| | | min. | typ. | max. |
| R_{25} | $T = 25^{\circ}\text{C}$ | 4.75 | 5.0 | 5.25 |
| $B_{25/50}$ | | | 3375 | K |

Module

| Symbol | Conditions | Maximum Ratings | |
|------------|--|-----------------|--------------------|
| T_{VJ} | operating | -40...+125 | $^{\circ}\text{C}$ |
| T_{JM} | | +150 | $^{\circ}\text{C}$ |
| T_{stg} | | -40...+125 | $^{\circ}\text{C}$ |
| V_{ISOL} | $I_{ISOL} \leq 1 \text{ mA}; 50/60 \text{ Hz}$ | 2500 | V~ |
| M_d | Mounting torque (M5) | 3 - 6 | Nm |

| Symbol | Conditions | Characteristic Values | | |
|-----------------------|------------------------------|-----------------------|------|------------|
| | | min. | typ. | max. |
| $R_{\text{pin-chip}}$ | | | 5 | m Ω |
| d_S | Creepage distance on surface | 6 | | mm |
| d_A | Strike distance in air | 6 | | mm |
| R_{thCH} | with heatsink compound | 0.01 | | K/W |
| Weight | | 300 | | g |

Dimensions in mm (1 mm = 0.0394")

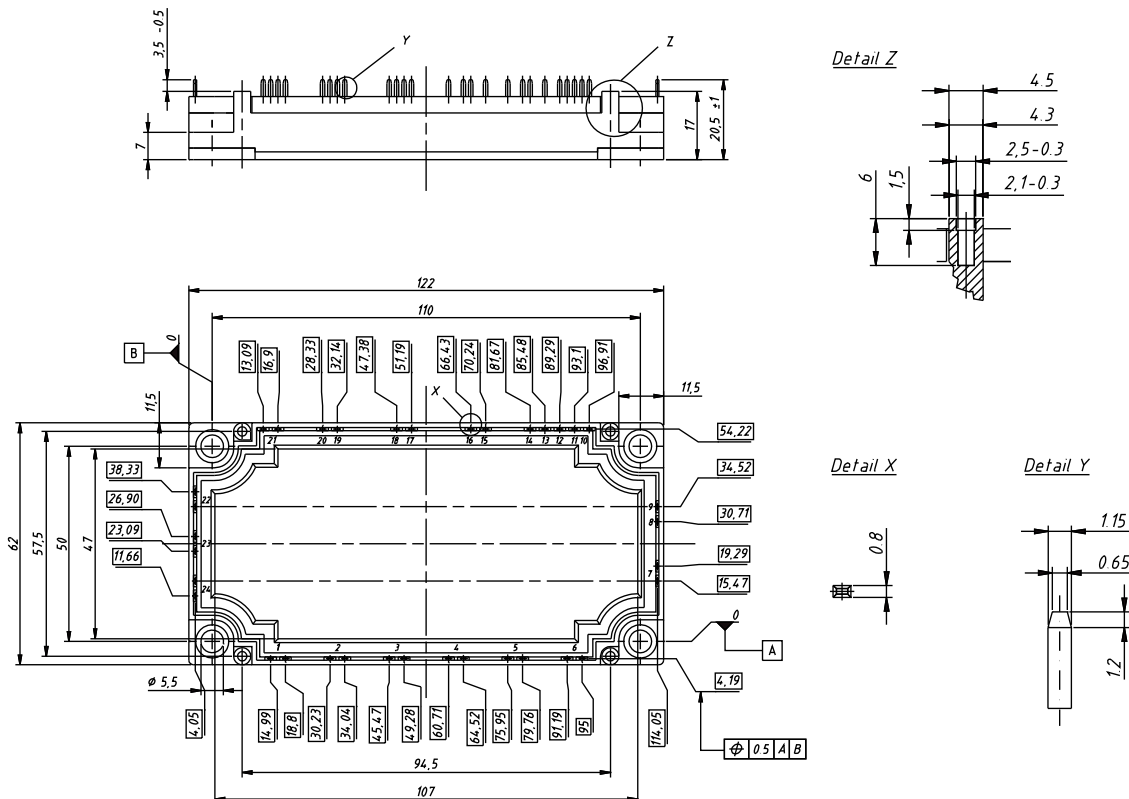

20070912a

Input Rectifier Bridge D11 - D16

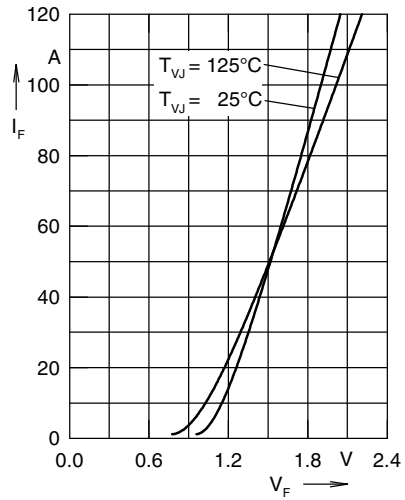

Fig. 1 Forward current versus voltage drop per diode

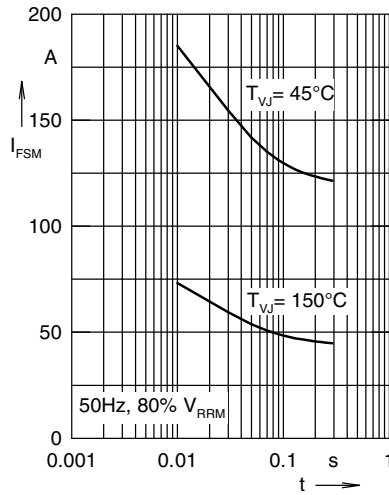

Fig. 2 Surge overload current

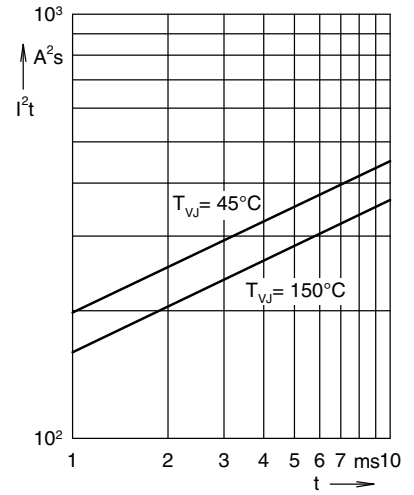

Fig. 3 I^2t versus time per diode

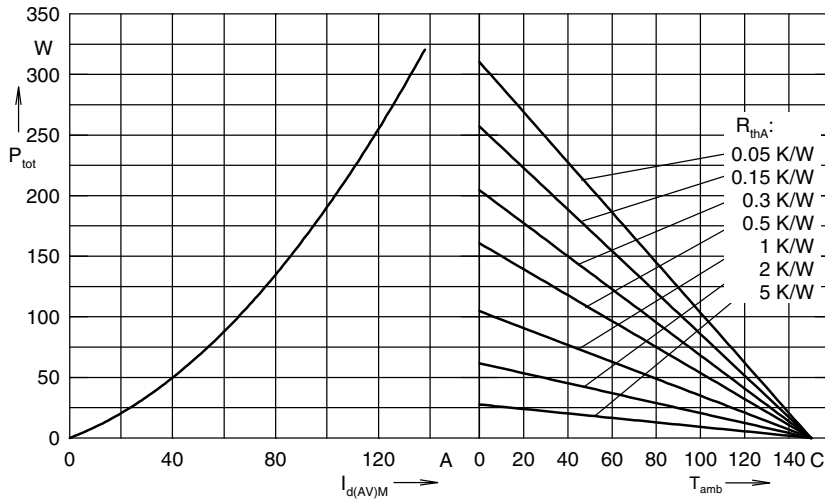

Fig. 4 Power dissipation versus direct output current and ambient temperature, sin 180°

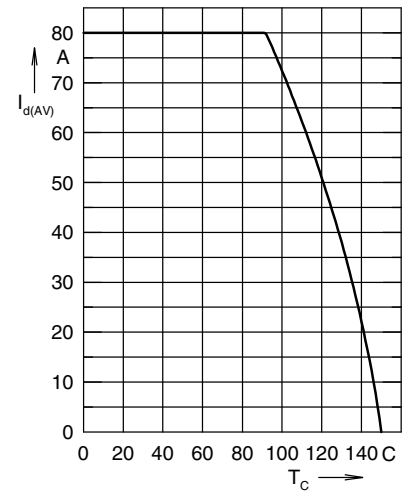

Fig. 5 Max. forward current versus case temperature

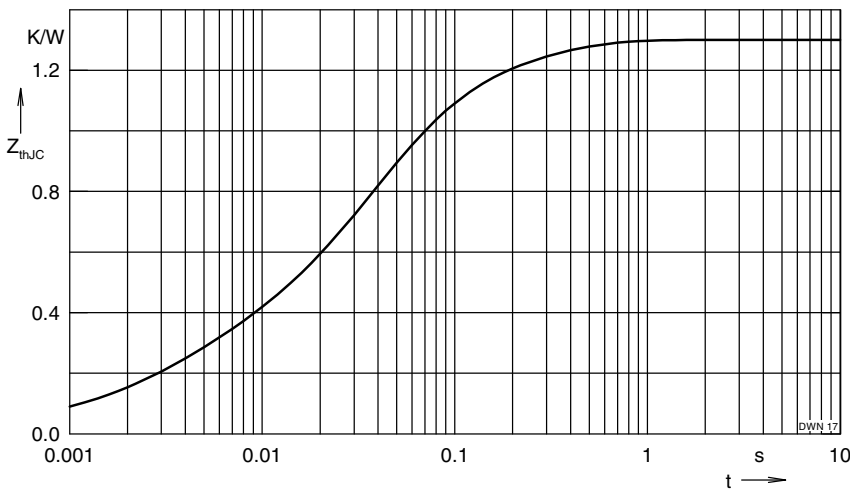

Fig. 6 Transient thermal impedance junction to case

20070912a

Output Inverter T1 - T6 / D1 - D6

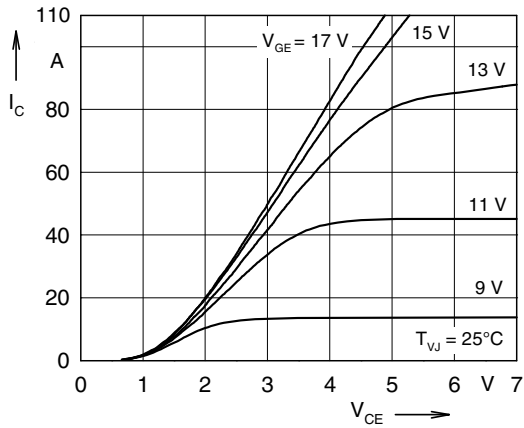

Fig. 7 Typ. output characteristics

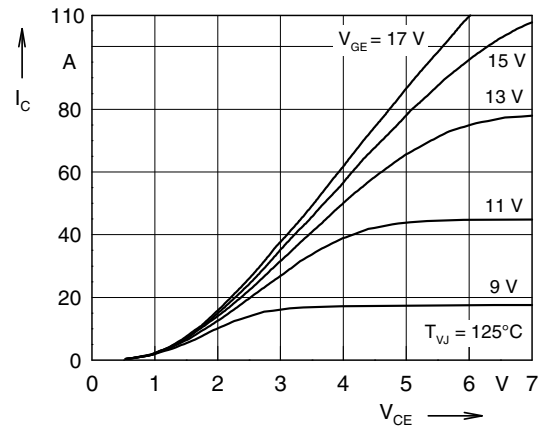

Fig. 8 Typ. output characteristics

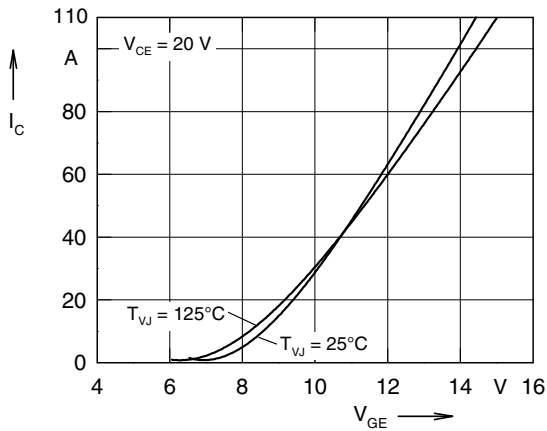

Fig. 9 Typ. transfer characteristics

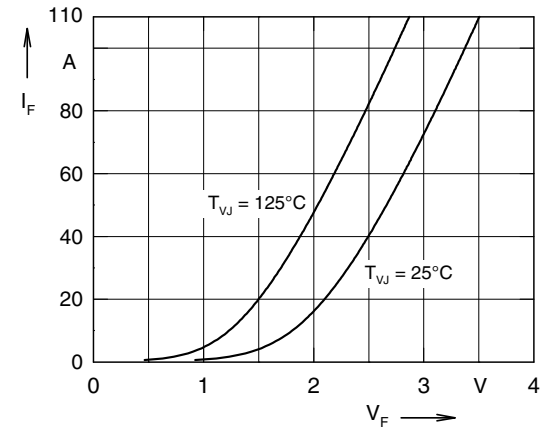

Fig. 10 Typ. forward characteristics of free wheeling diode

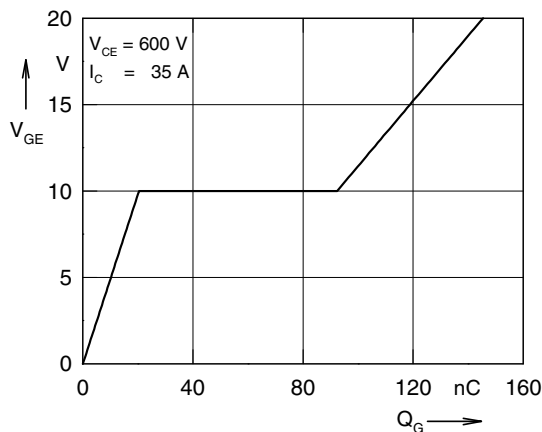

Fig. 11 Typ. turn on gate charge

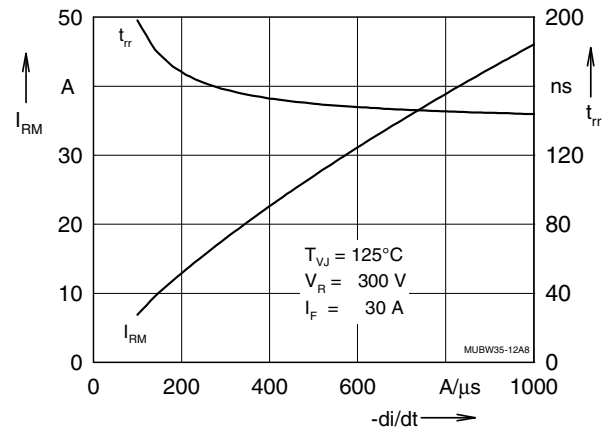

Fig. 12 Typ. turn off characteristics of free wheeling diode

Output Inverter T1 - T6 / D1 - D6

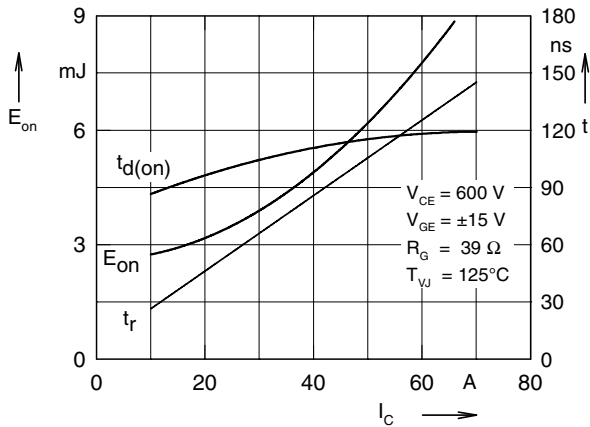

Fig. 13 Typ. turn on energy and switching times versus collector current

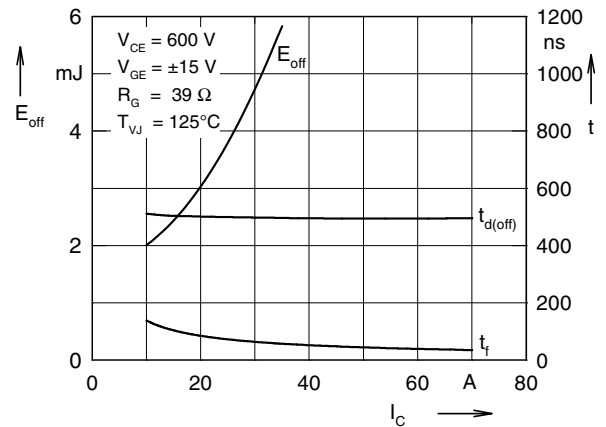

Fig. 14 Typ. turn off energy and switching times versus collector current

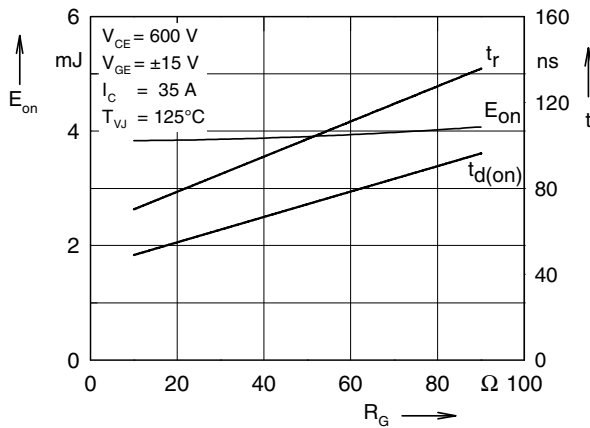

Fig. 15 Typ. turn on energy and switching times versus gate resistor

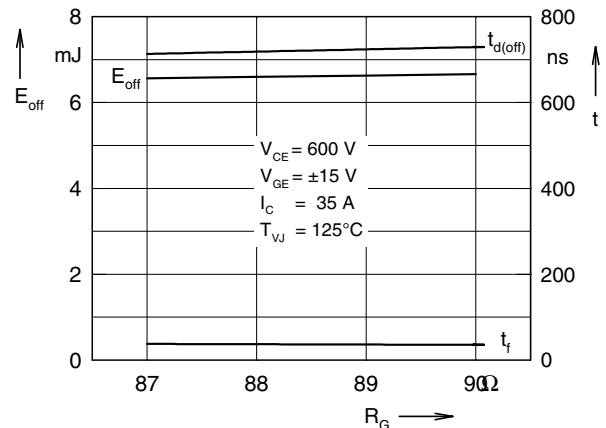

Fig. 16 Typ. turn off energy and switching times versus gate resistor

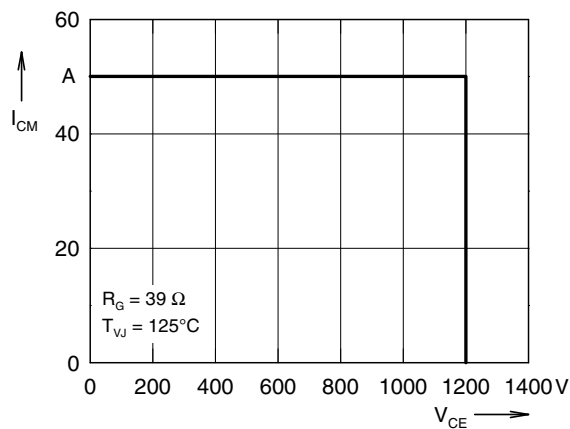

Fig. 17 Reverse biased safe operating area RBSOA

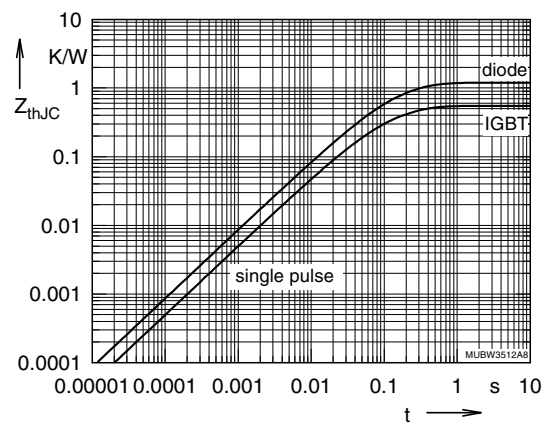

Fig. 18 Typ. transient thermal impedance

Brake Chopper T7 / D7

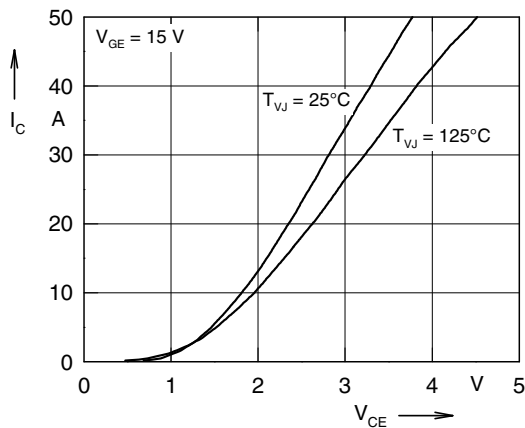

Fig. 19 Typ. output characteristics

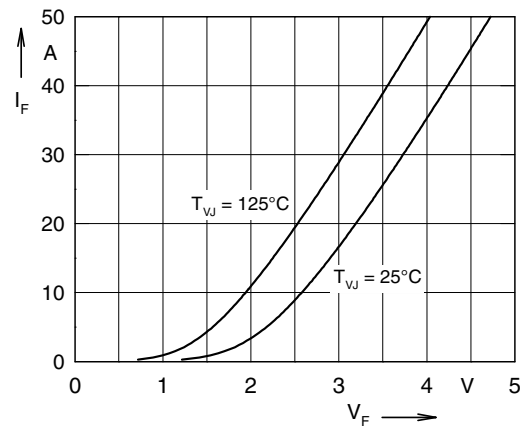

Fig. 20 Typ. forward characteristics of free wheeling diode

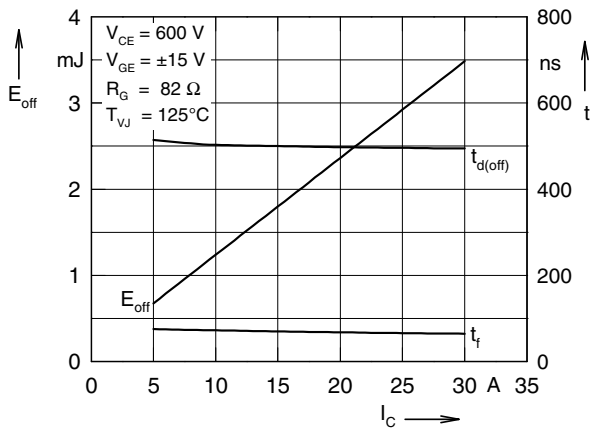

Fig. 21 Typ. turn off energy and switching times versus collector current

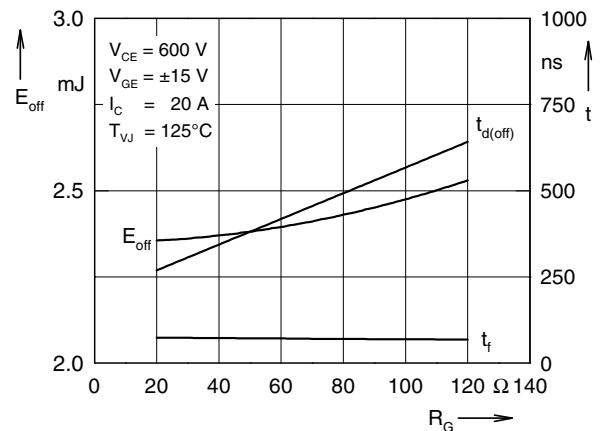

Fig. 22 Typ. turn off energy and switching times versus gate resistor

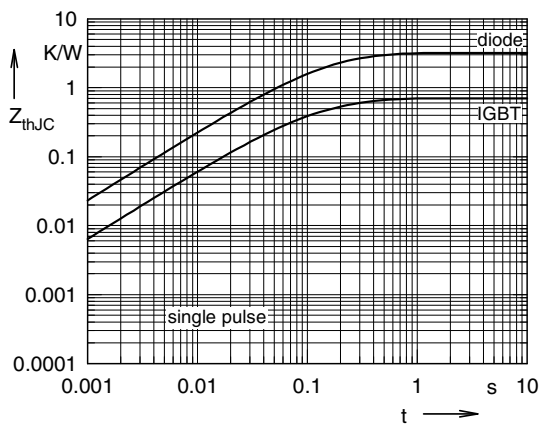

Fig. 23 Typ. transient thermal impedance

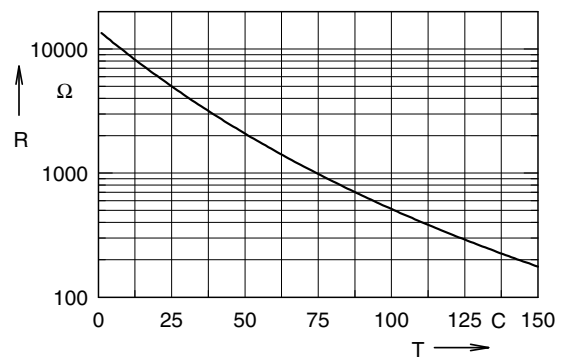

Fig. 24 Typ. thermistorresistance versus temperature

Temperature Sensor NTC