

### Dual IGBTMOD™ U-Series Module 75 Amperes/1200 Volts

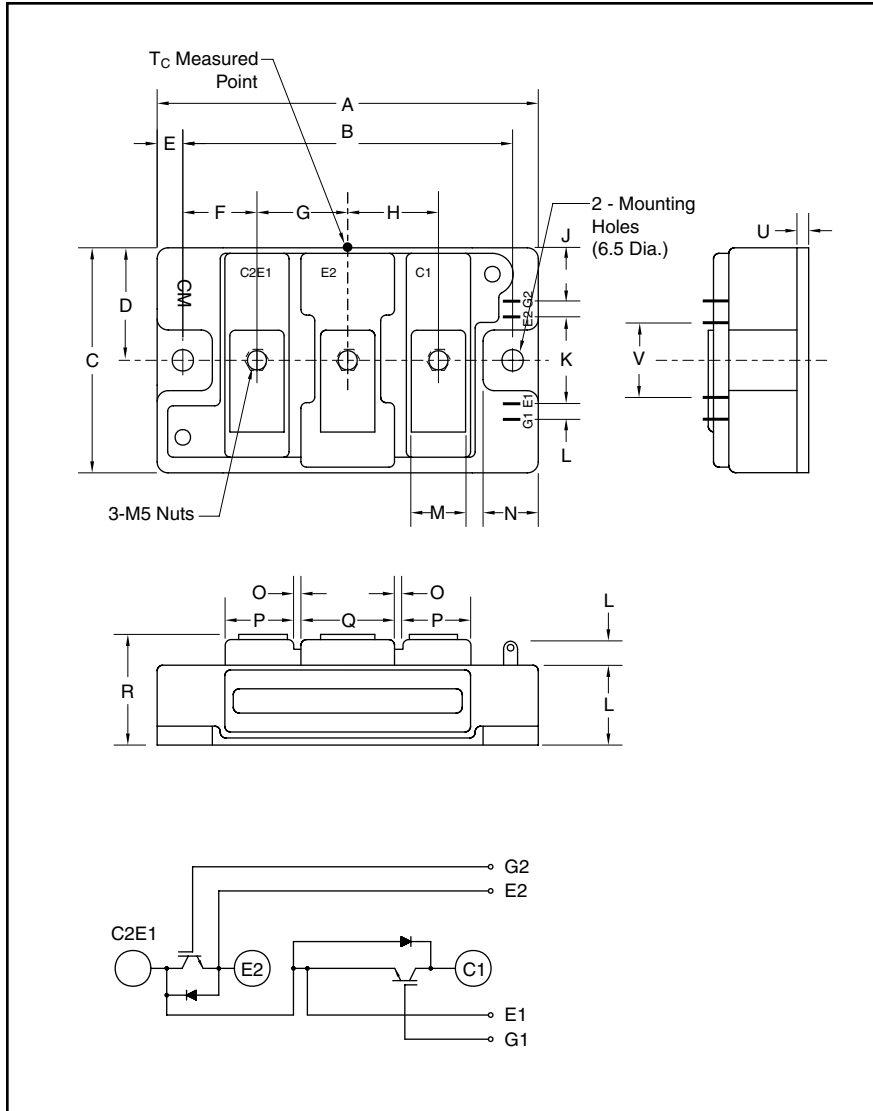

Outline Drawing and Circuit Diagram

Dimensions	Inches	Millimeters
A	3.7	94.0
B	3.15±0.01	80.0±0.25
C	1.89	48.0
D	0.94	24.0
E	0.28	7.0
F	0.67	17.0
G	0.91	23.0
H	0.91	23.0
J	0.43	11.0
K	0.71	18.0
L	0.16	4.0

Dimensions	Inches	Millimeters
M	0.47	12.0
N	0.53	13.5
O	0.1	2.5
P	0.63	16.0
Q	0.98	25.0
R	1.18 +0.04/-0.02	30.0 +1.0/-0.5
S	0.3	7.5
T	0.83	21.2
U	0.16	4.0
V	0.51	13.0



#### Description:

Powerex IGBTMOD™ Modules are designed for use in switching applications. Each module consists of two IGBT Transistors in a half-bridge configuration with each transistor having a reverse-connected super-fast recovery free-wheel diode. All components and interconnects are isolated from the heat sinking baseplate, offering simplified system assembly and thermal management.

#### Features:

- Low Drive Power
- Low  $V_{CE(sat)}$
- Discrete Super-Fast Recovery (135ns) Free-Wheel Diode
- Isolated Baseplate for Easy Heat Sinking

#### Applications:

- AC Motor Control
- Motion/Servo Control
- UPS
- Welding Power Supplies
- Laser Power Supplies

#### Ordering Information:

Example: Select the complete module number you desire from the table - i.e. CM75DU-24H is a 1200V ( $V_{CES}$ ), 75 Ampere Dual IGBTMOD™ Power Module.

Type	Current Rating Amperes	$V_{CES}$ Volts (x 50)
CM	75	24

**CM75DU-24H**  
**Dual IGBTMOD™ U-Series Module**  
 75 Amperes/1200 Volts

**Absolute Maximum Ratings,  $T_j = 25\text{ °C}$  unless otherwise specified**

Ratings	Symbol	CM75DU-24H	Units
Junction Temperature	$T_j$	-40 to 150	°C
Storage Temperature	$T_{stg}$	-40 to 125	°C
Collector-Emitter Voltage (G-E SHORT)	$V_{CES}$	1200	Volts
Gate-Emitter Voltage (C-E SHORT)	$V_{GES}$	±20	Volts
Collector Current ( $T_c = 25\text{ °C}$ )	$I_C$	75	Amperes
Peak Collector Current	$I_{CM}$	150*	Amperes
Emitter Current** ( $T_c = 25\text{ °C}$ )	$I_E$	75	Amperes
Peak Emitter Current**	$I_{EM}$	150*	Amperes
Maximum Collector Dissipation ( $T_c = 25\text{ °C}$ , $T_j \leq 150\text{ °C}$ )	$P_c$	600	Watts
Mounting Torque, M5 Main Terminal	–	31	in-lb
Mounting Torque, M6 Mounting	–	40	in-lb
Weight	–	310	Grams
Isolation Voltage (Main Terminal to Baseplate, AC 1 min.)	$V_{iso}$	2500	Volts

\* Pulse width and repetition rate should be such that the device junction temperature ( $T_j$ ) does not exceed  $T_{j(max)}$  rating.

\*\*Represents characteristics of the anti-parallel, emitter-to-collector free-wheel diode (FWDi).

**Static Electrical Characteristics,  $T_j = 25\text{ °C}$  unless otherwise specified**

Characteristics	Symbol	Test Conditions	Min.	Typ.	Max.	Units
Collector-Cutoff Current	$I_{CES}$	$V_{CE} = V_{CES}$ , $V_{GE} = 0V$	–	–	1	mA
Gate Leakage Current	$I_{GES}$	$V_{GE} = V_{GES}$ , $V_{CE} = 0V$	–	–	0.5	µA
Gate-Emitter Threshold Voltage	$V_{GE(th)}$	$I_C = 7.5mA$ , $V_{CE} = 10V$	4.5	6	7.5	Volts
Collector-Emitter Saturation Voltage	$V_{CE(sat)}$	$I_C = 75A$ , $V_{GE} = 15V$ , $T_j = 25\text{ °C}$	–	2.9	3.7	Volts
		$I_C = 75A$ , $V_{GE} = 15V$ , $T_j = 125\text{ °C}$	–	2.85	–	Volts
Total Gate Charge	$Q_G$	$V_{CC} = 600V$ , $I_C = 75A$ , $V_{GE} = 15V$	–	280	–	nC
Emitter-Collector Voltage*	$V_{EC}$	$I_E = 75A$ , $V_{GE} = 0V$	–	–	3.2	Volts

\*\*Represents characteristics of the anti-parallel, emitter-to-collector free-wheel diode (FWDi).

**Dynamic Electrical Characteristics,  $T_j = 25\text{ °C}$  unless otherwise specified**

Characteristics	Symbol	Test Conditions	Min.	Typ.	Max.	Units	
Input Capacitance	$C_{ies}$		–	–	11	nf	
Output Capacitance	$C_{oes}$	$V_{CE} = 10V$ , $V_{GE} = 0V$	–	–	3.7	nf	
Reverse Transfer Capacitance	$C_{res}$		–	–	2.2	nf	
Resistive	Turn-on Delay Time	$t_{d(on)}$	$V_{CC} = 600V$ , $I_C = 75A$ ,	–	–	100	ns
Load	Rise Time	$t_r$	$V_{GE1} = V_{GE2} = 15V$ ,	–	–	200	ns
Switch	Turn-off Delay Time	$t_{d(off)}$	$R_G = 4.2\Omega$ , Resistive	–	–	250	ns
Times	Fall Time	$t_f$	Load Switching Operation	–	–	350	ns
Diode Reverse Recovery Time**	$t_{rr}$	$I_E = 75A$ , $di_E/dt = -150A/\mu s$	–	–	300	ns	
Diode Reverse Recovery Charge**	$Q_{rr}$	$I_E = 75A$ , $di_E/dt = -150A/\mu s$	–	0.41	–	µC	

\*\*Represents characteristics of the anti-parallel, emitter-to-collector free-wheel diode (FWDi).

**Thermal and Mechanical Characteristics,  $T_j = 25\text{ °C}$  unless otherwise specified**

Characteristics	Symbol	Test Conditions	Min.	Typ.	Max.	Units
Thermal Resistance, Junction to Case	$R_{th(j-c)Q}$	Per IGBT 1/2 Module	–	–	0.21	°C/W
Thermal Resistance, Junction to Case	$R_{th(j-c)D}$	Per FWDi 1/2 Module	–	–	0.47	°C/W
Contact Thermal Resistance	$R_{th(c-f)}$	Per Module, Thermal Grease Applied	–	0.035	–	°C/W

**CM75DU-24H**  
**Dual IGBTMOD™ U-Series Module**  
 75 Amperes/1200 Volts

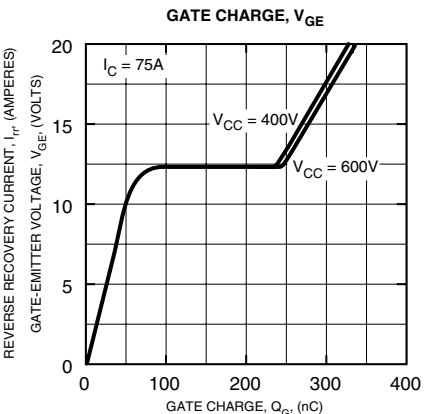
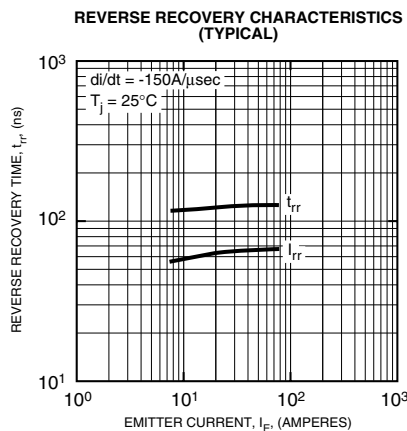
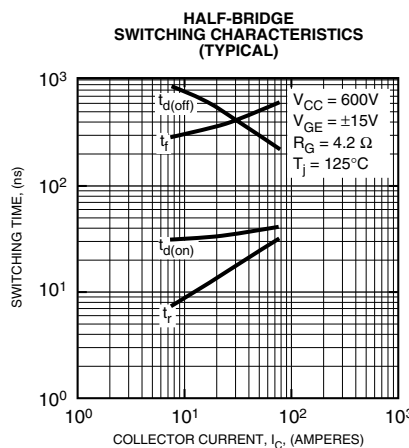
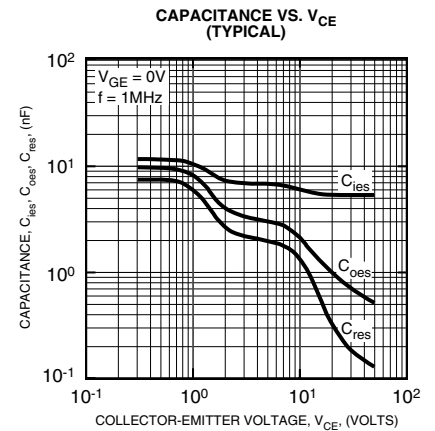
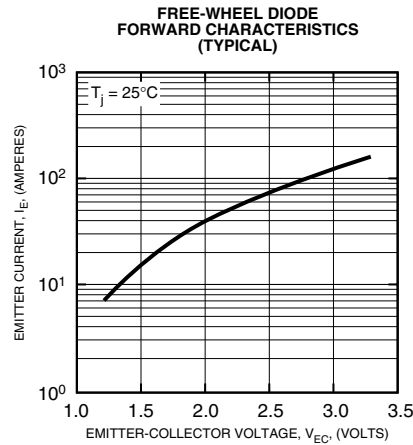
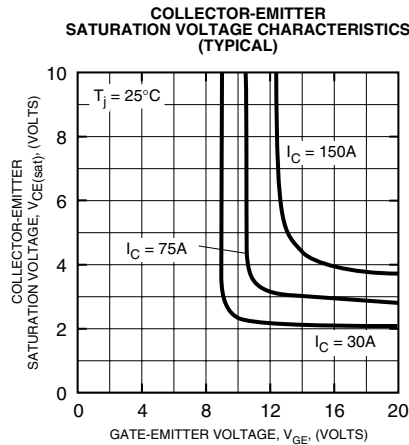
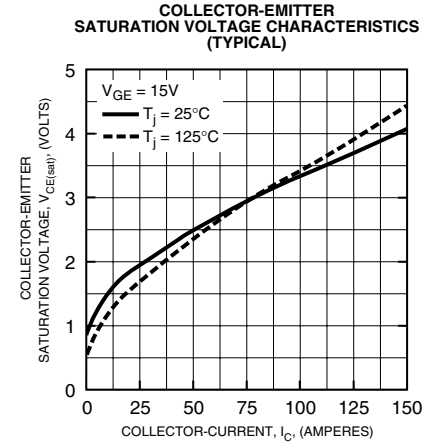
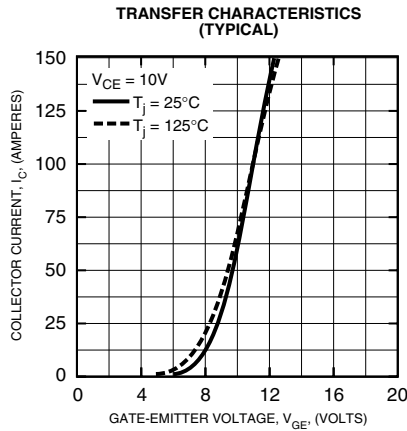
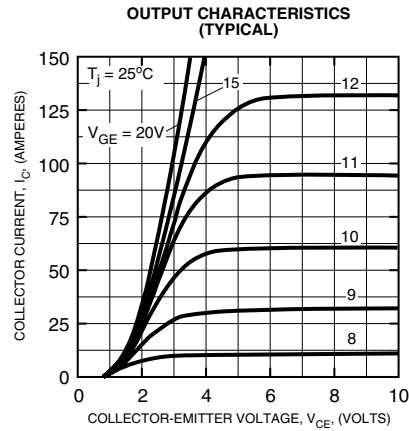

**CM75DU-24H**  
**Dual IGBTMOD™ U-Series Module**  
 75 Amperes/1200 Volts

