

PBA series

Piezo switches

Distinctive features - Specifications - Overview

- Sealed to IP 68 (switches mounted on panel)
- Easy to clean metal surface
- Long life
- Ring or dot illumination

B

ELECTRICAL SPECIFICATIONS

- Rated voltage : 5V to 24 VAC/DC max.
- Rated current : 0,2A to 1A max.
- Switch resistance ON : 10Ω max.
- Switch resistance OFF : 5MΩ min.
- Switch capacitance : 25pF
- LED : 20mA 5VDC

MATERIALS

- Case : aluminium, anodized or stainless steel
- Terminals : multi-wire leads AWG24, length 300 mm (11.81)

GENERAL SPECIFICATIONS

- Operating force : 2 to 6N
- Life expectancy : 50 million cycles
- Operating temperature : -40°C to +75°C
- EMC compatibility according to EN 61058-1 for the whole range
- EMC compatibility according to EN 61000-4 & EN61000-6-2 for model 1A (code 002)
- Sealing : IP 68 per IEC 529 (switches mounted on panel)

Standard hardware supplied :

1 hex nut U4116 (19 mm ac. flats) or
1 hex nut U6440 (25 mm across flats)

Packaging unit :

Bushing Ø 16 (.629) : 40 pieces
Bushing Ø 22 (.866) : 20 pieces

Dimensions : first dimensions are in mm while inches are shown as bracketted numbers.

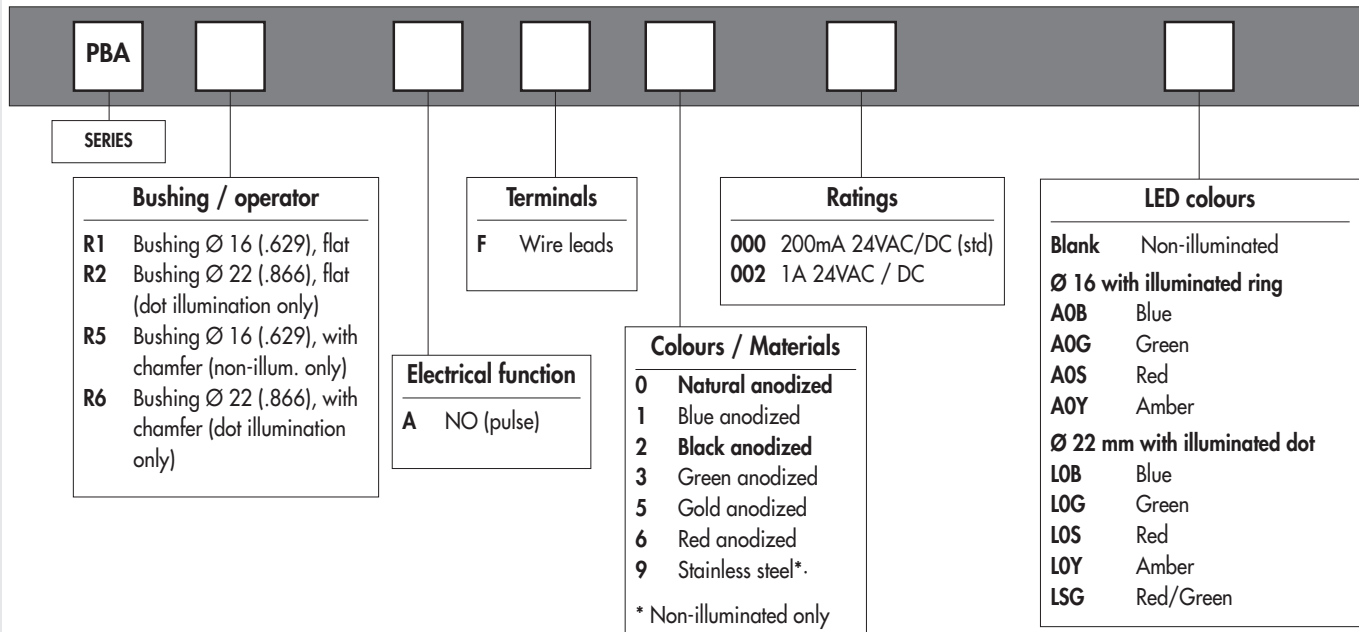

NOTICE : please note that not all combinations of above numbers are available. Refer to the following pages for further information.

PBA series

Piezo switches

Bushing \varnothing 16 (.629) - illuminated and non-illuminated

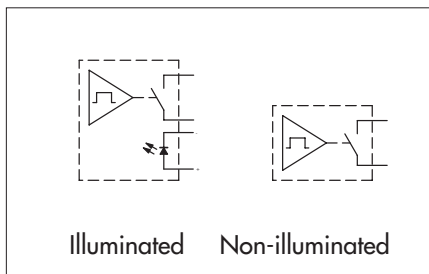

- Panel cut-out : \varnothing 16,2 mm (.637)
- Operator \varnothing 18 mm (.708)

MODEL STRUCTURE

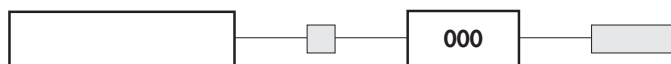

With illuminated ring



Flat operator
PBAR1AF

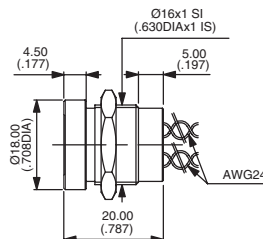

Wire colours : red : contact, yellow : LED anode (+), blue : LED cathode (-)

Non-illuminated



Flat operator
PBAR1AF
With chamfer
PBAR5AF

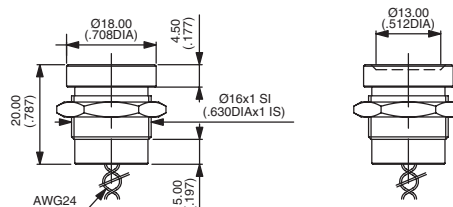

CASE COLOURS / MATERIALS



0 : natural anodized aluminium - 1 : blue anodized alum. - 2 : black anodized alum. - 3 : green anodized alum.
5 : gold anodized alum. - 6 : red anodized alum. - 9 : stainless steel (non-illum. only)

LED COLOURS



Blank : non-illuminated

A0B : blue - A0G : green - A0S : red - A0Y : amber

B

PBA series

Piezo switches

Bushing $\varnothing 22 (.866)$ - illuminated and non-illuminated

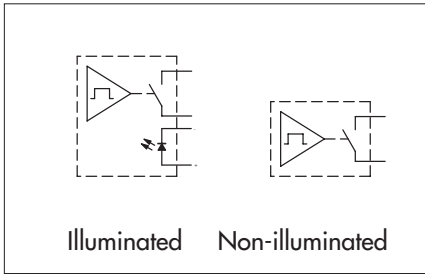

- Panel cut-out : $\varnothing 22,2 \text{ mm} (.874)$
- Operator $\varnothing 28 \text{ mm} (1.102)$

MODEL STRUCTURE

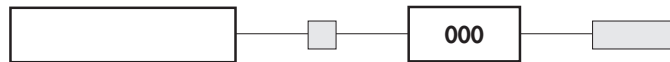

Wire colours : red : contact, yellow : LED anode (+), blue : LED cathode (-)

With illuminated dot



Flat operator
PBAR2AF
With chamfer
PBAR6AF

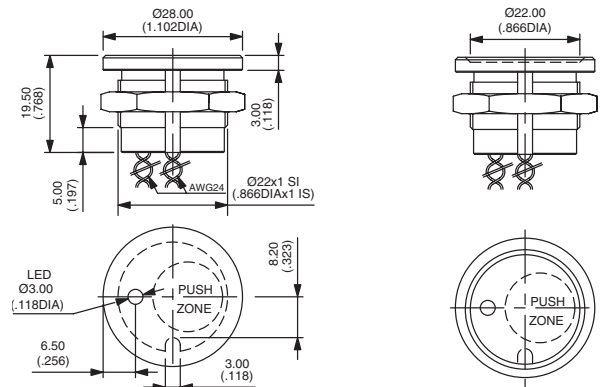

Non-illuminated



Flat operator
PBAR2AF
With chamfer
PBAR6AF

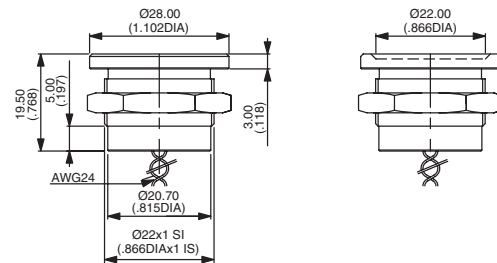

CASE COLOURS / MATERIALS



0 : natural anodized aluminium - **1** : blue anodized alum. - **2** : black anodized alum. - **3** : green anodized alum.
5 : gold anodized alum. - **6** : red anodized alum. - **9** : stainless steel (non-illum. only)

LED COLOURS



Blank : non-illuminated

LOB : blue - **LOG** : green - **LOS** : red - **LOY** : amber - **LSG** : red/green