

TP series

Tiny washable momentary pushbutton switches

Distinctive features and specifications



☐ Sealed

- Single piece case
- O-ring seal between actuator and bushing
- Epoxy sealed terminals

☐ Wide variety of contact materials

☐ Same PCB layout as TL, TR and TG tiny switches

ELECTRICAL SPECIFICATIONS

- Max. current/voltage rating with resistive load :
 - gold plated contacts : 0,4VA 20V max. AC or DC
 - silver plated contacts : 0,5A 48V max. AC or DC
- Minimum load : 10mA 50mV - 10 μ A 5VDC
- Contact resistance : 50 m Ω max.
- Insulation resistance : 1.000 M Ω min. at 500VDC
- Dielectric strength :
 - 1.000 Vrms 50 Hz min. between terminals and frame
 - 500 Vrms 50 Hz min. between terminals
- Electrical life at full load :
 - gold plated contacts : 60.000 cycles
 - silver plated contacts : 20.000 cycles

GENERAL SPECIFICATIONS

- Total travel :
 - function 2 : 1 mm (.039)
 - function 3 : 0,8 mm (.031)
- Strength of terminals : pull-out force - 10N max.
- Operating temperature : -30°C to +85°C
- Moisture : 21 days 95 % (NFC 20-603 - IEC 68-2-3)
- Cleaning : solvents or water + detergent
- Wave soldering : 260°C - 5 sec.

MATERIALS

- Case : PBT
- Actuator : polyamide, glass filled
- Contacts and terminals :
 - 0** : brass, gold plated
 - 1** : brass, silver plated
 - 3** : brass, gold plated (1,27 micron gold)
 - 8** : contact brass, gold plated + tin plated terminals
 - 9** : contact brass, gold plated (1,27 micron gold) + tin plated terminals
- Terminal seal : epoxy

B

TP series

Tiny washable momentary pushbutton switches

Overview

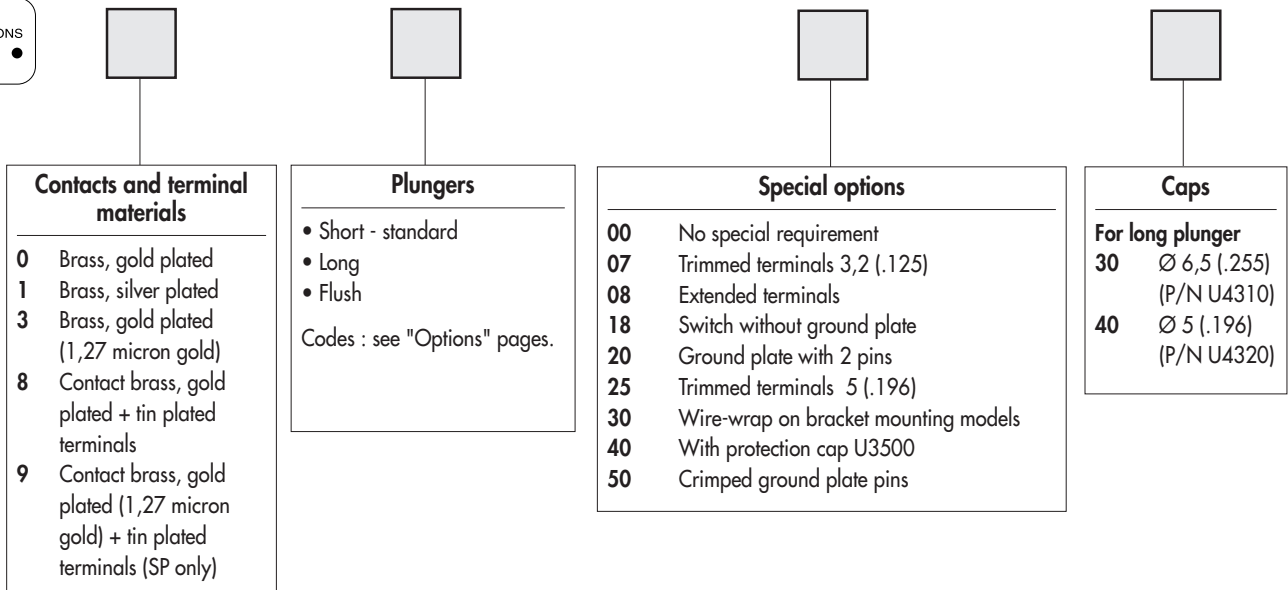
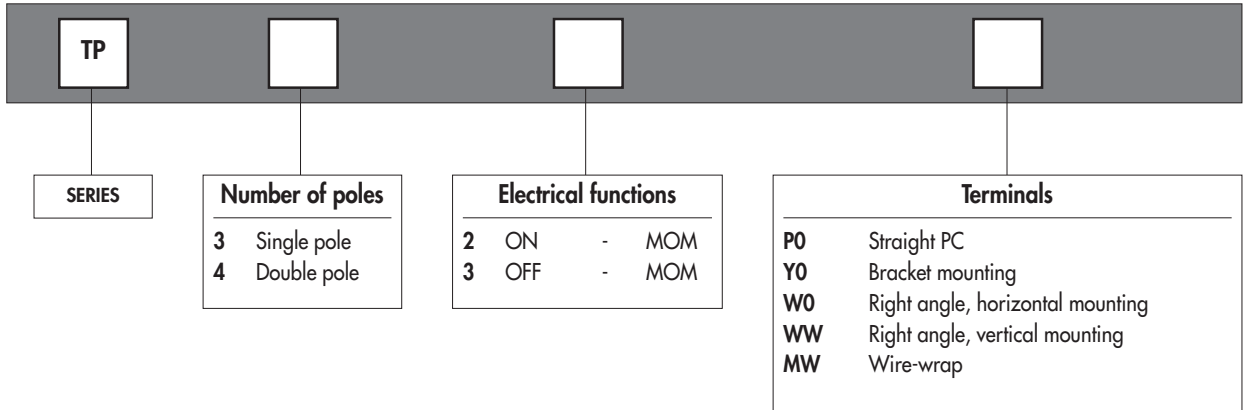

ABOUT THIS SERIES

On the following pages, you will find successively :

- model structure of switches
- options in the same order as in above chart

Dimensions : first dimensions are in mm while inches are shown as bracketted numbers.



NOTICE : please note that not all combinations of above numbers are available. Refer to the following pages for further information.



Packaging unit : 100 pieces, except for models with WW terminals (50 pieces).



TP series

Tiny washable momentary pushbutton switches

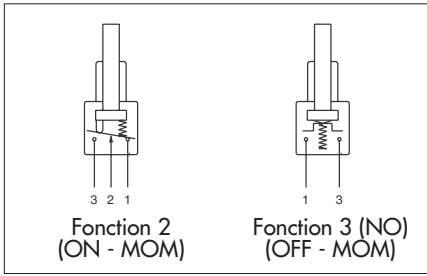

- Straight PC, right angle or wire-wrap terminals
- 1 and 2 pole configurations

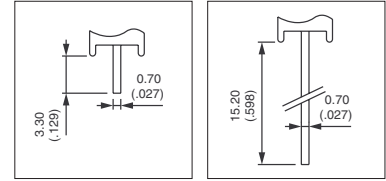

MODEL STRUCTURE

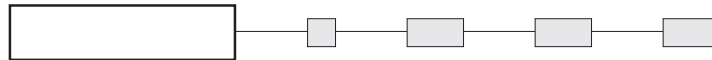

Shown in function 2, with standard plunger

Straight PC terminals : TP..PO



	Single pole	Double pole	ON	MOM
TP32PO		TP42PO		
TP33PO		TP43PO	OFF	MOM

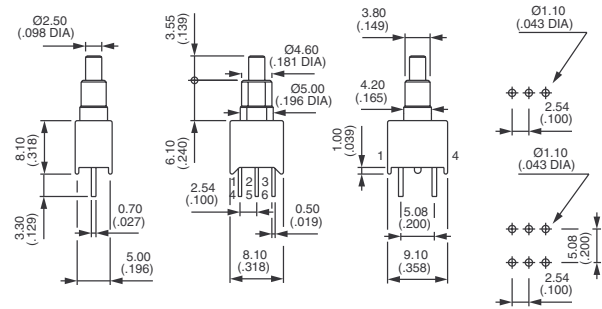

Function 3 has two terminals only (3 and 1) per pole

Straight terminals - bracket mounting : TP..YO



	Single pole	Double pole	ON	MOM
TP32YO		TP42YO		
TP33YO		TP43YO	OFF	MOM

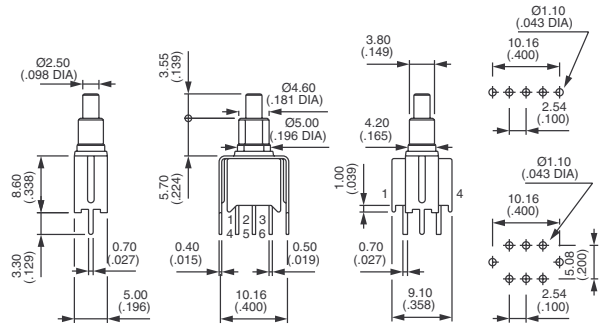

Function 3 has two terminals only (3 and 1) per pole

Right angle terminals - horizontal mounting : TP..WO



	Single pole	Double pole	ON	MOM
TP32WO		TP42WO		
TP33WO		TP43WO	OFF	MOM

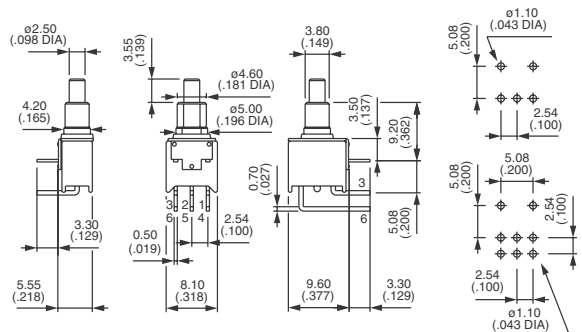

Function 3 has two terminals only (3 and 1) per pole

B

TP series

Tiny washable momentary pushbutton switches



Shown in function 2, with standard plunger

Right angle terminals - vertical mounting : TP..WW



Single pole	Double pole	ON	MOM
TP32WW	TP42WW	ON	MOM
TP33WW	TP43WW	OFF	MOM

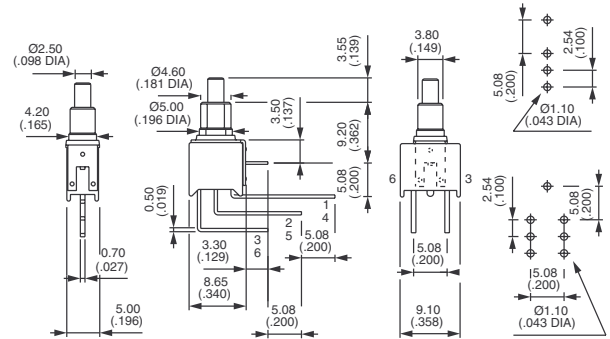

Function 3 has two terminals only (3 and 1) per pole

Wire-wrap terminals : TP..MW



Single pole	Double pole	ON	MOM
TP32MW	TP42MW	ON	MOM
TP33MW	TP43MW	OFF	MOM

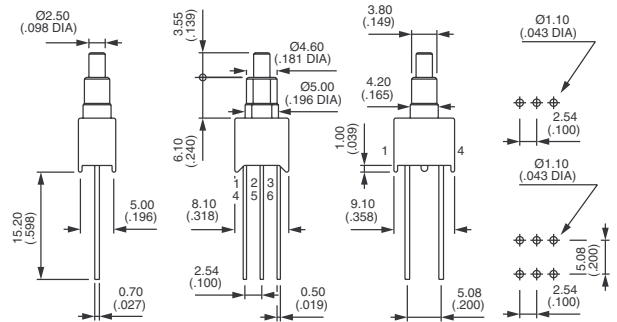

Function 3 has two terminals only (3 and 1) per pole

PCB MOUNTING

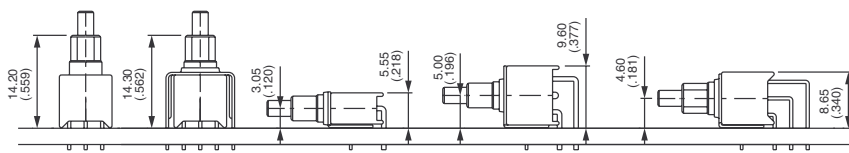

CAP FOR PCB PROCESSING

Provide additional protection during PCB processing.
 Supplied separately. For cap mounted on the switch, see special option 40.
 Material : vinyl

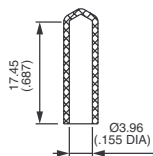

U3502

B



TP series

Tiny washable momentary pushbutton switches

CONTACT AND TERMINAL MATERIALS

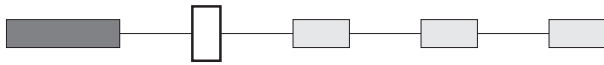

- 0 Brass, gold plated
- 1 Brass, silver plated
- 3 Brass, gold plated (1,27 micron gold)
- 8 Contact brass, gold plated + tin plated terminals
- 9 Contact brass, gold plated (1,27 micron gold) + tin plated terminals (single pole only)

PLUNGERS



Standard plunger colour is black.

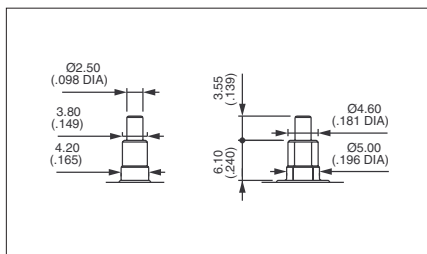

Short - standard

With blue case
30

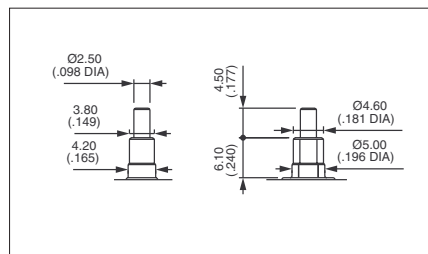

Long

With blue case
35

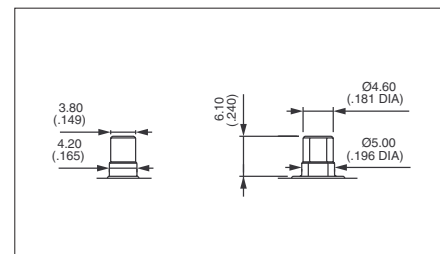

Flush

With black case
82

SPECIAL OPTIONS

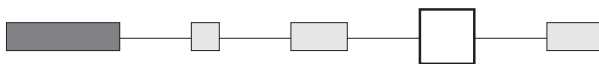

- 00 No special requirement
- 07 **Trimmed terminals** - length 3,2 mm (.125) for TP..WW models only
- 08 **Extended terminals** for TP..W0 models only

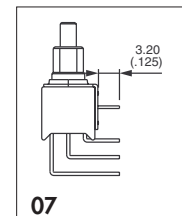

07

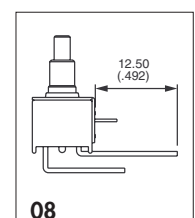

08

TP series

Tiny washable momentary pushbutton switches



SPECIAL OPTIONS (continued)

- 18 Switch **without ground plate** for TP..WW models only
- 20 **Ground plate with 2 pins** for TP..WW models only
- 25 **Trimmed terminals** - length 5 mm (.196) for all models, except TP..WW
- 30 **Wire-wrap terminals** on models with mounting **bracket**
- 40 With cap U3500 mounted over plunger and bushing
Further protects the switch during PCB processing
- 50 **Crimping of ground plate pins.**
Retains switch on PC during handling and wave soldering.
For models TP..W0, TP..WW and TP..Y0 single and double pole.

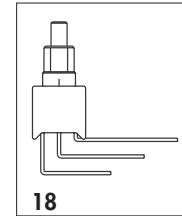

18

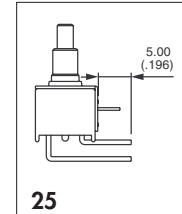

25

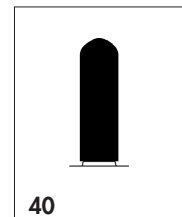

40

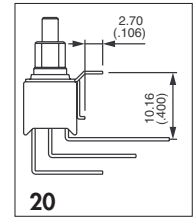

20

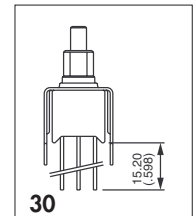

30

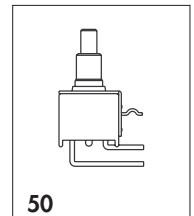

50

CAPS

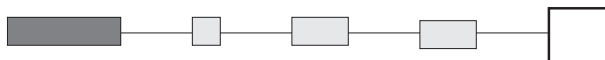

Blank Without cap

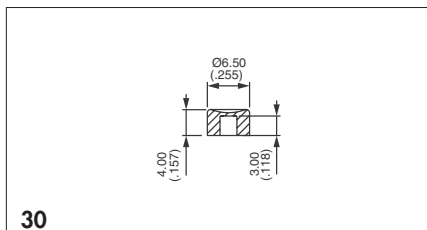

30

P/N U4310 - for long plunger only

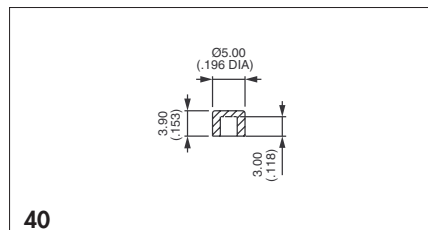

40

P/N U4320 - for long plunger only

To order caps separately, use their part number (U...).

Cap colours

Replace "0" by number

- 1 blue
- 1/4 dark blue
- 2 black
- 3 green
- 4 grey
- 5 yellow
- 6 red
- 7 ivory
- 7/1 white
- 9 orange