

SUGGESTED PANEL CUTOUT

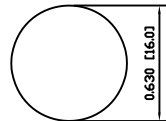

MAXIMUM PANEL THICKNESS: 0.551 [14.0mm]

SCHEMATIC

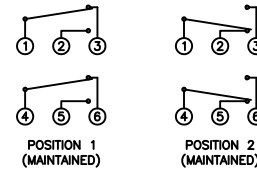

SPECIFICATIONS

FUNCTION:
2P2T ON-ON

RATING:
NOM-003-SCFI-2000 (200901C07839):
2A 48VDC [NOM]

CONTACT RESISTANCE:
Initial: 50mΩ Max. at 1A 12VDC

INSULATION RESISTANCE:
1,000MΩ Min. at 500VDC

DIELECTRIC STRENGTH:
2,000VAC Min. for 1 Minute

ELECTRICAL LIFE:
50,000 Cycles

MECHANICAL LIFE:
200,000 Cycles

TEMPERATURE:
Operating: -20°C to 55°C

APPROVALS:
NOM RoHS
COMPLIANT

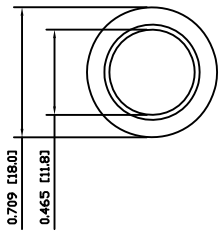

0.709 [18.0]
0.465 [11.8]

0.791±0.039 [20.1±1.0]
1.142±0.039 [29.0±1.0]
1.378±0.039 [35.0±1.0]
1.417±0.039 [36.0±1.0]

0.154±0.020 [3.9±0.5]
0.059 [1.5]

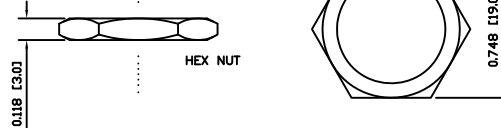
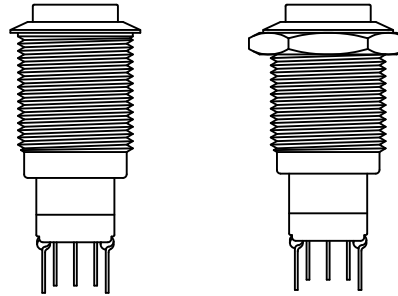
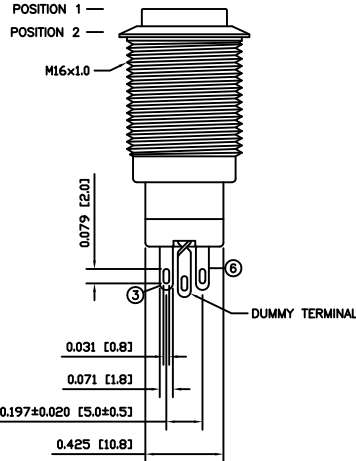
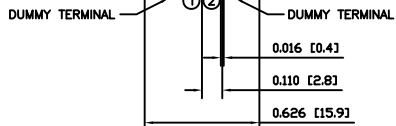

EXPLODED VIEW

ASSEMBLED VIEW

COLORS AND FINISH

BEZEL:
Stainless Steel
Polished Finish

ACTUATOR:
Stainless Steel
Polished Finish

ILLUMINATION:
None

MARKING:
None

MATERIALS

BUSHING:
Stainless Steel (304)

BASE:
Polybutylene Terephthalate (PBT)
Polycarbonate (PC)

ACTUATOR:
Stainless Steel (304)
Polycarbonate (PC)

HARDWARE:
Nickel Plated Brass (H59)

INNER ASSEMBLY:
Polyoxymethylene (POM)
Polycarbonate (PC)
Polybutylene Terephthalate (PBT)
Silver Plated Brass (H62)
Beryllium Copper

SPRING:
Stainless Steel (304)

CONTACTS:
Silver/Cadmium Oxide (AgCdO)

TERMINALS:
Silver Plated Brass (H62)

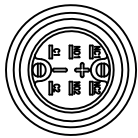

BODY	A	09/07/13	CAB
COLORS	A	09/07/10	CAB
MATERIALS	B	10/01/11	CAB
SPECIFICATIONS	B	09/12/23	CAB
REFERENCE	REV.	DATE	BY

THE INFORMATION CONTAINED IN THIS DOCUMENT IS PROPRIETARY TO E-SWITCH AND IS NOT TO BE COPIED OR TRANSFERRED

D	CORRECTED THE FUNCTION TO MAINTAINED	19371	10/10/21	CAB
C	ADDED NOM RATING	PCRD0135	10/01/11	CAB
B	CORRECTED THE ACTUATOR TYPE AND FUNCTION	PCRD0165	09/10/14	CAB
A	INITIAL RELEASE	PCRD0051	09/08/05	CAB
REV.	DESCRIPTION	PCR	DATE	DRAWN BY

DIMENSIONS	
INCHES [MILLIMETERS]	
GENERAL TOLERANCES	
±0.008 [±0.2] / ±1'	
SCALE	PROJECTION
DRAWING NOT TO SCALE	1st Angle

E-SWITCH | **LAMB INDUSTRIES**

TITLE: **PV3H2GOSS**

ITEM NUMBER: **52-PV3H2GOSS** | DATE: **OCTOBER 21, 2010** | REVISION: **D**