

Data Sheet 1.14.002.--- Short-Travel Switch MICON 5



SMT standard version



SMT low version



THT standard version

Order no.	Terminals	Height [mm]	Operating Force F1 [N] (+- 20%)	Switching Travel S2 [mm] (+- 0.15 mm)	Operating life [operations] (testing force)	Product code
1.14.002.101/0000	SMT	standard 3.85	3.0	0.7	1,000,000 (4 N)	X
1.14.002.001/0000	SMT	standard 3.85	4.5	0.8	250,000 (6 N)	Z
1.14.002.111/0000	SMT	standard 3.85	5.5	0.9	1,000,000 (8 N)	W
1.14.002.011/0000	SMT	standard 3.85	8.0	1.1	250,000 (12 N)	Y
1.14.002.301/0000*	SMT	standard 3.85	3.5	0.85	250,000 (6 N)	K
1.14.002.103/0000	SMT	low 3.45	3.0	0.6	1,000,000 (4 N)	S
1.14.002.003/0000	SMT	low 3.45	4.5	0.7	250,000 (6 N)	T
1.14.002.113/0000	SMT	low 3.45	5.5	0.7	1,000,000 (8 N)	R
1.14.002.106/0000	THT	standard 3.85	3.0	0.7	1,000,000 (4 N)	O
1.14.002.006/0000	THT	standard 3.85	4.5	0.8	250,000 (6 N)	Q
1.14.002.116/0000	THT	standard 3.85	5.5	0.9	1,000,000 (8 N)	N
1.14.002.016/0000	THT	standard 3.85	8.0	1.1	250,000 (12 N)	P

* low noise

Dimensions

Length	6.4 mm
Width	5.1 mm
Height	see order block above

Mechanical Design

Mounting	soldering
Terminals	SMT L- inward, tin-plated (lead free) or THT
Contact system	snap-action contact (snap disc)
Contact arrangement	1 NO
Contact materials	gold (Au)

Mechanical Characteristics

Operating force F_1	see order block above
Switching travel S_2	see order block above

Force/travel diagram

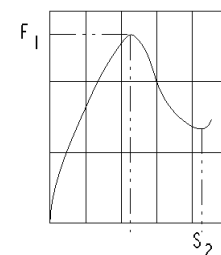

Electrical Characteristics

Rated voltage	0.02 - 42 V DC
Rated current	0.01 - 100 mA
Rated power max.	1 W (Ohmic load)
Contact resistance	< 100 mΩ
Bouncing time	< 5 ms
Insulation resistance	min. 10 ⁹ Ω
Dielectric strength	250 V AC

Other Specifications

Ambient temperature operating	-40°C ... +85°C
Ambient temperature storage	-50°C ... +95°C
Resistance to vibrations	5 g acc. to. IEC 600 68-2-6
Resistance to constant environment	IEC 600 68-2-78 and 2-30
Resistance to variable environment	IEC 600 68-2-14 and 2-33
Flammability of materials	UL 94 V1
Operating life	see order block

Solderability

SMT version	DIN IEC 60068-2-58 and DIN EN 61 760-1
THT version	E DIN IEC 60068-2-20

Standard packaging

SMT version	tape with 2100 pieces
THT version	tube with 102 pieces

Circuit Diagram acc. to IEC 617

The connection between the two outer contact lanes is only ensured in the operated state.

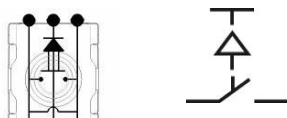

Product Code acc. to (EN ISO 8402) DIN EN ISO 9001

Traceability acc. to (EN ISO 8402) DIN EN ISO 9001, 2000, 7.5.3

A 7-digit code is printed on the housing of the keyswitch. This code informs about production date, production shift and type of product:

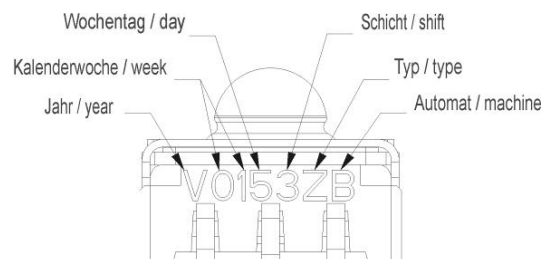

SMT Version

**Dimensional drawing
 SMT standard version**

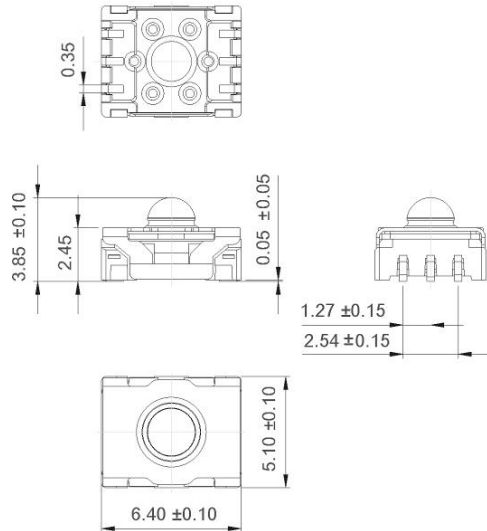

**Dimensional drawing
 SMT low version**

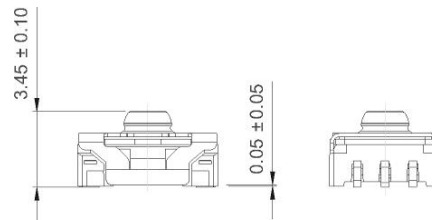

**Soldering foot print
 SMT version**

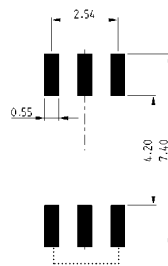

Mounting Hints

Pipette

Special pipette (Siemens Siplace order no.: 348514-02)
 mounting with collect and place head

Recommendation for screen printing

150µm stencil with 10% reduction of the pad size

The two outer contact lanes need to be bridged on the PCB.

Tape and reel drawing:

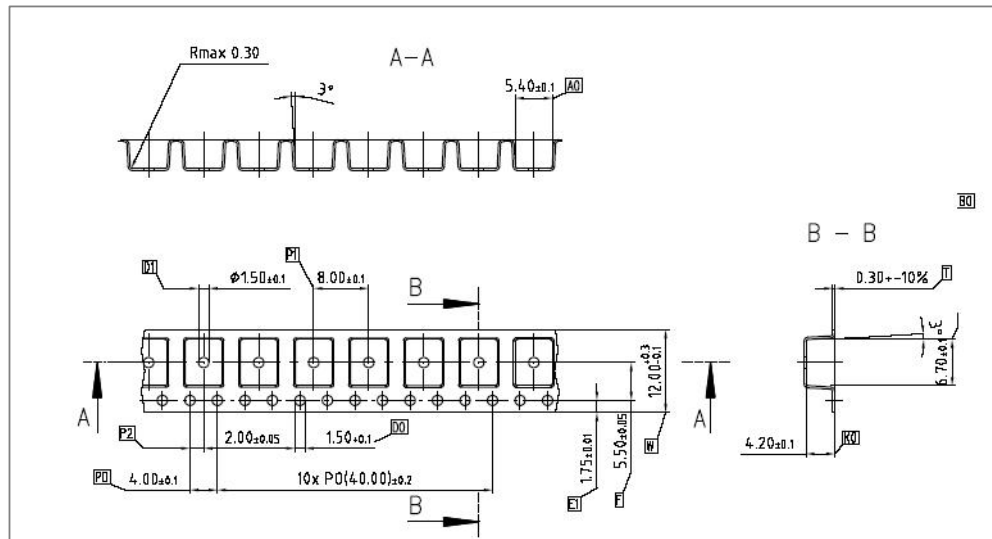

THT Version

**Dimensional drawing
THT standard version**

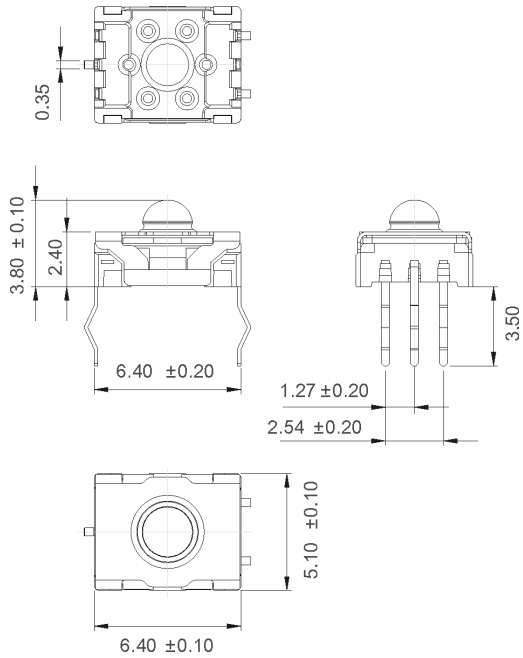

**Hole pattern
THT version**

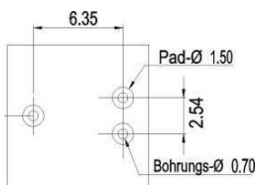

General Information

The MICON 5 plungers are aligned to the standard MICON 5 (overall height 3.85 mm). The specifications in the data sheet are only valid in combination with the usage of the standard types (THT and SMT).

Robustness max. 30 N

Non-illuminable plungers



Article-Nr.	Plunger diameter / size [mm]	Length of plunger L [mm]	Plunger colour
5.46.001.103/0200	6,0	3,0	white
5.46.001.104/0200	6,0	3,45	white
5.46.001.105/0200	6,0	3,95	white
5.46.001.106/0200	6,0	4,45	white
5.46.001.107/0200	6,0	7,15	white
5.46.001.108/0200	6,0	9,95	white
5.46.001.121/0200	8,0	5,5	white
5.46.001.122/0200	8,0	10,3	white
5.46.001.123/0200	8,0	3,0	white
5.46.001.124/0200	8,0	3,45	white
5.46.001.125/0200	8,0	3,95	white
5.46.001.126/0200	8,0	4,45	white
5.46.001.127/0200	8,0	7,15	white
5.46.001.128/0200	8,0	9,95	white
5.46.001.141/0200	11,5	5,5	white
5.46.001.142/0200	11,5	10,3	white
5.46.001.143/0200	11,5	3,0	white
5.46.001.144/0200	11,5	3,45	white
5.46.001.145/0200	11,5	3,95	white
5.46.001.146/0200	11,5	4,45	white
5.46.001.147/0200	11,5	7,15	white
5.46.001.148/0200	11,5	9,95	white
5.46.001.163/0200	14,5	3,0	white
5.46.001.164/0200	14,5	3,45	white
5.46.001.165/0200	14,5	3,95	white
5.46.001.166/0200	14,5	4,45	white
5.46.001.167/0200	14,5	7,15	white
5.46.001.168/0200	14,5	9,95	white
5.46.001.183/0200	19,0	3,0	white
5.46.001.184/0200	19,0	3,45	white
5.46.001.185/0200	19,0	3,95	white
5.46.001.186/0200	19,0	4,45	white
5.46.001.187/0200	19,0	7,15	white
5.46.001.188/0200	19,0	9,95	white

Typical system design under overlay, plunger non-illuminable, round



Recommended embossing of the overlay above the plunger area: 0.35 mm

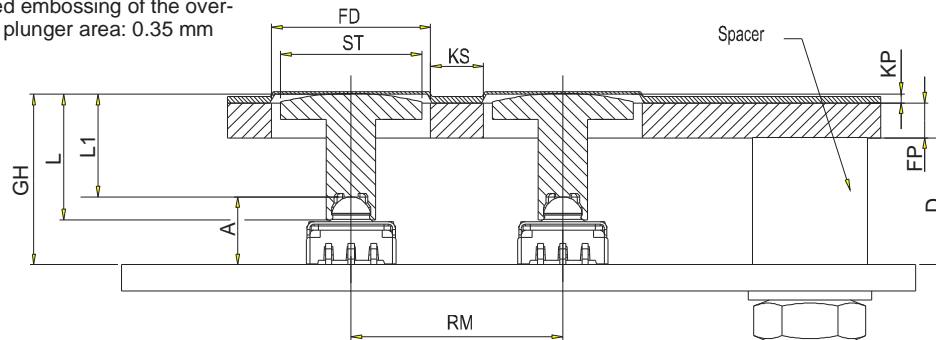

- A - Height of keyswitch: SMT type: 3.85 mm, THT type: 3.80 mm
- D - Length of spacer $D = GH - KP - FP$
- FD - Front panel cut-out $FD = ST + 1 \text{ mm}$
- FP - Front panel thickness
- GH - Overall height: $GH = A + L1 + 0.05$ (SMT type), $GH = A + L1$ (THT type)
- KP - Thickness of overlay + embossing
- KS - Glue webs for overlay, min. 3 mm
- L1 - Length of plunger above keyswitch $L1 = GH - A$
- L - Overall length of plunger $L = L1 + 1.3 \text{ mm}$ (min. 3 mm)
- RM - Key grid $RM = FD + KS$
- ST - Diameter of plunger

General Information

The MICON 5 plungers are aligned to the standard MICON 5 (overall height 3.85 mm). The specifications in the data sheet are only valid in combination with the usage of the standard types (THT and SMT).

Robustness max. 30 N

Illuminable plungers

Illuminable plunger 11 x 11 mm

Article-Nr.	Overall height GH [mm]	Lense colour
5.05.511.470/2300	9,70	red
5.05.511.470/2500	9,70	green
5.05.511.470/2400	9,70	yellow
5.05.511.470/2200	9,70	white
5.05.511.470/2600	9,70	blue
5.05.511.471/2300	12,5	red
5.05.511.471/2500	12,5	green
5.05.511.471/2400	12,5	yellow
5.05.511.471/2200	12,5	white
5.05.511.471/2600	12,5	blue



Illuminable plunger 14.5 x 14.5 mm

Article-Nr.	Overall height GH [mm]	Lense colour
5.05.511.475/2300	9,70	red
5.05.511.475/2500	9,70	green
5.05.511.475/2400	9,70	yellow
5.05.511.475/2200	9,70	white
5.05.511.475/2600	9,70	blue
5.05.511.476/2300	12,5	red
5.05.511.476/2500	12,5	green
5.05.511.476/2400	12,5	yellow
5.05.511.476/2200	12,5	white
5.05.511.476/2600	12,5	blue



Illuminable plunger 18 x 18 mm

Article-Nr.	Overall height GH [mm]	Lense colour
5.05.511.480/2300	9,70	red
5.05.511.480/2500	9,70	green
5.05.511.480/2400	9,70	yellow
5.05.511.480/2200	9,70	white
5.05.511.480/2600	9,70	blue
5.05.511.481/2300	12,5	red
5.05.511.481/2500	12,5	green
5.05.511.481/2400	12,5	yellow
5.05.511.481/2200	12,5	white
5.05.511.481/2600	12,5	blue



Typical system design under foil, plunger illuminable 11 x 11 mm

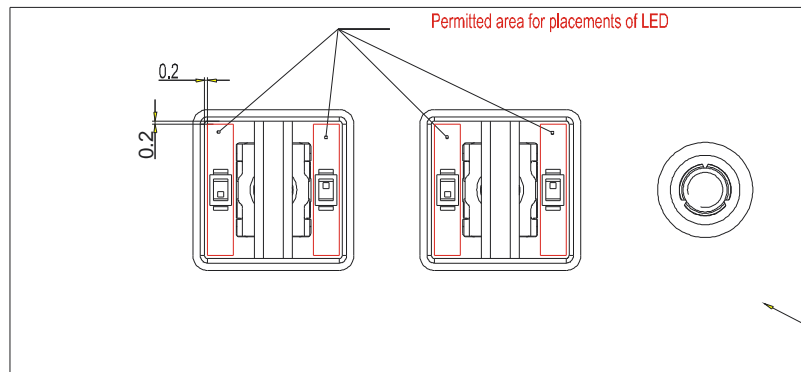
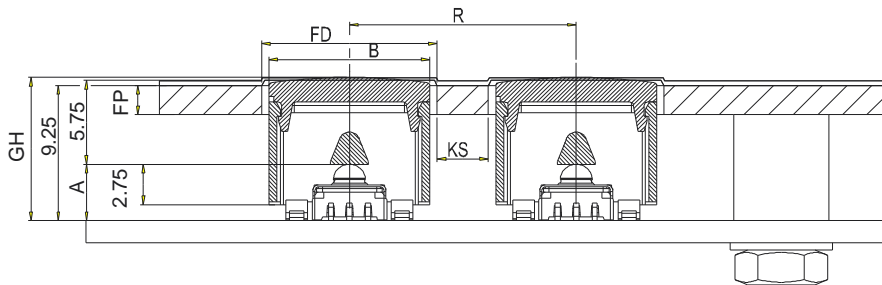
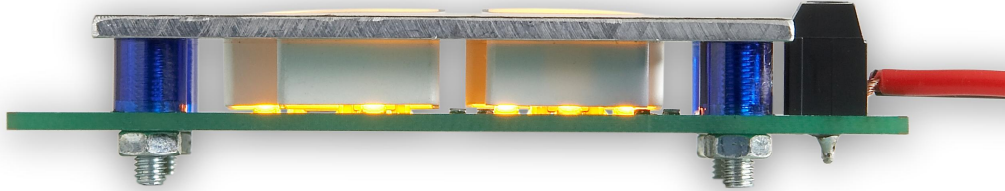

Description:

- A - Height of keyswitch:
SMT = 3.85 mm, THT = 3.80 mm
- FP - Thickness of front plate
- B - Size of plunger
- FD - Front panel cut-out: B + 1mm
- KS - Glue strip min. 3 mm
- R - Grid size: FD + KS

Drawn without front plate and lens of the actuator

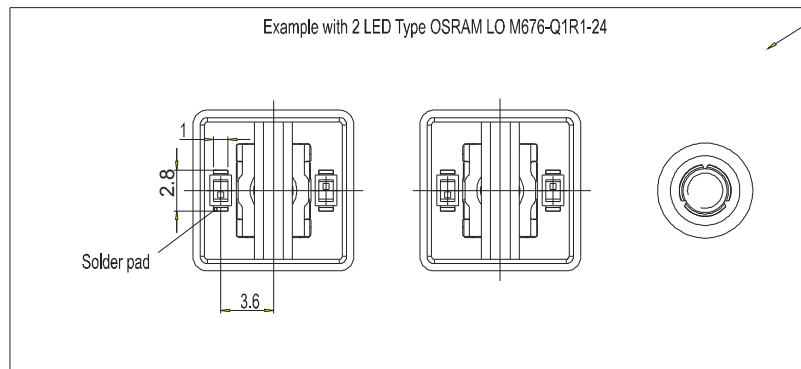

Typical system design under foil, plunger illuminable 14.5 x 14.5 mm

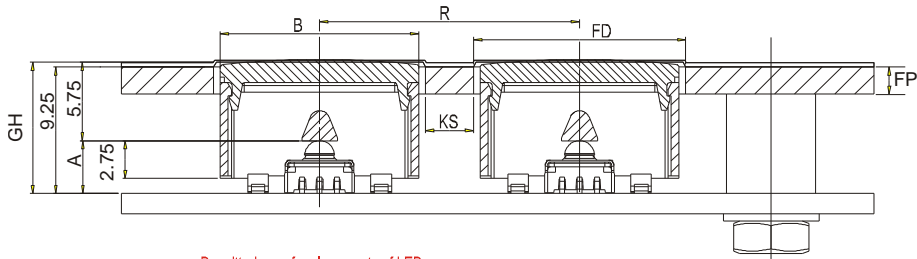

Description:

- A - Height of keyswitch
 SMT = 3.85 mm, THT = 3.80 mm
- FP - Thickness of front plate
- B - Size of plunger
- FD - Front panel cut-out: B + 1 mm
- KS - Glue strip min. 3 mm
- R - Grid size: FD + KS
- GH - Overall height: A + 5.75 mm

Permitted area for placements of LED

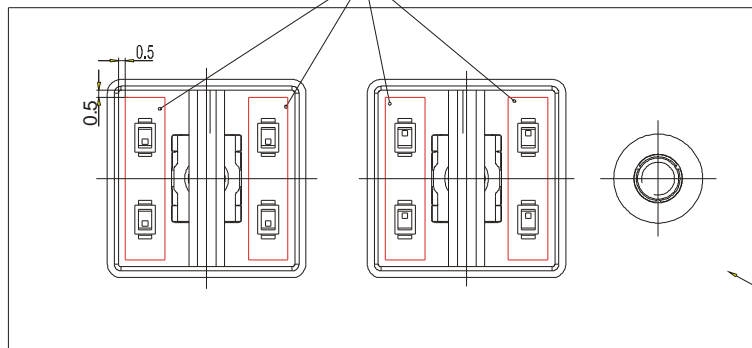

Drawn without front plate and lens of the actuator

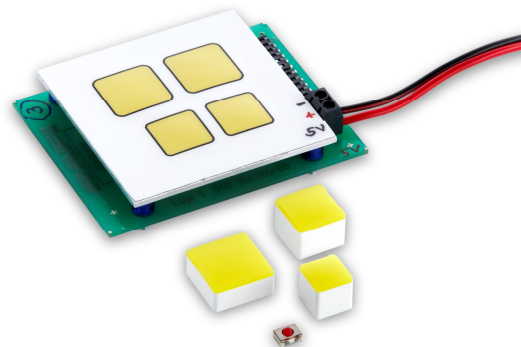
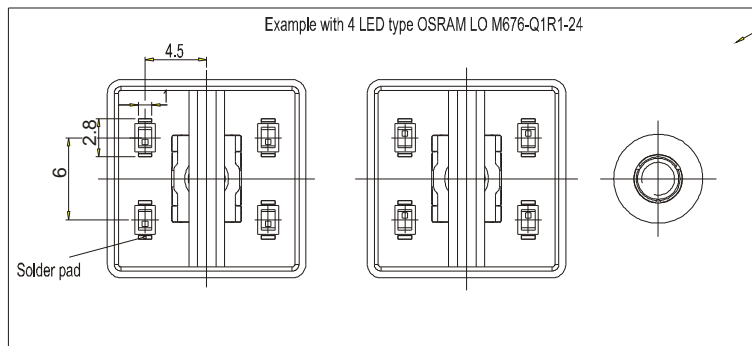

Typical system design under foil, plunger illuminable 18 x 18 mm

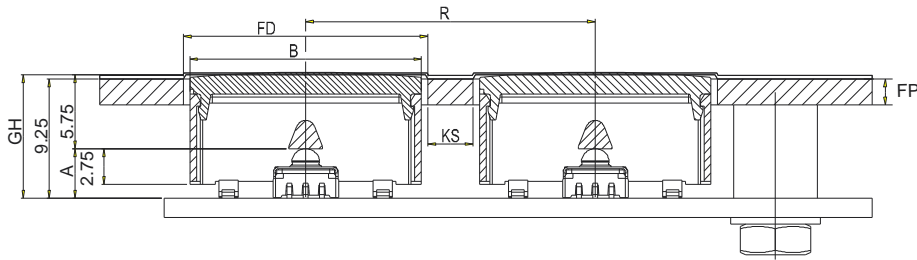

Description:

- A - Height of keyswitch
 SMT = 3.85 mm, THT = 3.80 mm
- FP - Thickness of front plate
- B - Size of plunger
- FD - Front panel cut-out: B + 1 mm
- KS - Glue strip min. 3 mm
- R - Grid size: FD + KS
- GH - Overall height: A + 5.75 mm

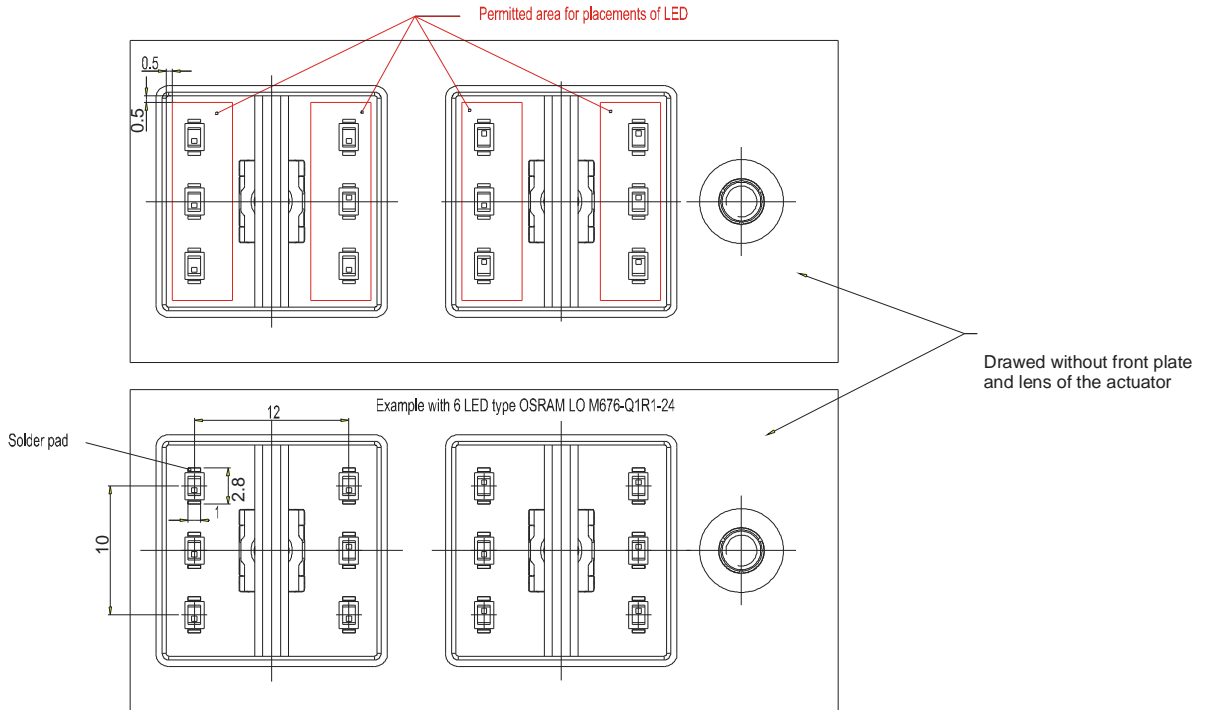

Typical system design under keycap, RK 90, 9 x 9 mm

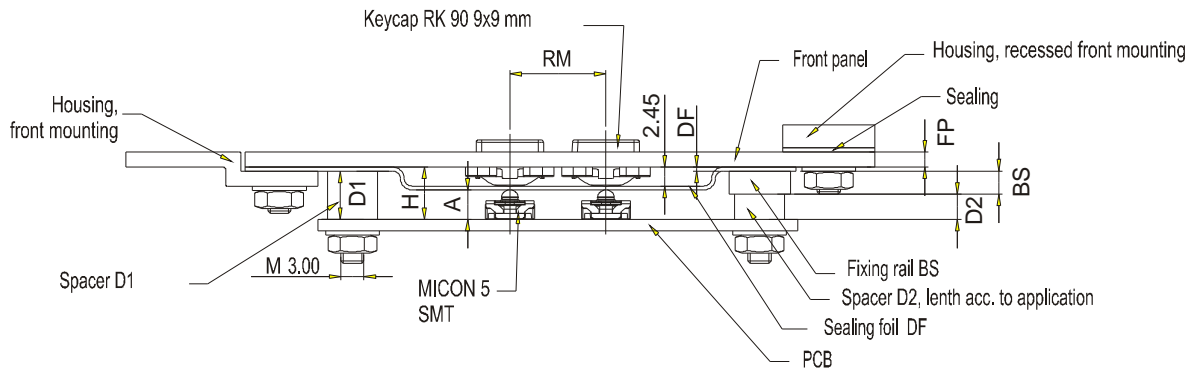
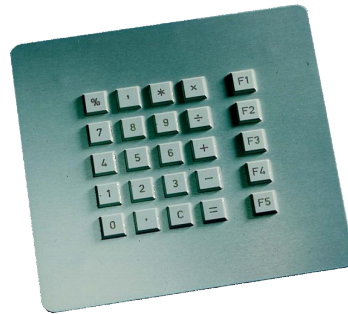

- A - Height of keyswitch: SMT: 3.85 mm, THT: 3.80 mm
- BS - Fixing rail
- D1 - Spacer D1 = H - remaining thickness of pressed sealing foil DF
- D2 - Spacer D2 = H - BS - remaining thickness of pressed sealing foil DF
- DF - Sealing foil
- FP - Front panel (1...3 mm)
- H - Distance between front pane and PCB: SMT type: 2.45 mm + A + DF + 0.05 mm, THT-type: 2.45 mm + A + DF
- RM - Key grid: the size of the keycaps determines the smallest possible key grid

Preliminary technical data, subject to technical modifications.

3 dimensional data in step or igs format on request.

RAFI GmbH & Co. KG
 Ravensburger Str. 128-134, D-88276 Berg/Ravensburg
 Tel.: +49 751 89-0, Fax: +49 751 89-1300
 www.rafi.de, info@rafi.de