

REV.	N° DCR	NATURE DE LA MODIFICATION	DATE	VISA
A	ECR-4981	Suppression reference 43 TB3 A00 FP	23/06/2010	L.B

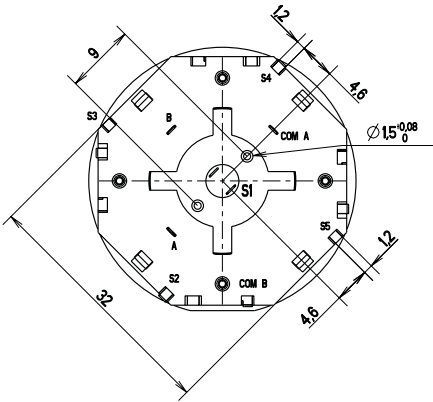

PCB LAYOUT

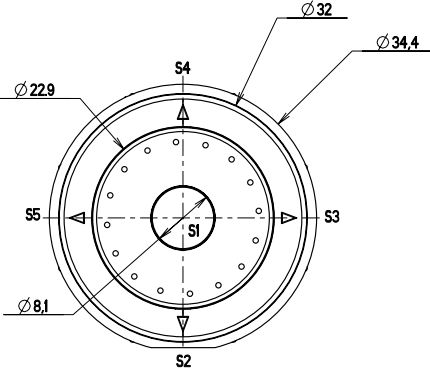
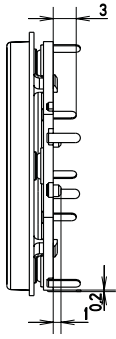

ELECTRICAL FUNCTION

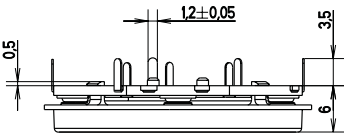
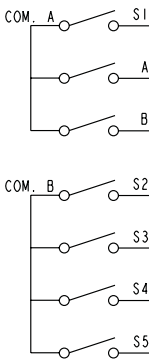

Rotational Output Waveform

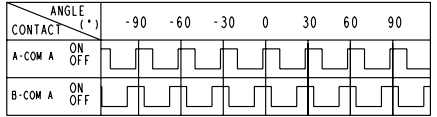

CW ← → CCW

Numbers of detent : 24  
Pulse/Rotation : 12 pulse/360°

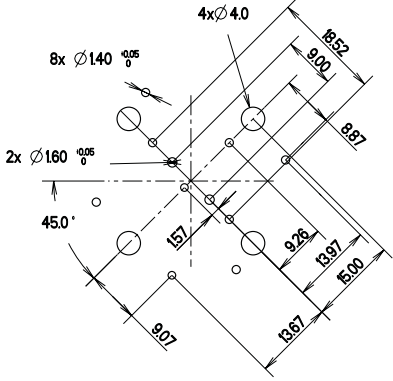

Reference	Designation
43 TB3 C00 FP	TSW B-3N-C LFS

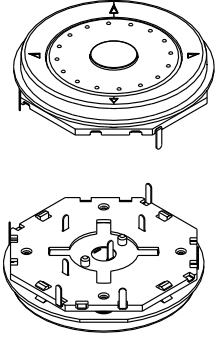

MATERIAL / VOLUME	TREATMENT	PROTECTION
UNLESS OTHERWISE : - DIMENSIONS GIVEN BEFORE PROTECTION - BURRS AND SHARP EDGES DELETED	LINEAR TOLERANCE ± 0.4 ANGULAR TOLERANCE ± 1 ° SURFACE FINISH Ra	CRITICAL DIMENSIONS 0 SPC DIMENSIONS 0
CREATE BY JUPILLE P DATE 07/09/09	DATE 07/09/09	MODIFICATION see revision table on the first sheet
CHECKED BY KUBAT L	DATE	REPLACE
APPROVED BY Laurent Kubat DATE 2010.06.24 08:51:19+02'00'	DATE 2010.06.24 08:51:19+02'00'	FILENAME 43MTB00FP.XPLUJE FOLDER Dossier racine/dole.south.rd/zippy/bouton/produit
PART DESCRIPTION		
Tact and Scroll Wheel TYPE B		
G&K C&K Components		SCALE 2,000
SIZE A3	SHEET 1 / 1	PART NUMBER CU 43 MTB 001 FP REV A
BP 359 - 39105 Dole - FRANCE -		

CE PLAN ET LA PROPRETE DE C&K COMPONENTS SONT A ETRE REPRODUIT OU COMMUNIQUE SANS SON AUTORISATION