

REED SWITCH

ORD2211

Lamp Load

■ GENERAL DESCRIPTION

The ORD2211 is a single-contact reed switch designed for direct opening or closing lamps of 12 V - 3.4 W. The contacts are sealed within the glass tube with inert gas to maintain contact reliability.

■ FEATURES

- (1) Reed contacts are hermetically sealed within a glass tube with inert gas and do not receive any influence from the external atmospheric environment.
- (2) Quick response
- (3) The structure comprises the operating parts and electrical circuits arranged coaxially. Reed switches are suited to applications in radio frequency operation.
- (4) Reed switches are compact and light weight.
- (5) Superior corrosion resistance and wear resistance of the contacts assures stable switching operation and long life.
- (6) With a permanent magnet installed, reed switches economically and easily become proximity switches.

3

■ EXTERNAL DIMENSIONS (Unit: mm)

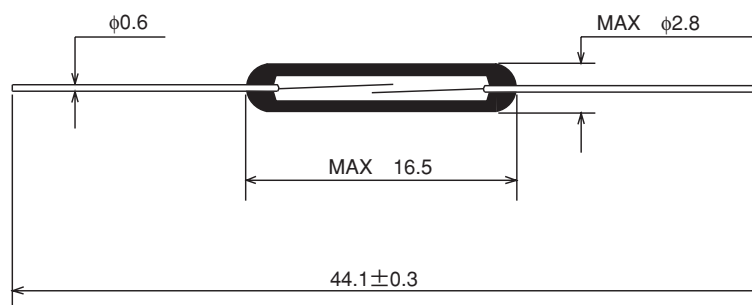

■ APPLICATIONS

- Automotive electronic devices
- Control equipment
- Communication equipment
- Measurement equipment
- Household appliances

■ ELECTRICAL CHARACTERISTICS

Parameter	Rated value	Unit
Pull-in Value (PI)	20~60	AT
Drop-out Value (DO)	8min	AT
Contact resistance (CR)	100max	mΩ
Breakdown voltage	200min (PI ≥ 20)	VDC
Insulation resistance	10 ⁹ min	Ω
Electrostatic capacitance	0.3max	pF
Contact rating	50 (12V-3.4W lamp)	VA
Maximum switching voltage	100 $\begin{matrix} \text{DC} \\ \text{AC} \end{matrix}$	V
Maximum switching current	0.5 (Inrush 3A)	A
Maximum carry current	2.5	A

3

(1) Drop-out Value vs. Pull-in Value

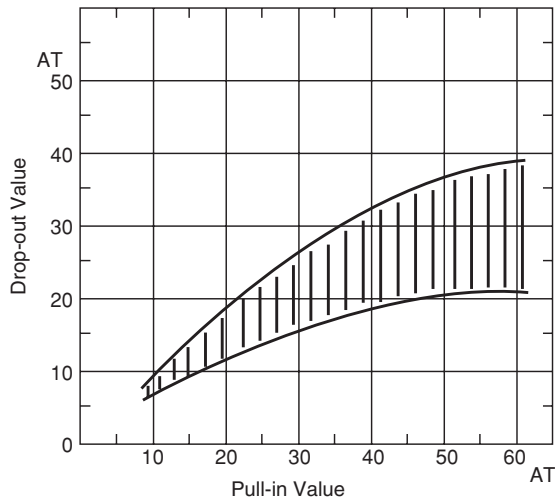

(2) Contact resistance

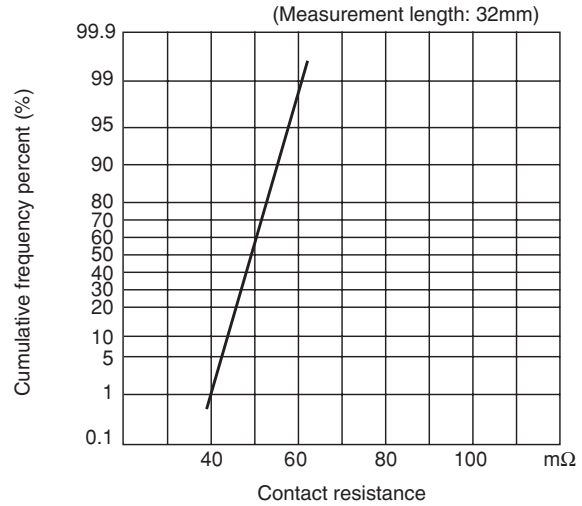

(3) Breakdown voltage

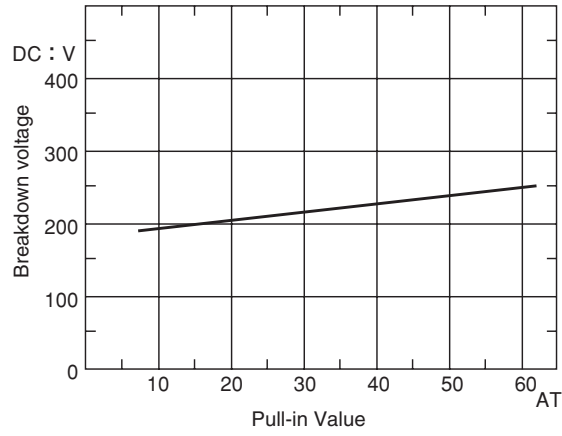

(4) Insulation resistance

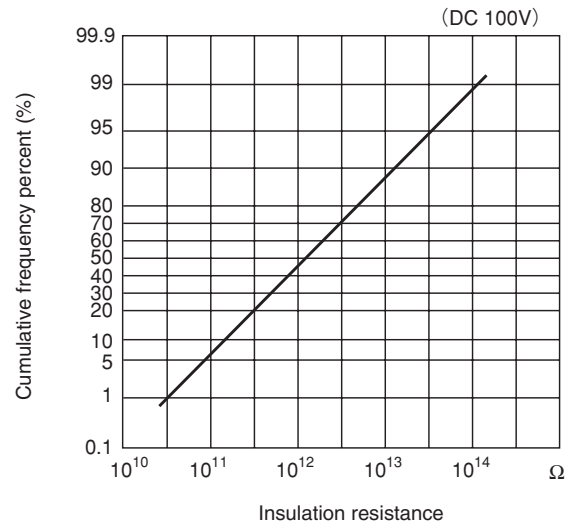

3

(5) Electrostatic capacitance

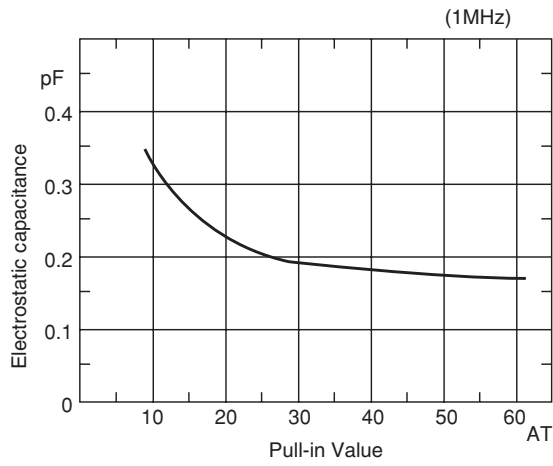

■ OPERATING CHARACTERISTICS

Parameter	Rated value	Unit
Operate time	0.6max	ms
Bounce time	0.4max	ms
Release time	0.05max	ms
Resonant frequency	4600±500	Hz
Maximum operating frequency	500	Hz

3

(1) Operate time

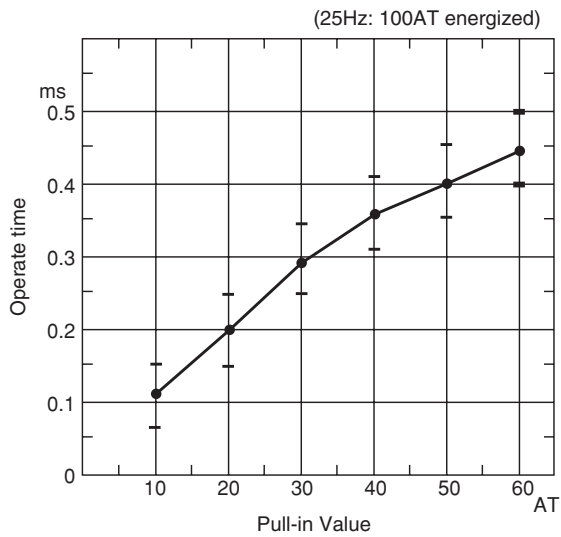

(2) Bounce time

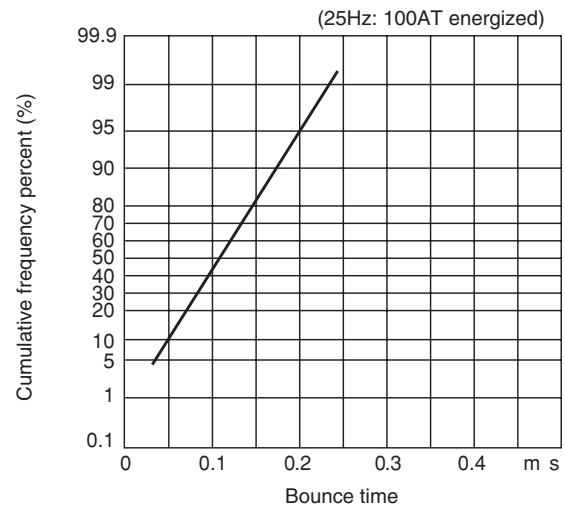

(3) Release time

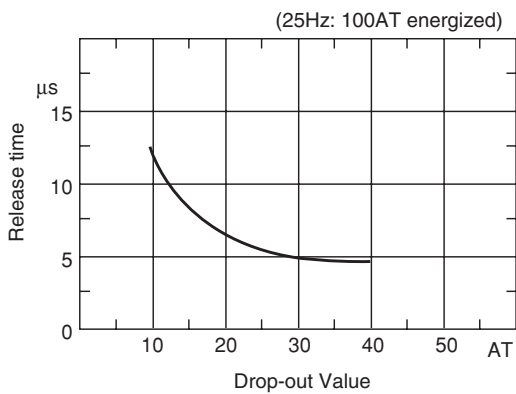

(4) Resonant frequency

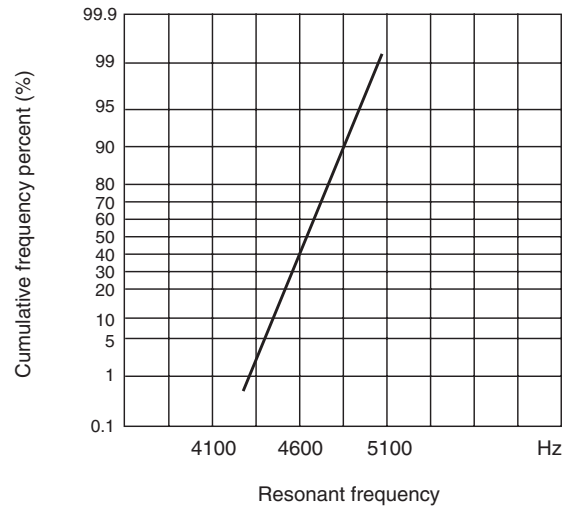

■ MECHANICAL CHARACTERISTICS

(1) Lead tensile test (static load)

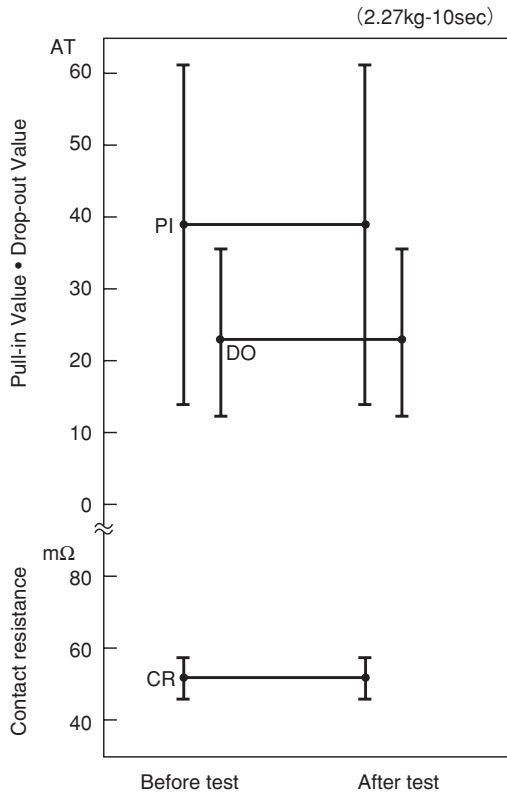

(2) Lead tensile strength

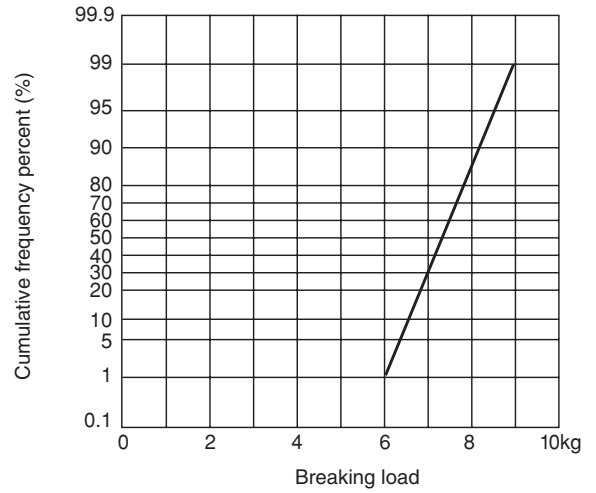

3

■ ENVIRONMENTAL CHARACTERISTICS

(1) Temperature characteristics

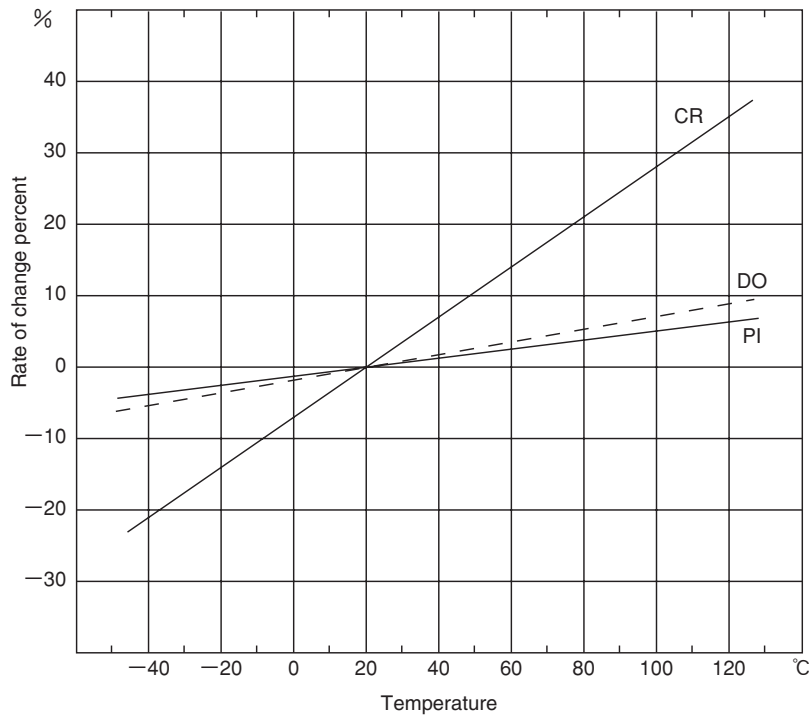

3

(2) Temperature cycle

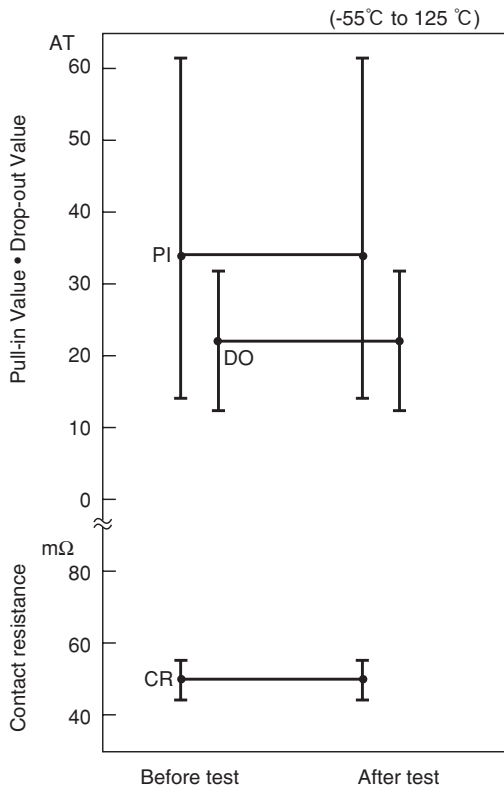

(3) Temperature and humidity cycle

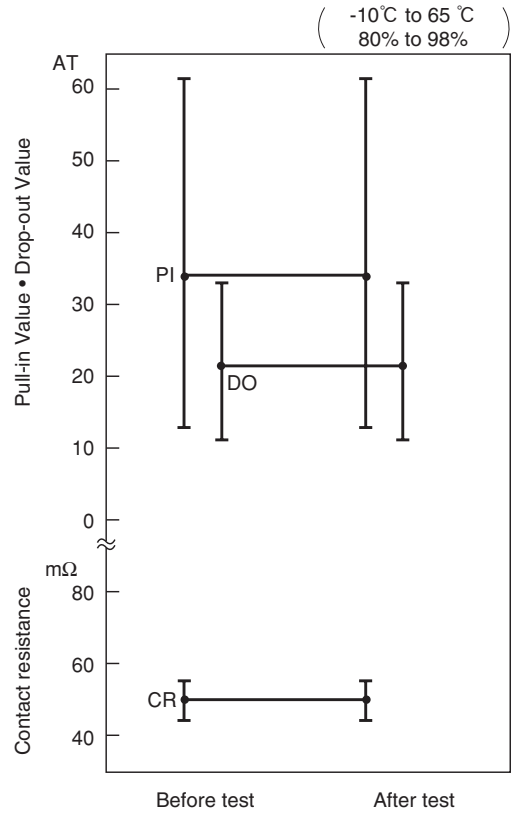

(4) High temperature storage test

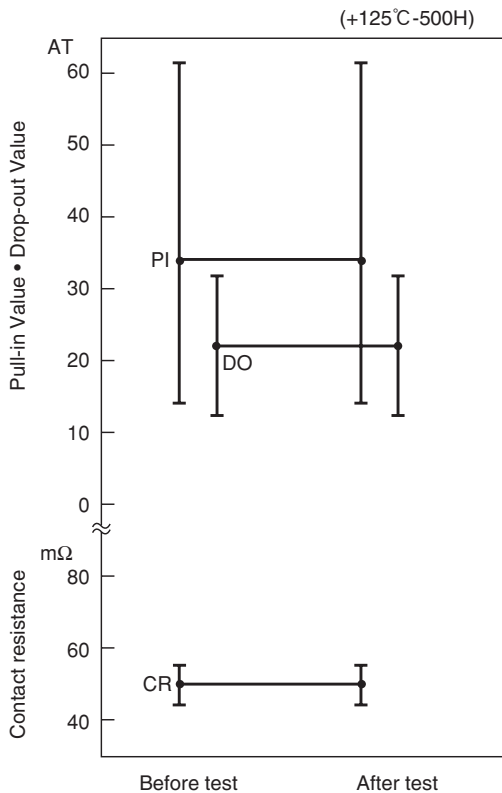

(5) Low temperature storage test

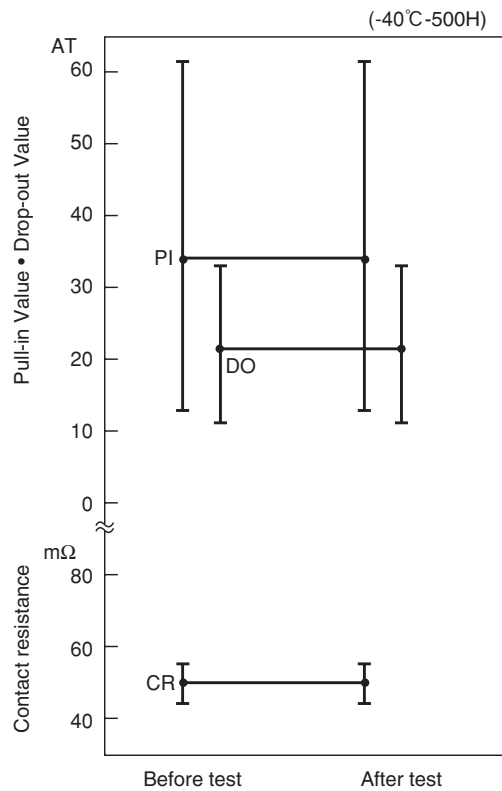

(6) Shock test

1) Electrical characteristics

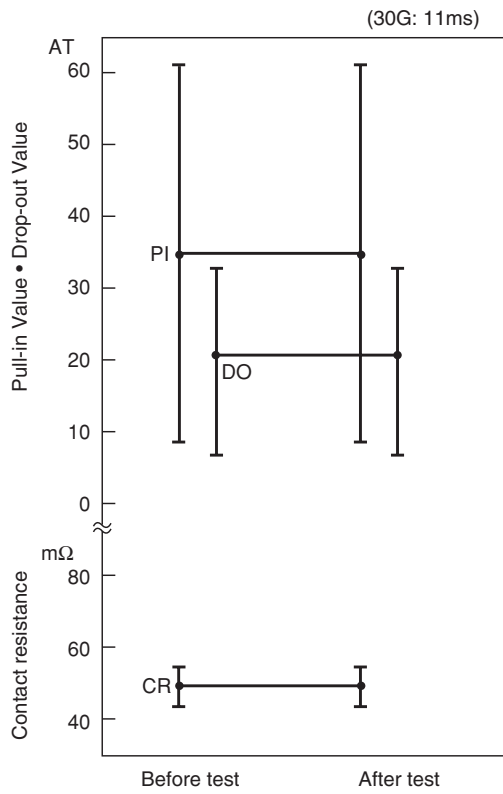

2) Misoperation area

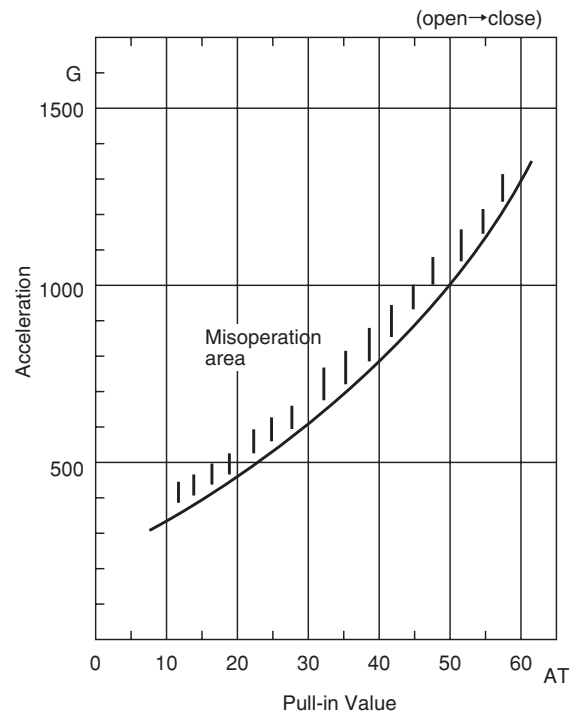

3

(7) Vibration test

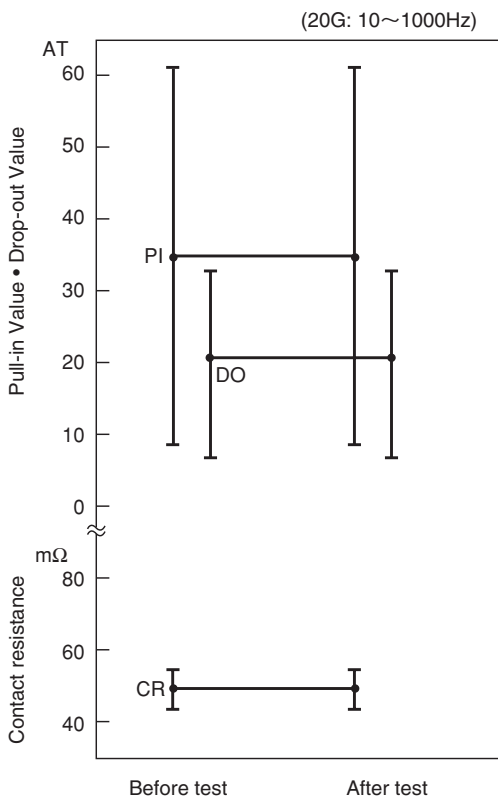

■ LIFE EXPECTANCY DATA: ORD2211

Load conditions
 Voltage: 13, 14, 16 : VDC
 Current: 12V-3.4W Lamp

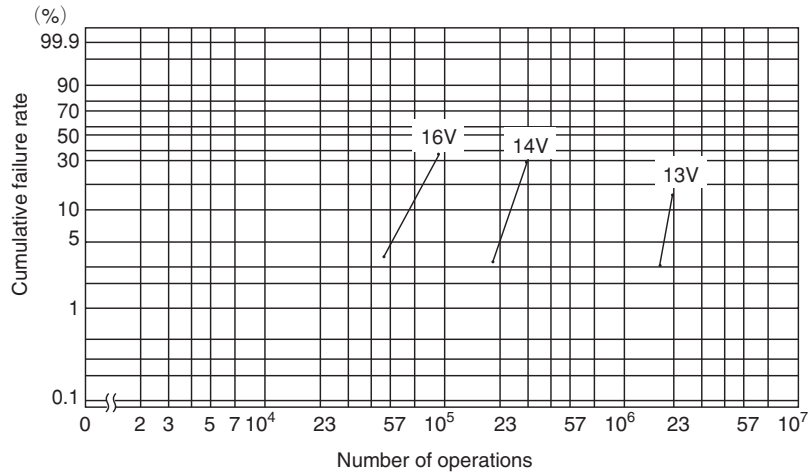

3

Load conditions
 Voltage: 50VDC
 Current: 1A
 Load: Resistive load

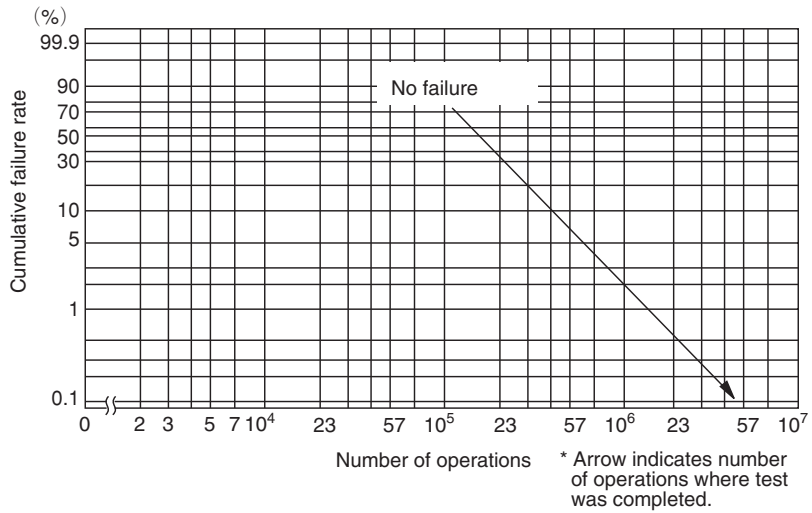

Load conditions
 Voltage: 6VDC
 Current: 10mA, 50mA
 Load: Resistive load

