

Converter - Brake - Inverter Module

NPT IGBT

Single Phase Rectifier	Three Phase Inverter
$V_{RRM} = 1600 \text{ V}$	$V_{CES} = 600 \text{ V}$
$I_{DAVM25} = 90 \text{ A}$	$I_{C25} = 18 \text{ A}$
$I_{FSM} = 270 \text{ A}$	$V_{CE(sat)} = 2.1 \text{ V}$

Part name (Marking on product)

MIAA10WF600TMH

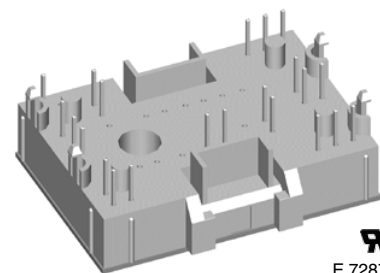
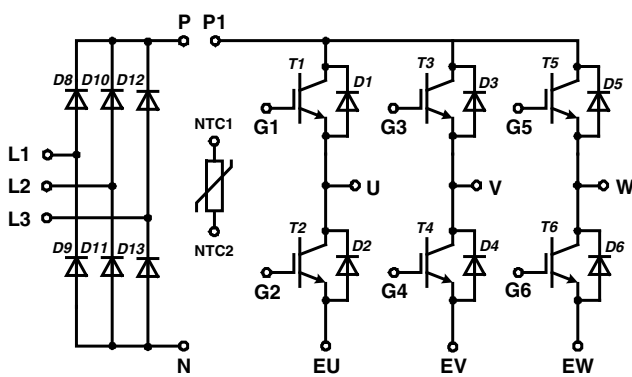

Pin configuration see outlines.

Features:

- High level of integration - only one power semiconductor module required for the whole drive
- Inverter with NPT IGBTs
 - low saturation voltage
 - positive temperature coefficient
 - fast switching
 - short tail current
- Epitaxial free wheeling diodes with hiperfast soft reverse recovery
- Temperature sense included

Application:

- AC motor drives
- Pumps, Fans
- Washing machines
- Air-conditioning system
- Inverter and power supplies

Package:

- "Mini" package
- Assembly height is 17 mm
- Insulated base plate
- Pins suitable for wave soldering and PCB mounting
- Assembly clips available
 - IXKU 5-505 screw clamp
 - IXRB 5-506 click clamp
- UL registered E72873

Output Inverter T1 - T6

Symbol	Definitions	Conditions	Ratings			Unit	
			min.	typ.	max.		
V_{CES}	collector emitter voltage				600	V	
V_{GES}	max. DC gate voltage	continuous			±20	V	
V_{GEM}	max. transient collector gate voltage	transient			±30	V	
I_{C25}	collector current		$T_C = 25^\circ\text{C}$		18	A	
I_{C80}			$T_C = 80^\circ\text{C}$		13	A	
P_{tot}	total power dissipation		$T_C = 25^\circ\text{C}$		70	W	
$V_{CE(sat)}$	collector emitter saturation voltage	$I_C = 10\text{ A}; V_{GE} = 15\text{ V}$	$T_{VJ} = 25^\circ\text{C}$ $T_{VJ} = 125^\circ\text{C}$	2.1 2.3	2.6	V V	
$V_{GE(th)}$	gate emitter threshold voltage	$I_C = 0.35\text{ A}; V_{GE} = V_{CE}$	$T_{VJ} = 25^\circ\text{C}$	4.5	5.5	6.5	V
I_{CES}	collector emitter leakage current	$V_{CE} = V_{CES}; V_{GE} = 0\text{ V}$	$T_{VJ} = 25^\circ\text{C}$ $T_{VJ} = 125^\circ\text{C}$		0.6	mA mA	
I_{GES}	gate emitter leakage current	$V_{GE} = \pm 20\text{ V}$			150	nA	
C_{ies}	input capacitance	$V_{CE} = 25\text{ V}; V_{GE} = 0\text{ V}; f = 1\text{ MHz}$		450		pF	
$Q_{G(on)}$	total gate charge	$V_{CE} = 300\text{ V}; V_{GE} = 15\text{ V}; I_C = 10\text{ A}$		50		nC	
$t_{d(on)}$	turn-on delay time	inductive load $V_{CE} = 300\text{ V}; I_C = 10\text{ A}$ $V_{GE} = \pm 15\text{ V}; R_G = 82\ \Omega$	$T_{VJ} = 25^\circ\text{C}$		32	ns	
t_r	current rise time				35	ns	
$t_{d(off)}$	turn-off delay time				180	ns	
t_f	current fall time				110	ns	
E_{on}	turn-on energy per pulse				0.17	mJ	
E_{off}	turn-off energy per pulse				0.2	mJ	
$t_{d(on)}$	turn-on delay time	inductive load $V_{CE} = 300\text{ V}; I_C = 10\text{ A}$ $V_{GE} = \pm 15\text{ V}; R_G = 82\ \Omega$	$T_{VJ} = 125^\circ\text{C}$		32	ns	
t_r	current rise time				35	ns	
$t_{d(off)}$	turn-off delay time				190	ns	
t_f	current fall time				170	ns	
E_{on}	turn-on energy per pulse				0.27	mJ	
E_{off}	turn-off energy per pulse				0.42	mJ	
RBSOA	reverse bias safe operating area	$V_{GE} = \pm 15\text{ V}; R_G = 82\ \Omega; I_C = 20\text{ A}$	$T_{VJ} = 125^\circ\text{C}$	$V_{CEK} \leq V_{CES} - L_S \cdot di/dt$		V	
I_{SC} (SCSOA)	short circuit safe operating area	$V_{CE} = 360\text{ V}; V_{GE} = \pm 15\text{ V};$ $R_G = 82\ \Omega; t_p = 10\ \mu\text{s};$ non-repetitive	$T_{VJ} = 125^\circ\text{C}$	40		A	
R_{thJC}	thermal resistance junction to case	(per IGBT)			1.8	K/W	
R_{thCH}	thermal resistance case to heatsink			0.6		K/W	

Output Inverter D1 - D6

Symbol	Definitions	Conditions	Ratings			Unit
			min.	typ.	max.	
V_{RRM}	max. repetitive reverse voltage		$T_{VJ} = 150^\circ\text{C}$		600	V
I_{F25}	forward current		$T_C = 25^\circ\text{C}$		22	A
I_{F80}			$T_C = 80^\circ\text{C}$		14	A
V_F	forward voltage	$I_F = 10\text{ A}; V_{GE} = 0\text{ V}$	$T_{VJ} = 25^\circ\text{C}$ $T_{VJ} = 125^\circ\text{C}$	1.7 1.4	2.2	V V
Q_{rr}	reverse recovery charge	$V_R = 300\text{ V}$ $di_F/dt = -300\text{ A}/\mu\text{s}$ $I_F = 10\text{ A}; V_{GE} = 0\text{ V}$	$T_{VJ} = 125^\circ\text{C}$		0.3	μC
I_{RM}	max. reverse recovery current				8.8	A
t_{rr}	reverse recovery time				95	ns
E_{rec}	reverse recovery energy				22	μJ
R_{thJC}	thermal resistance junction to case	(per diode)			2.5	K/W
R_{thCH}	thermal resistance case to heatsink			0.85		K/W

 $T_C = 25^\circ\text{C}$ unless otherwise stated

IXYS reserves the right to change limits, test conditions and dimensions.

20070404a

Input Rectifier Bridge D8 - D11

Symbol	Definitions	Conditions	Ratings			Unit
			min.	typ.	max.	
V_{RRM}	max. repetitive reverse voltage		$T_{VJ} = 25^{\circ}\text{C}$		1600	V
I_{FAV}	average forward current	sine 180°	$T_C = 80^{\circ}\text{C}$		22	A
I_{DAVM}	max. average DC output current	rect.; $d = 1/3$	$T_C = 80^{\circ}\text{C}$		62	A
I_{FSM}	max. forward surge current	$t = 10\text{ ms}$; sine 50 Hz	$T_{VJ} = 25^{\circ}\text{C}$ $T_{VJ} = 125^{\circ}\text{C}$		270 tbd	A A
I^2t	I^2t value for fusing	$t = 10\text{ ms}$; sine 50 Hz	$T_{VJ} = 25^{\circ}\text{C}$ $T_{VJ} = 125^{\circ}\text{C}$		365 tbd	A ² s A ² s
P_{tot}	total power dissipation		$T_C = 25^{\circ}\text{C}$		50	W
V_F	forward voltage	$I_F = 30\text{ A}$	$T_{VJ} = 25^{\circ}\text{C}$ $T_{VJ} = 125^{\circ}\text{C}$	1.35 1.35	1.6	V V
I_R	reverse current	$V_R = V_{RRM}$	$T_{VJ} = 25^{\circ}\text{C}$ $T_{VJ} = 125^{\circ}\text{C}$	0.3	0.01	mA mA
R_{thJC}	thermal resistance junction to case	(per diode)			2.1	K/W
R_{thCH}	thermal resistance case to heatsink	(per diode)		0.7		K/W

Temperature Sensor NTC

Symbol	Definitions	Conditions	Ratings			Unit	
			min.	typ.	max.		
R_{25}	resistance		$T_C = 25^{\circ}\text{C}$	4.75	5.0	5.25	k Ω
$B_{25/50}$					3375		K

Module

Symbol	Definitions	Conditions	Ratings			Unit
			min.	typ.	max.	
T_{VJ}	operating temperature		-40		125	$^{\circ}\text{C}$
T_{VJM}	max. virtual junction temperature				150	$^{\circ}\text{C}$
T_{stg}	storage temperature		-40		125	$^{\circ}\text{C}$
V_{ISOL}	isolation voltage	$I_{ISOL} \leq 1\text{ mA}$; 50/60 Hz			2500	V~
CTI	comparative tracking index				-	
F_C	mounting force		40		80	N
d_S	creep distance on surface		12.7			mm
d_A	strike distance through air		12			mm
Weight				35		g

Equivalent Circuits for Simulation

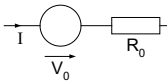

Symbol	Definitions	Conditions	Ratings			Unit
			min.	typ.	max.	
V_0	rectifier diode	D8 - D11	$T_{VJ} = 125^{\circ}\text{C}$	0.9		V
R_0				16		m Ω
V_0	IGBT	T1 - T6	$T_{VJ} = 125^{\circ}\text{C}$	1.0		V
R_0				125		m Ω
V_0	free wheeling diode	D1 - D6	$T_{VJ} = 125^{\circ}\text{C}$	1.05		V
R_0				35		m Ω

$T_C = 25^{\circ}\text{C}$ unless otherwise stated

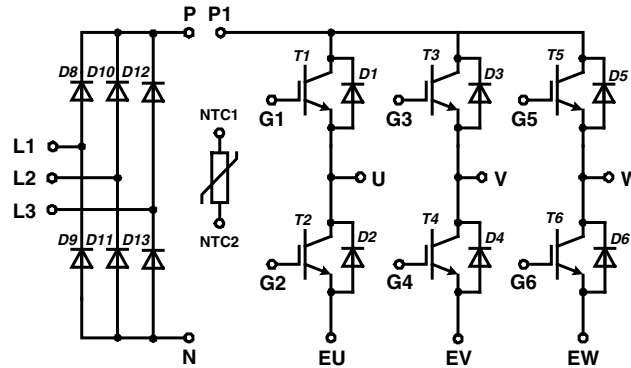
Circuit Diagram

Outline Drawing

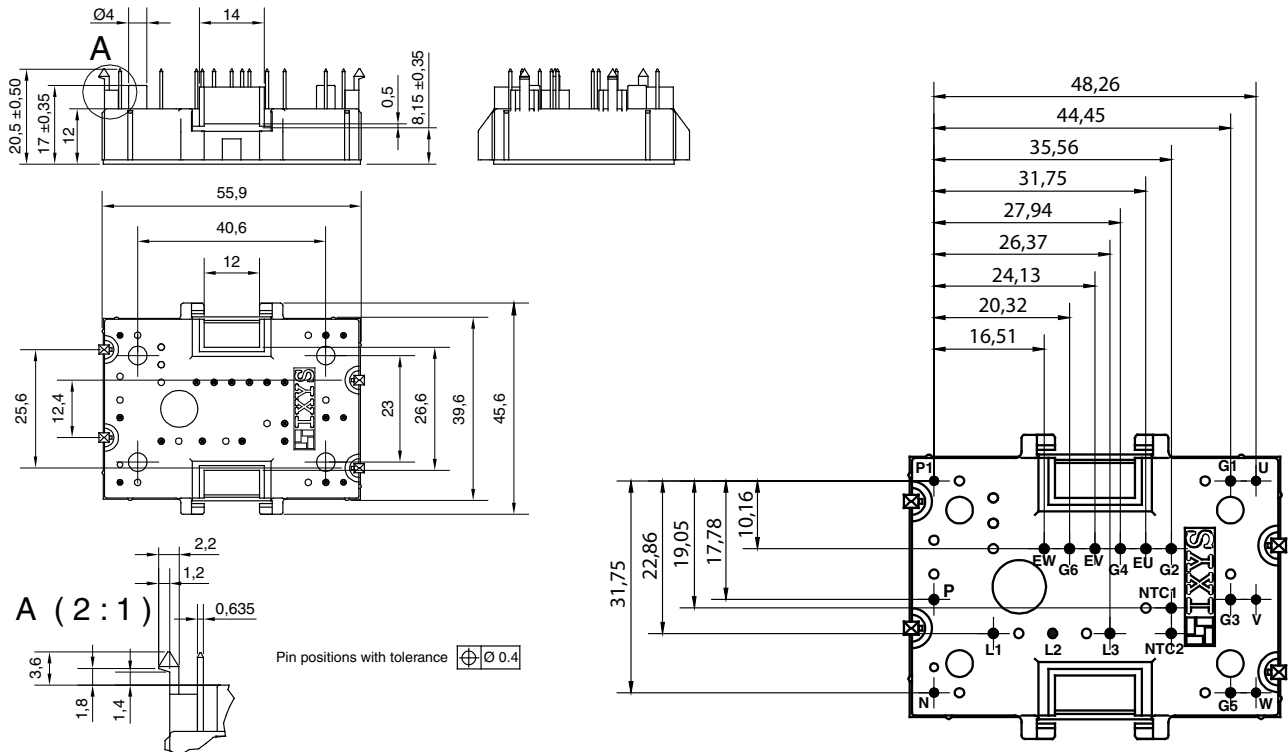
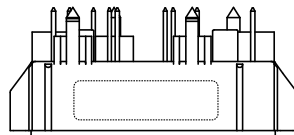
Dimensions in mm (1 mm = 0.0394")

Product Marking

Part number

M = Module
 I = IGBT
 A = IGBT (NPT)
 A = Gen 1 / std
 10 = Current Rating [A]
 WF = 6-Pack + 3~ Rectifier Bridge
 600 = Reverse Voltage [V]
 T = NTC
 MH = MiniPack2

Ordering	Part Name	Marking on Product	Delivering Mode	Base Qty	Ordering Code
Standard	MIAA 10 WF 600 TMH	MIAA10WF600TMH	Box	20	504694

IXYS reserves the right to change limits, test conditions and dimensions.

20070404a

© 2007 IXYS All rights reserved

4 - 7

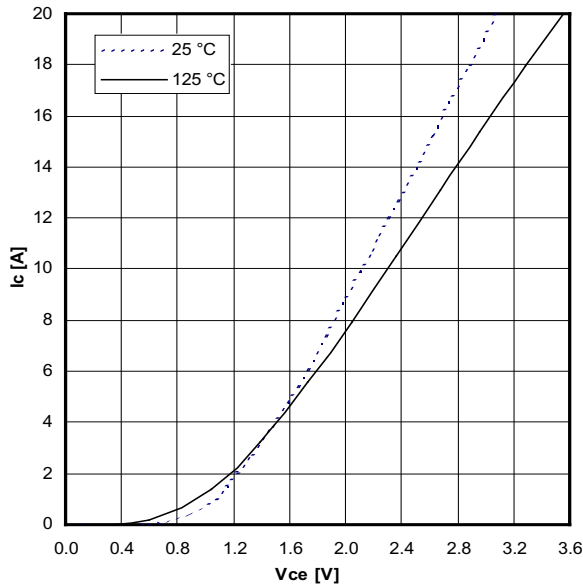
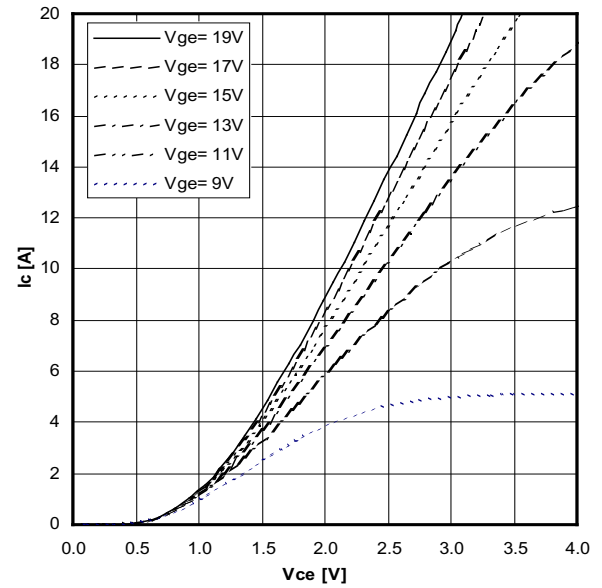
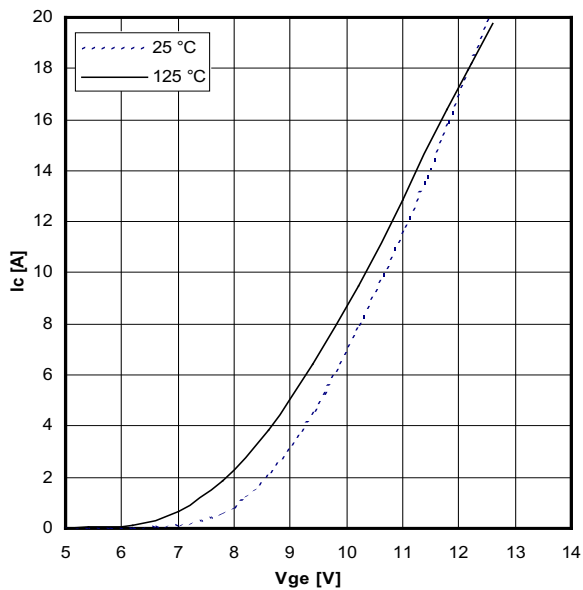
 Typical output characteristics, $V_{GE} = 15\text{ V}$

 Typical output characteristics ($125\text{ }^\circ\text{C}$)

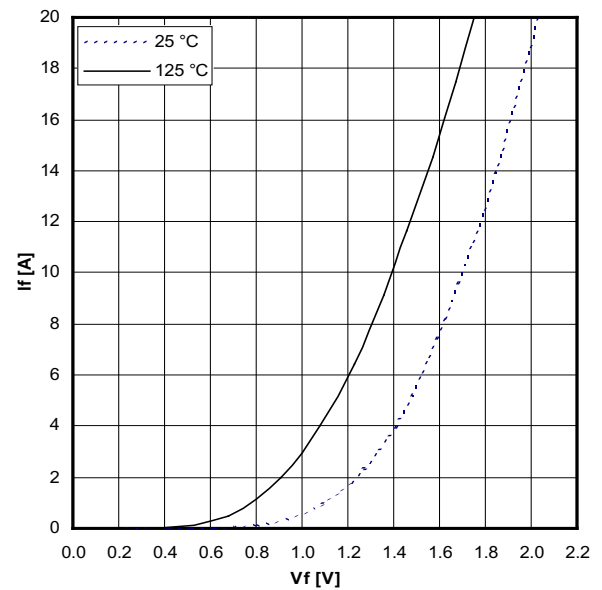
Typical transfer characteristics

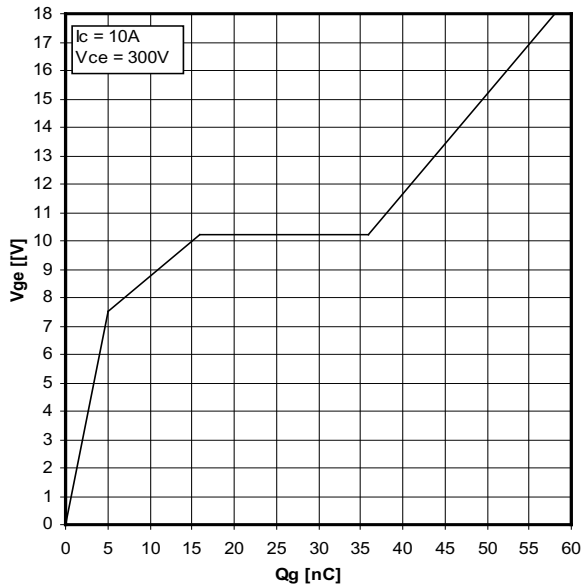

Typical forward characteristics of freewheeling diode



Typical turn on gate charge

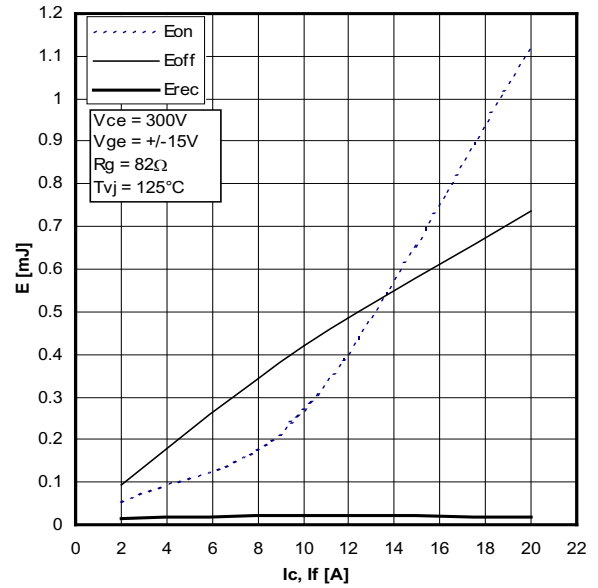

Typical switching energy versus collector current

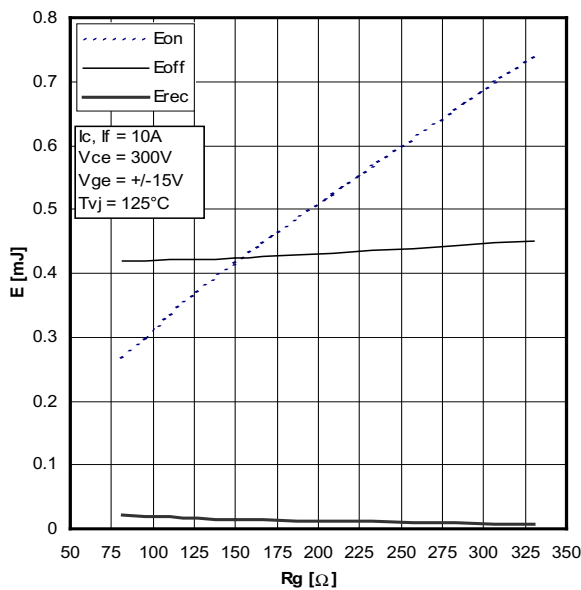

Typical switching energy versus gate resistance

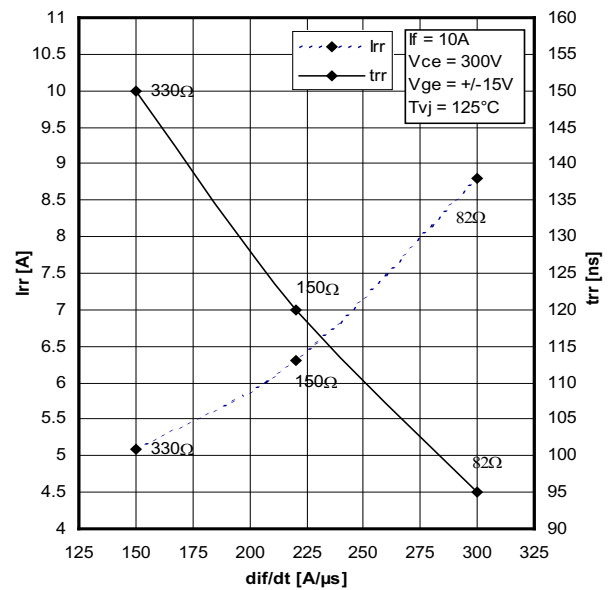

Typical turn-off characteristics of free wheeling diode

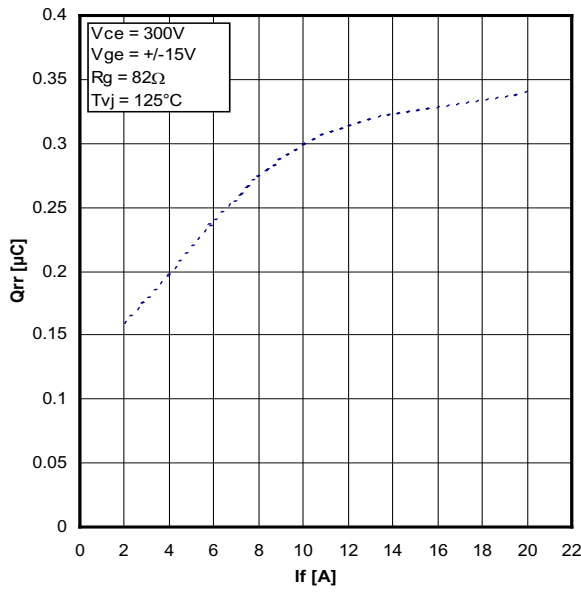

Typical turn-off characteristics of free wheeling diode

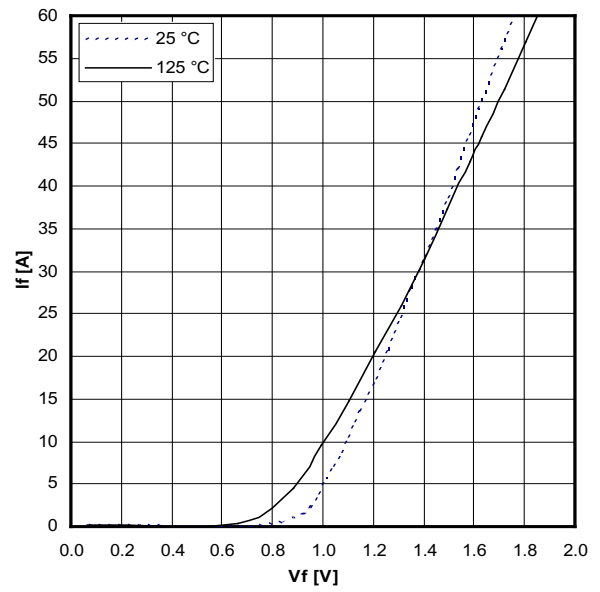

Typical forward characteristics per rectifier

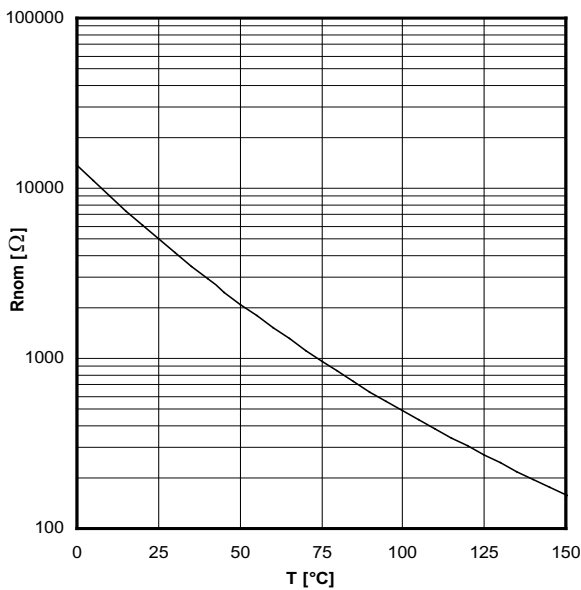

Typical thermistor resistance versus temperature