

SERIES 90HB
SPST, Low Profile

FEATURES

- Compatible with SMT Assembly, Including Infrared Reflow and Vapor-Phase
- Top Seal Withstands High Pressure Aqueous Cleaning
- Reliable Spring and Ball Contact

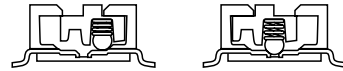

DIMENSIONS In inches (and millimeters)

Top View—Gull Wing

SWITCH IS PACKAGED AS SHOWN HERE WITH ALL POSITIONS ON

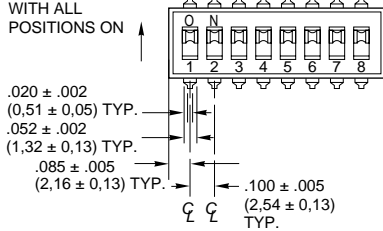

Recommended PC Pad Dimensions—Gull Wing

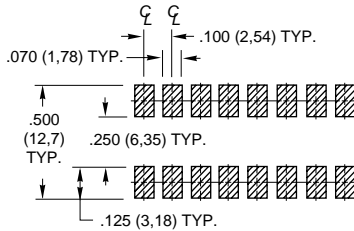

Recommended PC Pad Dimensions—J-Bend

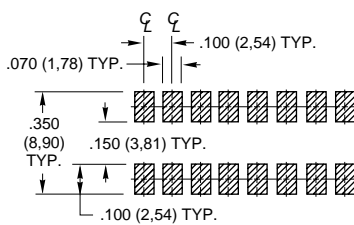

Gull Wing

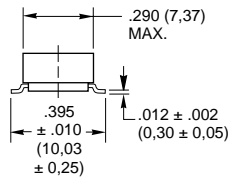

J-Bend

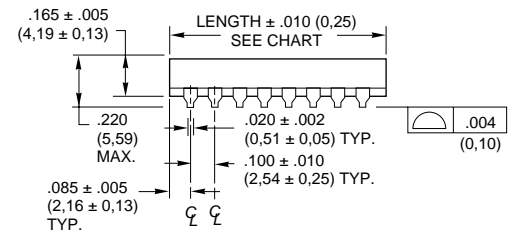
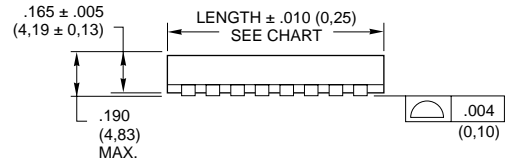
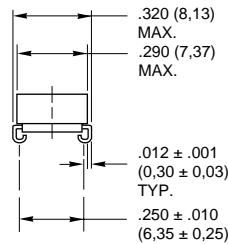

CIRCUITRY

As viewed from the top of the switch in the positions shown in the drawing.

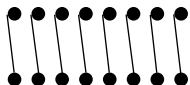

SPECIFICATIONS

Electrical Ratings

Make-and-break Current Rating: 2,000 operations per switch position at these resistive loads: 10 mA, 30 Vdc; or 10 mA, 50 mVdc; 10 mA, 50 mVdc; or 25 mA, 24 Vdc; or 100 mA, 6 Vdc.

Contact Resistance: (measured at 10 mA, 50 mVdc). Initial: 20 mohms maximum, After Life: 100 mohms maximum

Insulation Resistance: Minimum, at 100 Vdc between adjacent closed contacts and also across open switch contacts.

Initial (Mohms): 5,000, After Life (Mohms): 1,000
Dielectric Strength: Minimum voltage (AC RMS) measured between adjacent closed contacts and also across open switch contacts.

Initial: 500 volts, After Life: 500 volts

Current Carry Rating: 3A maximum rise of 20°C

Switch Capacitance: 2 pF at 1 megahertz

Mechanical Ratings

Where Grayhill performance is superior, the MIL spec is listed in parentheses.

Mechanical Life: 5,000 operations per switch position

Vibration Resistance: Per Method 204, Test Condition B, 1mS opening (10 mS allowed)

Mechanical Shock: Per Method 213, Test Condition A. 1mS opening (10 mS allowed)

Thermal Shock Resistance: Per specification; no failures; passes contact resistance.

Terminal Strength: Per specification

Thermal Aging: 1,000 hours at 85°C; no failures.

Environmental Ratings

Meets all requirements of MIL-S-83504.

Operating Temperature Range: -40°C to +85°C

Storage Temperature Range: -40°C to +85°C

Moisture Resistance: Per specification, Method 106.

Soldering Information

Solderability: Per MIL-STD-202, Method 208

Soldering Heat Resistance: Per MIL-S-83504, six second test.

Recommended Processing Temperature: 220°C–230°C (1 pass—260°C maximum)

Processing Position: Switch is to be processed with all actuators in the closed (on) position as shipped.

Fluxing: Per EIA RS-448-2 with flux touching switch body.

Cleaning: Passes immersion test using water/detergent. Acceptable solutions include 1-1-1 trichlorethane, freon, (TF, TE, or TMS), isopropyl alcohol, detergent (140°F maximum). Terpene acceptable for Series 90 only. Solutions which are not recommended include acetone, methylene chloride, freon TMC.

Materials and Finishes

Shorting Member (Ball): Brass, gold-plate over nickel barrier.

Base Contacts: Copper alloy, gold-plate over nickel barrier.

Terminals: Copper alloy, solder-plated over nickel barrier.

Non-Conductive Parts: Thermoplastic (UL94V-O)

Tape and Reel Packaging

Tape Seal Integrity: Passes gross leak test using 125°C flourinert for 20 seconds minimum. Reference MIL-STD-202, Method 112

Tape Seal: Polyimide film

TAPE AND REEL PACKAGING

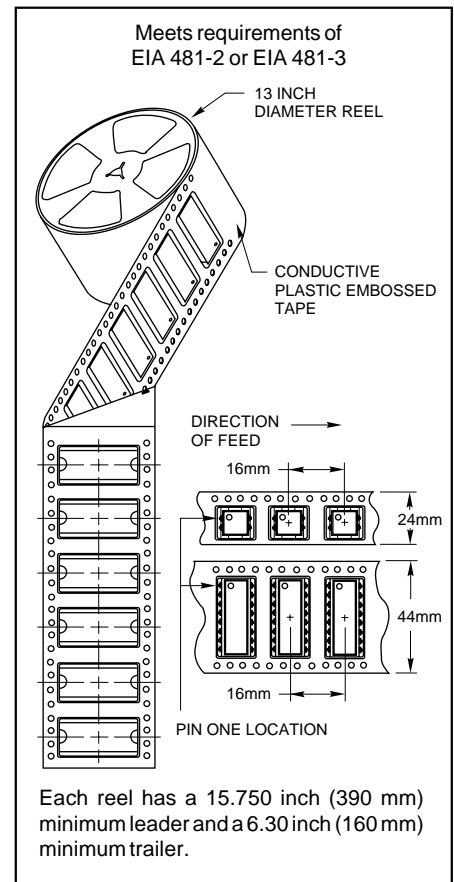

ORDERING INFORMATION

90HBW02PR

Series

Terminal Style: W = Gull Wing, J = J-Bend

Packaging: R = Tape and reel packaging (750 switches/reel)
Blank = Tube packaging (each tube is 19.5" long)

Seal: P = Polyimide Seal
Blank = No Seal

Number of Positions: 02 through 10

No. of Positions	Length Inches	Length Metric	Number Per Tube
2	.270"	6,9 mm	60
3	.370"	9,4 mm	47
4	.470"	11,9 mm	37
5	.570"	14,5 mm	31
6	.670"	17,0 mm	26
7	.770"	19,6 mm	23
8	.870"	22,1 mm	20
9	.970"	24,6 mm	18
10	1.070"	27,2 mm	16

Available from your local Grayhill Distributor. For prices and discounts, contact a local Sales Office, an authorized local Distributor or Grayhill.

DIP Switches