

# General Specifications

Toggles

Rockers

Pushbuttons

Illuminated PB

Programmable

Keylocks

Rotaries

Slides

Tactiles

Tilt

Touch

Indicators

Accessories

Supplement

### Electrical Capacity (Resistive Load)

<b>Switching Rating:</b>	25mA @ 24V DC
<b>Nonswitching Rating:</b>	0.1A @ 50V DC

### Other Ratings

	JS02 Extended Actuator	JS04 Flush Actuator
<b>Contact Resistance:</b>	50 milliohms maximum	50 milliohms maximum
<b>Insulation Resistance:</b>	100 megohms minimum @ 500V DC	100 megohms minimum @ 100V DC
<b>Dielectric Strength:</b>	500V AC minimum for 1 minute minimum	300V AC minimum for 1 minute minimum
<b>Mechanical Life:</b>	2,000 operations minimum	2,000 operations minimum
<b>Electrical Life:</b>	2,000 operations minimum	2,000 operations minimum
<b>Total Travel:</b>	.031" (0.8mm)	.026" (0.65mm)

### Materials & Finishes

	JS02 Extended Actuator	JS04 Flush Actuator
<b>Actuator:</b>	Glass fiber reinforced polyamide	Glass fiber reinforced polyamide
<b>Cover:</b>	Glass fiber reinforced polyamide (UL94V-0)	Glass fiber reinforced polyamide (UL94V-0)
<b>Base:</b>	Glass fiber reinforced polyamide (UL94V-0)	Glass fiber reinforced polyamide (UL94V-0)
<b>Contacts:</b>	Beryllium copper with gold plating	Copper alloy with gold plating
<b>Terminals:</b>	Brass with gold plating	Brass with gold plating

### Environmental Data

<b>Operating Temp Range:</b>	<b>JS02 Extended Actuator:</b> -20°C through +70°C (-4°F through +158°F) <b>JS04 Flush Actuator:</b> -30°C through +85°C (-22°F through +185°F)
<b>Humidity:</b>	90 ~ 95% humidity for 96 hours @ 40°C (104°F)
<b>Vibration:</b>	10 ~ 55Hz with peak-to-peak amplitude of 1.5mm traversing the frequency range & returning in 1 minute; 3 right angled directions for 2 hours
<b>Shock:</b>	50G (490m/s <sup>2</sup> ) acceleration (tested in 6 right angled directions, with 5 shocks in each direction)

### PCB Processing

<b>Soldering:</b>	Reflow Soldering Recommended. See Profile A in Supplement section. Manual Soldering: See Profile A in Supplement section. Note: Switches are packaged in OFF position and should be soldered in OFF position.
<b>Cleaning:</b>	These devices are not process sealed. Hand clean locally using alcohol based solution.

### Standards & Certifications

<b>Flammability Standards:</b>	UL 94V-0 rated cover & base The JS Series slides have not been tested for UL recognition or CSA certification. These switches are designed for use in a low-voltage, low-current circuit. When used as intended in a low-voltage, low-current circuit, the results do not produce hazardous energy.
--------------------------------	--

# Distinctive Characteristics

Extended and flush slide actuators available.

Twin sliding contact mechanism with self-cleaning action (JS02) provides smooth actuation and produces high contact reliability.

Gold plated contacts prevent oxidation and sulfide effect and provide stable contact resistance.

Use of self-extinguishing UL94V-0 certified material in cover and base provides high arc resistance and high insulation resistance.

Gull-wing terminals ensure secure PCB mounting and prevent dislodging during vapor phase and infrared convection reflow soldering.

Terminal spacing conforms to standard PCB grid.  
For JS02: .100" (2.54mm)  
For JS04: .050" (1.27mm)

End-to-end stackable.

Packaged in tape-reel or stick-tube. Tape-reel packaging meets EIA-481-2 Standard.

Coplanarity: all considered surfaces must lie between two parallel planes that are a maximum distance apart of .0059" (0.15mm). (Additional coplanarity details in Terms and Acronyms in the Supplement section.)

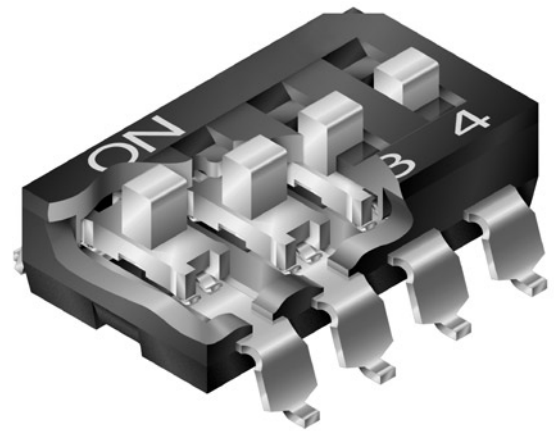

## Actual Sizes

JS02



JS04



### TYPICAL SWITCH ORDERING EXAMPLE

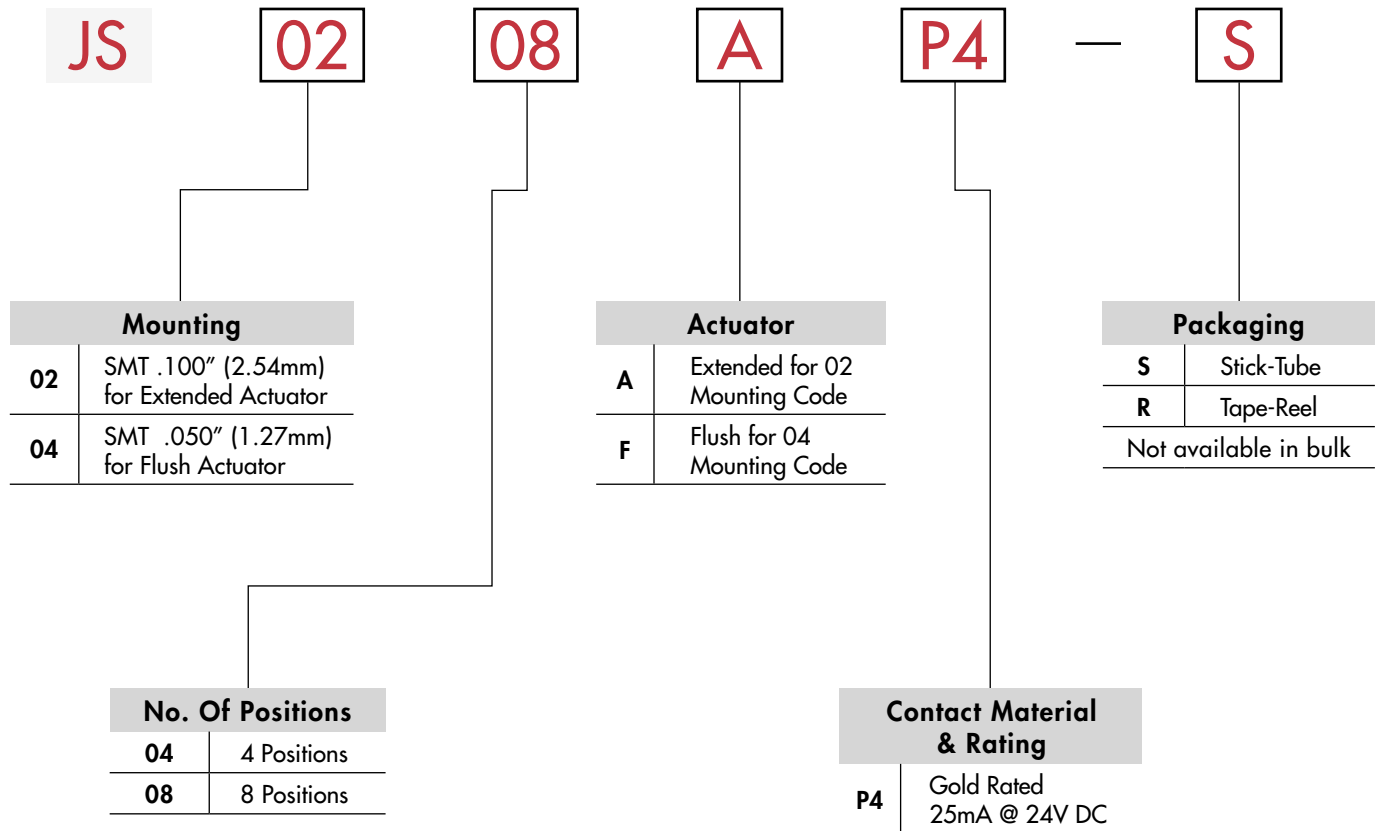

### DESCRIPTION FOR TYPICAL ORDERING EXAMPLE

#### JS0208AP4-S

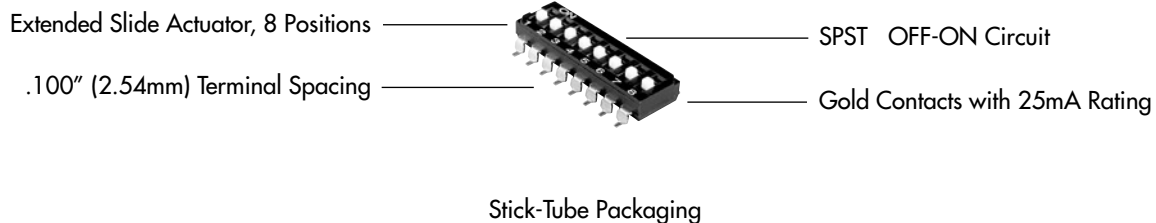

TYPICAL SWITCH DIMENSIONS

Single Pole

4 Positions • Extended Actuator

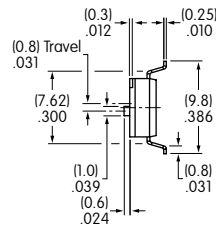
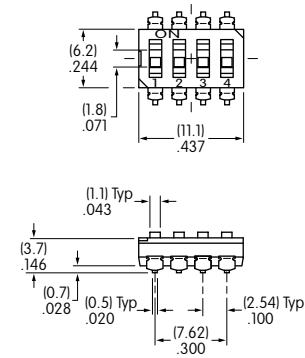

End View

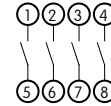
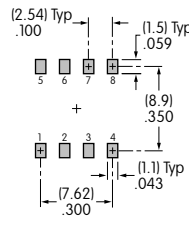

Schematic

JS0204AP4

Single Pole

8 Positions • Extended Actuator

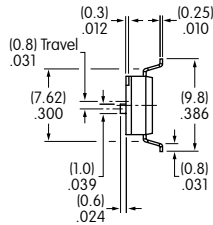
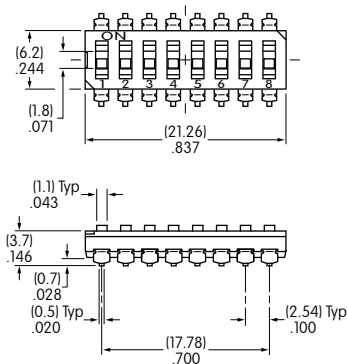

End View

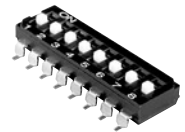
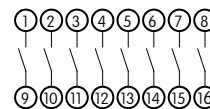
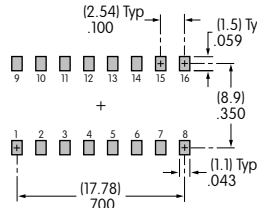

Schematic

JS0208AP4

Single Pole

4 Positions • Flush Actuator

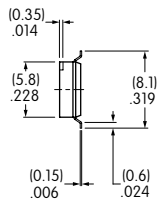
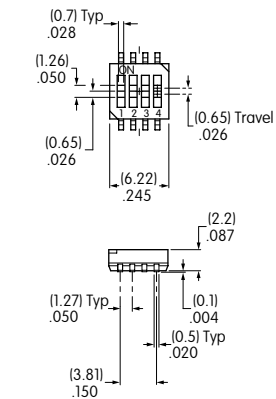

End View

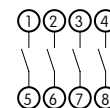
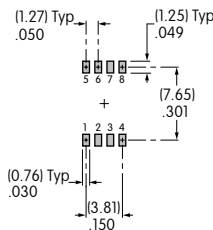

Schematic

JS0404FP4

Single Pole

8 Positions • Flush Actuator

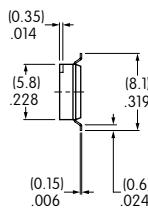
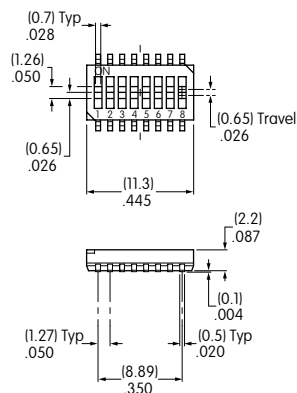

End View

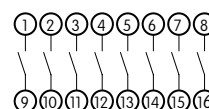
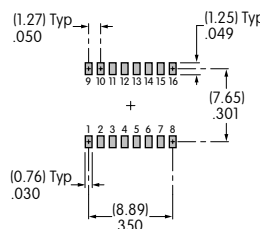

Schematic

JS0408FP4

### PACKAGING

**S**

#### Stick-Tube Packaging

Switches are packaged in OFF position.  
Switches are not available in bulk and must be ordered in the following increments:

##### Extended Actuator

JS0204AP4-S: 46 pieces per stick-tube  
JS0208AP4-S: 24 pieces per stick-tube

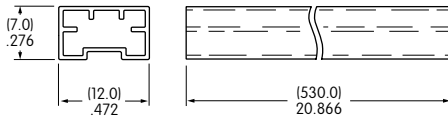

##### Flush Actuator

JS0404FP4-S: 80 pieces per stick-tube  
JS0408FP4-S: 45 pieces per stick-tube

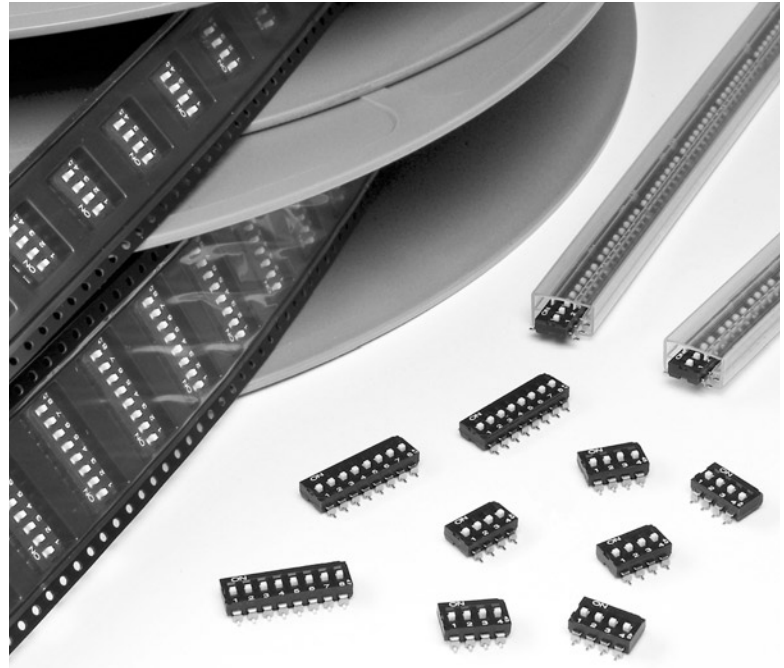
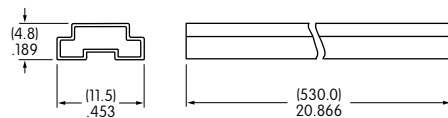

**R**

#### Tape-Reel Packaging for Extended Actuator

Switches are packaged in OFF position.  
Switches are not available in bulk and must be ordered in the following increments:

JS0204AP4-R: 500 pieces per tape-reel  
JS0208AP4-R: 500 pieces per tape-reel

Minimum Leader Length: 15.75" (400mm)  
Minimum Trailer Length: 6.3" (160mm)

Tape-reel packaging meets EIA-481-2 Standard.

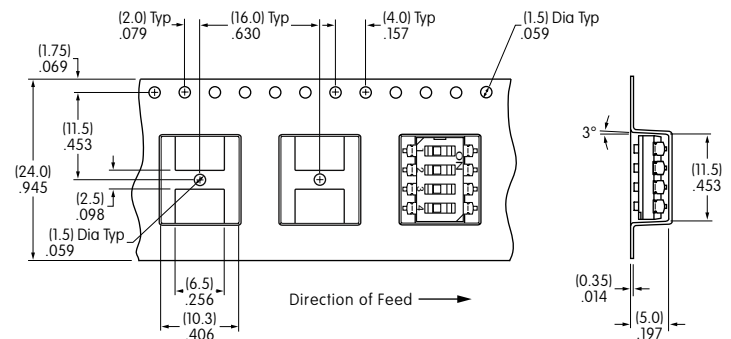

Tape Dimensions for JS0204AP4-R

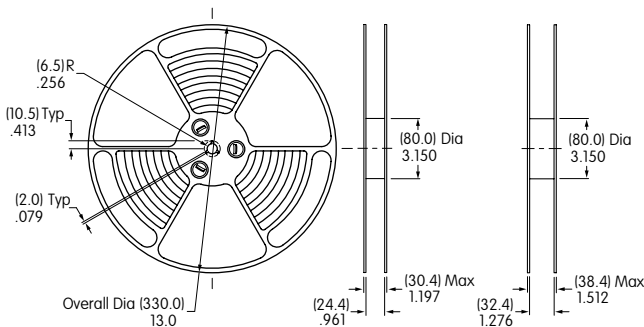

Reel Dimensions JS0204AP4-R JS0208AP4-R

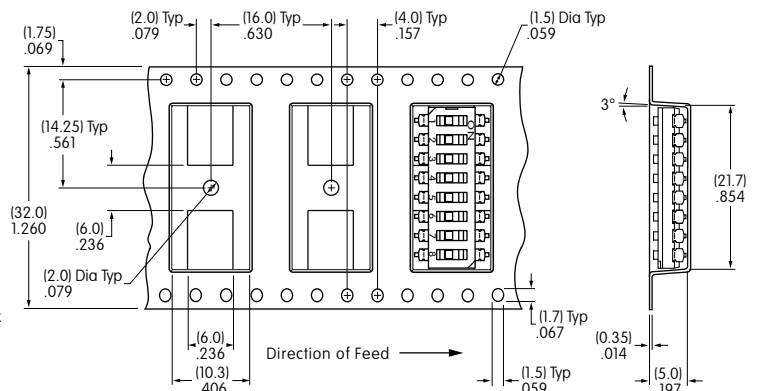

Tape Dimensions for JS0208AP4-R

PACKAGING (CONTINUED)

**R**

**Tape-Reel Packaging for Flush Actuator**

Switches are packaged in OFF position.  
Switches are not available in bulk and must be ordered in the following increments:

- JS0404FP4-R: 2,000 pieces per tape-reel
- JS0408FP4-R: 2,000 pieces per tape-reel

Minimum Leader Length: 15.75" (400mm)  
Minimum Trailer Length: 6.3" (160mm)

Tape-reel packaging meets EIA-481-2 Standard.

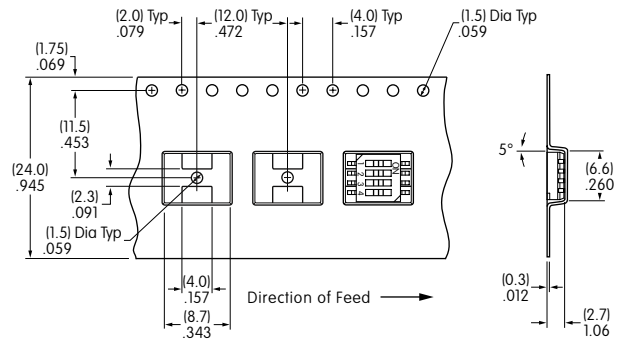

Tape Dimensions for JS0404FP4-R

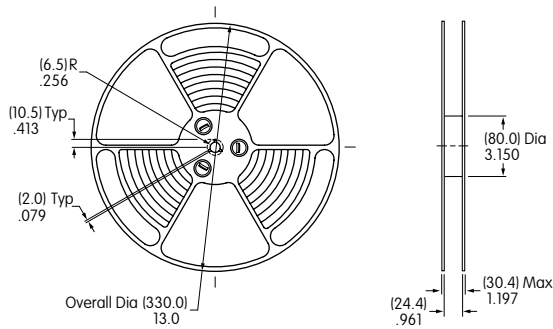

Reel Dimensions for JS0404FP4-R & JS0408FP4-R

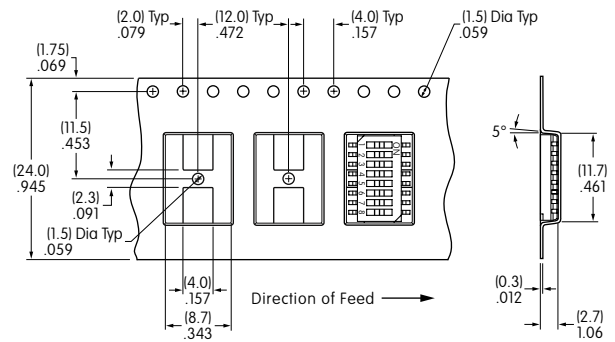

Tape Dimensions for JS0408FP4-R

- Toggle
- Rockers
- Pushbuttons
- Illuminated PB
- Programmable
- Keylocks
- Rotaries
- Slides
- Tactiles
- Tilt
- Touch
- Indicators
- Accessories
- Supplement